

60c ■ FEB. 1972

Radio-Electronics

FOR MEN WITH IDEAS IN ELECTRONICS

TRANSISTOR TESTING IS A CINCH

**Exciting New World
Of The Liquid Crystal**

**Experiment with a
Binary Counting Demonstrator**

**Build Don Lancaster's
Dual-Clock Generator**

All About Electrolytics

350796 TOK 01064095 NOV73 2 A
02 4
H L THOMAS
106 SE 48TH ST
GAINESVILLE FL 32601

GERNSBACK
PUBLICATION

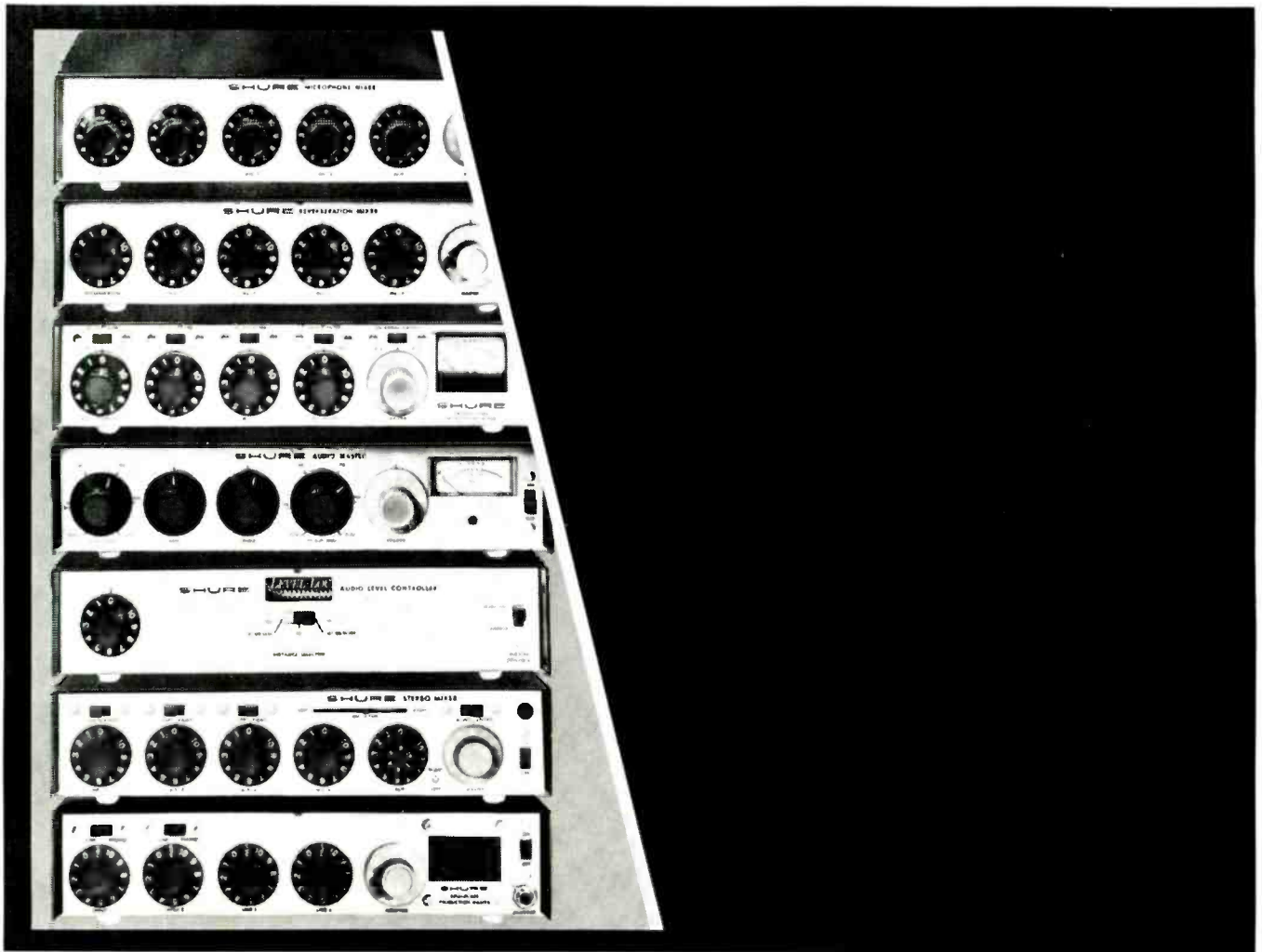

The Magnificent Seven



We've been hearing unsolicited rave reviews from soundmen across the country concerning our seven ingeniously versatile problem-solving audio control components (1) *M68 Microphone Mixer*, vanguard of the low-cost, high-performance portable mixers; (2) *M68-RM Mixer*, with built-in reverb for vocalists and special effects; (3) *M67 Mixer*, the trail-blazing low-cost professional mixer; (4) *M63 Audio Control Center*, that gives you variable response shaping; (5) *M62V Level-Loc*, the audio level controller that automatically limits output level; (6) *M688 Stereo Mixer*, made to order for stereo recording and audio-visual work; and finally, (7) *M675 Broadcast Production Master*, that teams up with our M67 to give a complete broadcast production console (with cuing) for under \$325. Write for the new Shure Circuitry catalog that shows them all:

Shure Brothers Inc.
222 Hartrey Ave., Evanston, Ill. 60204



Circle 1 on reader service card

Another introductory offer to new members of the ELECTRONICS AND CONTROL ENGINEERS' BOOK CLUB

	107/971 ELECTRONIC CIRCUITS: PHYSICAL PRINCIPLES, ANALYSIS AND DESIGN by P. M. Chirlian Pub. price, \$15.50 Club price, \$13.25		286/515 INTEGRATED CIRCUITS: A Basic Course for Engineers and Technicians by R. G. Hibberd Pub. price, \$9.95 Club price, \$8.45
	637/458 DESIGNING WITH TTL INTEGRATED CIRCUITS by Texas Instruments Inc. Pub. price, \$18.50 Club price, \$13.50		497/265 ELECTRONIC SWITCHING, TIMING AND PULSE CIRCUITS, 2/e by Pettit & McWhorter Pub. price, \$12.50 Club price, \$8.95
	404/437 SOURCEBOOK OF ELECTRONIC CIRCUITS by J. Markus Pub. price, \$19.75 Club price, \$14.75		313/059 HANDBOOK OF SEMI-CONDUCTOR ELECTRONICS, 3/e by P. Hunter Pub. price, \$27.50 Club price, \$21.50
	259/607 COMMUNICATION SYSTEM ENGINEERING HANDBOOK by D. H. Hamsher Pub. price, \$29.50 Club price, \$22.50		308/470 ACTIVE FILTERS: LUMPED, DISTRIBUTED, INTEGRATED, DIGITAL & PARAMETRIC by L. P. Huelsman Pub. price, \$16.50 Club price, \$13.95
	158/215 AN INTRODUCTION TO ELECTRONIC COMPUTERS, 2/e by G. B. Davis Pub. price, \$12.50 Club price, \$9.30		124/035 HANDBOOK OF PHYSICS, 2/e by Condon and Odishaw Pub. price, \$34.75 Club price, \$14.95
			494/754 ENGINEERING MANUAL, 2/e by R. H. Perry Pub. price, \$12.50 Club price, \$9.95
			654/301 ENGINEERING MATHEMATICS HANDBOOK by J. J. Tuma Pub. price, \$9.95 Club price, \$8.45
			621/616 WAVE GENERATION AND SHAPING, 2/e by L. Strauss Pub. price, \$16.50 Club price, \$13.95
			209/731 STANDARD HANDBOOK FOR ELECTRICAL ENGINEERS, 10/e by Fink and Carroll Pub. price, \$32.50 Club price, \$24.95

ANY ONE
of these great professional books
for only **\$1.00**
VALUES FROM \$9.95 to \$34.75
Special \$1.00 bonus book comes to you with your first club selection

Save time and money by joining the
Electronics and Control Engineers' Book Club



HERE is a professional club designed specifically to meet your day-to-day engineering needs by providing practical books in your field on a regular basis at below publisher prices.

How the Club operates: Basic to the Club's service is its publication, the *Electronics and Control Engineers' Book Club Bulletin*, which brings you news of books in your field. Sent to members without cost, it announces and describes in detail the Club's featured book of the month as well as alternate selections which are available at special members' prices.

When you want to examine the Club's feature of the month, you do nothing. The book will be mailed to you as a regular part of your Club service. If you prefer one of the alternate selections—or if you want no book at all for that month—you notify the Club by returning the convenient card enclosed with each *Bulletin*.

As a Club member, you agree only to the purchase of four books over a two-year period. Considering the many books published annually in your field, there will surely be at least four that you would want to own anyway. By joining the Club, you save both money and the trouble of searching for the best books.

MAIL THIS COUPON TODAY

ELECTRONICS AND CONTROL ENGINEERS' BOOK CLUB
582 Princeton Road, Hightstown, N.J. 08520

Please enroll me as a member of the Electronics and Control Engineers' Book Club and send me the two books indicated below. I am to receive the bonus for just \$1.00, and my first selection at the special Club price shown. These books are to be shipped on approval, and I may return them both without cost or further obligation. If I decide to keep the books, I agree to purchase as few as four books during the next two years at special Club prices (at least 15% below list).

Write Code No. of
bonus book
here

Write Code No. of
first selection
here

Name _____

Address _____

City _____

State _____ Zip _____

E33173

Universal tap simplifies MATV design

by Bert Wolf

Manager Jerrold DSD/ECSD Division

Until now, MATV system design has been somewhat complex. You had to calculate losses in decibels and specify a fixed tap-off isolation value at each receiver location.

The new Jerrold OMNI-TAPS have changed all this. OMNI-TAPS are universal. That is, *any* OMNI-TAP can be used *anywhere* in *any* MATV system. The secret is adjustable isolation, which you can vary simply by turning a screwdriver after the system has been installed.

Aside from simplifying system design, OMNI-TAPS also reduce your inventory problems. Since OMNI-TAPS can be varied continuously over a 12 to 25 dB range, one type of OMNI-TAP replaces three types of conventional tap-offs.

Figure 1, for example, shows a typical 8 story apartment house, older school or hotel, with eight TV outlets per floor. OMNI-TAPS are used for every TV outlet. Because tap insertion loss is very low (average about 0.6 dB per tap at VHF), isolation is adjustable, and Jerrold CAC-6 cable loss is minimal (3.2 dB/100' at VHF), your system calculations are greatly simplified. Just use a Jerrold Gibraltar 3550 amplifier, fed by a Paralog Plus antenna. A new motel or school would be similar, except that trunklines would be run horizontally.

If your particular system is smaller, reduce the number of trunklines and tapoffs, but nothing else. The 3550 is economical enough even for small systems. If the system is bigger, add trunklines and tap-offs, but nothing else. The 3550 can easily handle up to 100 OMNI-TAPS. (For systems over 100 tap-offs, use the 3661 or 3880.)

Choose the antenna as you would an ordinary home TV antenna, except that it usually pays to choose the next larger model. If signals are weak, simply add a Powermate preamplifier.

Figure 1 is a VHF-only system. But adding UHF channels is no problem. Simply use a VU-FINDER PLUS antenna instead of the PARALOG PLUS, and a 4400 82 channel amplifier in place of the 3550. No other changes are required because the OMNI-TAPS,

the splitters and the cable can handle UHF frequencies with no difficulty.

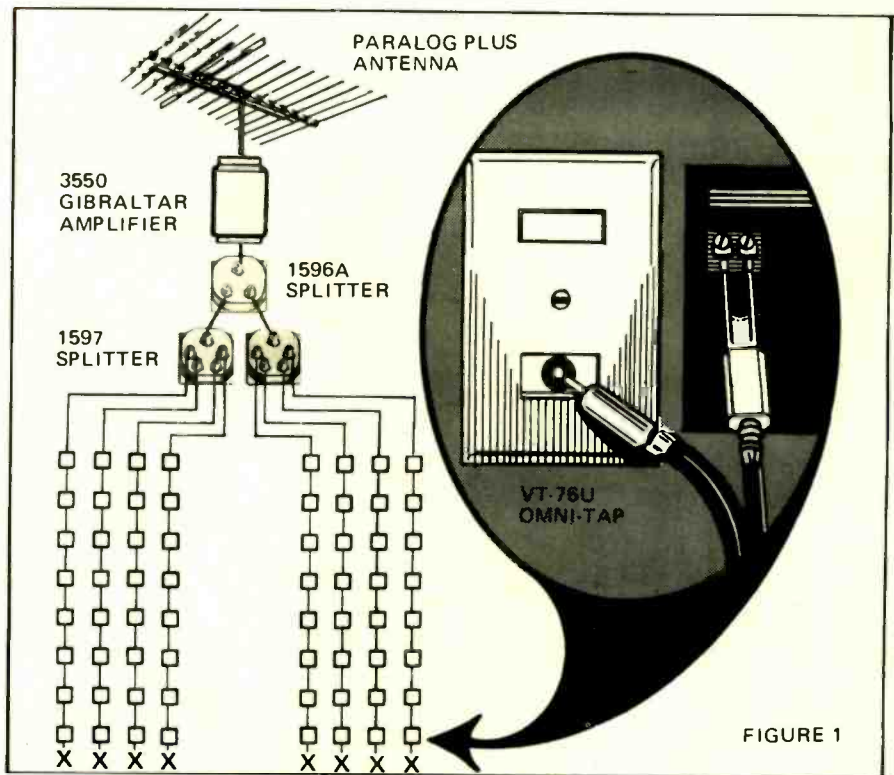

Adjusting Omni-Tap Isolation

Once the system is installed, you have to make sure it works properly. In many cases, no adjustments will be necessary. The OMNI-TAPS will work fine in the system just as you receive them.

In large systems, however, you will have to adjust the OMNI-TAPS so that they provide more isolation near the Head End amplifier than they do at the ends of the trunklines.

There are two ways to adjust OMNI-TAP isolation:

1. With a Field Strength Meter, such as the Jerrold 747. You should have a Field Strength Meter for MATV work anyhow, and this is the easiest way to adjust OMNI-TAP isolation.

Start by turning all of the OMNI-TAPS fully clockwise. For

Circle 3 on reader service card

maximum attenuation. Then, go to a tap in the middle of the trunkline and make sure you can read at least 1000 microvolts of picture carrier signal on the highest channel the system carries. If the reading is less than 1000 microvolts, turn the OMNI-TAP counterclockwise until you get 1000 microvolts. Repeat for each tap until you get to the end of the line.

2. With an Ohmmeter. Connect the Ohmmeter between the arm of the OMNI-TAP potentiometer and the center conductor of the tap output. Set the first four OMNI-TAPS in each trunkline (nearest the Head End) to 700 ohms. Set the next two OMNI-TAPS in each trunkline to 500 ohms. Then, reduce each tap-off in the line by 100 ohms until you get to the end of the line.

For help in laying out a system or solving specific system problems, contact Jerrold via your local Jerrold distributor.

Or, for more information on MATV systems, write Jerrold Electronics, P.O. Box A, Philadelphia, Pa.

Radio-Electronics

FOR MEN WITH IDEAS IN ELECTRONICS

February 1972

TELEVISION

- 37 **Find Bad Transistors Fast**
How to identify and replace unknown transistors with a minimum of test equipment. *by Arthur Cunningham*
- 43 **Kwik-Fix Troubleshooting Charts**
Vertical dynamic convergence. *by Forest H. Belt*
- 51 **Equipment Report**
Hickok CRO 5000 oscilloscope
- 62 **Service Clinic**
Practice what I preach. *by Jack Darr*
- 63 **Reader Questions**
R-E's Service Editor solves reader problems

AUDIO

- 52 **Scope Analysis Of Audio Distortion**
How to use your scope to track down distortion in audio circuits. *by Robert G. Middleton*
- 74 **More Ways To Use Your Tape Recorder**
Some are old, some are new, all are useful. *by Byron G. Wels*
- 77 **Audio Switching System**
Adds versatility to any stereo system. *by Fred Butterfield*
- 91 **Audio Signal Generator**
One-transistor unijunction circuit

BUILD THESE

- 40 **Binary Demonstrator**
Simple device illustrates binary counting. *by Frank Gross*
- 55 **Dual Clock Generator**
Twin-signal source with hundreds of uses. *by Don Lancaster*

GENERAL ELECTRONICS

- 4 **Looking Ahead**
Current happenings. *by David Lachenbruch*
- 24 **Appliance Clinic.**
Light operated solid-state controls. *by Jack Darr*
- 25 **Outwit Electronic Snoopers**
Plug the ears of those electronic eavesdroppers. *by John E. Cunningham*
- 32 **Equipment Report**
Ten-Tec model RX-10 receiver
- 33 **World Of Liquid Crystals**
How they work, what they do, and how they are used as electronic displays. *by Don Lancaster*
- 58 **All About Electrolytics**
Here's how electrolytics are made and used, and how to find and replace bad ones. *by Eugene Cunningham*
- 82 **AC Circuits Nomogram**
Handles series and parallel circuits containing resistance and inductance. *by A. K. Quinn*
- 88 **Laser Experiment**
Coherence of light.

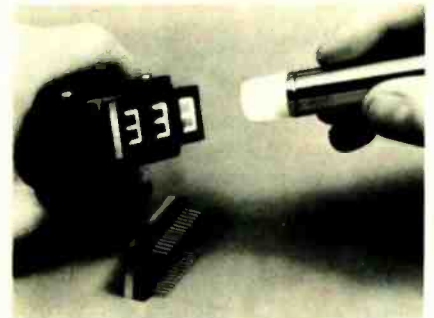

TYPICAL DISPLAY is made from liquid crystals. This is a commercially available unit. For entire liquid crystal story. . . . see page 33

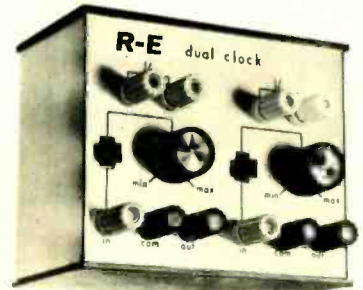

DUAL CLOCK GENERATOR provides test signals for many different useful applications. . . . see page 55

Hugo Gernsback (1884-1967)
founder

M. Harvey Gernsback, editor-in-chief
and publisher

Larry Steckler, editor

Robert F. Scott, W2PWG technical editor

Jack Darr, service editor

I. Queen, editorial associate

Matthew Mandl, contributing editor

David Lachenbruch, contributing editor

James A. Gupton, Jr., photographic electronics

Maxine C. Lipp, editorial assistant

Vincent P. Cicenla, production manager

Nancy Gipson, production assistant

H. Matysko, circulation

Radio-Electronics is indexed in *Applied Science & Technology Index* and *Readers Guide to Periodical Literature*.



Radio-Electronics, February, 1972, Vol. 43, No. 2. Editorial, Advertising, and Executive offices: 200 Park Ave. S., New York, N.Y. 10003. **Subscription Service:** Boulder, Colo. 80302. Second class postage paid at New York City and additional mailing office. Printed in U.S.A.

One-year Subscription rate: U.S. and possessions, Canada \$7. Pan-American countries, \$8. Other countries, \$8.50. Single copies 60¢.

©1972 by Gernsback Publications, Inc. All rights reserved.

POSTMASTER: Notices of undelivered copies (Form 3579) to Boulder, Colo. 80302.

DEPARTMENTS

- | | |
|---------------------------|--------------------------------|
| 16 Letters | 70 New Products |
| 6 New & Timely | 101 Reader Service Card |
| 86 New Books | 93 Technotes |
| 73 New Literature | 91 Try This One |

looking ahead

Super-8 TV

You're going to be able to play your home movies through your color set if two of the world's leading film and camera manufacturers have their way. In addition, they anticipate that a wide variety of educational and entertainment film eventually will be released for a la carte TV viewing. Eastman Kodak has been demonstrating a film videoplayer which it says could be on the market in about two years as an attachment to television sets. Japan's Fuji Photo Film is in pilot production of its own version which it plans to export to the United States late this year. Both units run silently, using continuous-pulldown systems, eliminating intermittent motion and shutter noise common to film projectors. The Kodak version uses an all-electronic shutter system, the Fuji a 16-face revolving prism. Both use flying-spot scanning systems and accommodate cartridge film. Prices will be steep at first—Fuji's is \$750-\$800 in Japan, the Kodak unit may cost as much as \$1,000—but both companies claim prices will come down with the type of quantity production required for the consumer market.

Cable TV thaw

Thaw in the FCC's nearly-seven-year-old CATV freeze is finally in sight, and many cable experts see the beginning of cable TV expansion starting later this year. Broadcasters, cable operators and copyright owners all have agreed to a compromise formula engineered by the White House's Office of Telecommunications Policy. The complex agreement sets guidelines as to which signals may be carried by cable systems in communities of various sizes, and es-

tablishes other ground rules, such as respect for copyrights on programs by cable operators. It will still take some time for the FCC to set out the agreement in terms of formal rules, but it is expected to pave the way for the establishment of new CATV systems in larger cities, which has been banned in the recent past under the Commission's freeze.

4-channel disc war

Just when it appeared that peace was in sight in the battle over quadraphonic record standards (Looking Ahead, *Radio Electronics* January 1972), a real war has broken out. Once again, it's between RCA and CBS, and it could be another struggle reminiscent of the titanic fights over postwar record (45 vs 33) and color TV (compatible vs field-sequential) standards.

CBS, with Sony as its prime manufacturing ally, has introduced and is selling the SQ matrix disc system. Now RCA Records has revealed that it is working to improve some characteristics of the discrete CD-4 four-channel system developed by the Victor Company of Japan and will introduce discs some time this year. (Victor's system was described in *Radio-Electronics* in December 1970.) Allied with RCA Records in this venture are Japanese manufacturers Panasonic and Victor, both owned by the powerful Matsushita Electric Company. Although RCA's own manufacturing arm appears to be taking a less active role, an official statement said it favors the discrete concept and has no plans to market matrix displaying equipment. In the CD-4 system, the two rear channels are modulated on a high-frequency carrier (around 30,000 Hz). The record is compatible with two-channel stereo playing equipment, which simply

ignores the carrier. A CD-4 player uses a special "demodulator" to unscramble the rear channels.

RCA's main effort now is to improve the durability of the four-channel disc when played using a regular stereo cartridge, which tends to destroy some of the four-channel capability. RCA says it has had remarkable success so far toward achieving that goal. The obvious advantage of the RCA system is that it presents four completely independent channels, providing a truer four-channel sound than matrix records, in which front and rear channels are intermixed, with rear channels encoded. It has two principal disadvantages: (1) The playback equipment promises to be more costly than that for the SQ system, since it requires a special high-quality cartridge capable of picking up the 30,000-Hz carrier, in addition to the demodulator. (2) Discrete discs can't be broadcast over stereo-FM stations under current FCC rules, while matrix discs can. Nor can the output of a discrete disc be fed into a standard two-channel tape recorder and played back through a decoder to produce four-channel sound. With SQ discs already on the market under the Columbia Records, Vanguard and Ampex labels, and with equipment being offered by Masterwork, Sony, Lafayette and Sherwood, the RCA-CBS quadraphonic war threatens to intensify in the months ahead. *Radio-Electronics* will present complete details of both CBS and RCA systems next month.

Hotel pay TV

Talk of pay-as-you-watch subscription TV is as old as television itself—and so far it's been mainly talk. The FCC has authorized pay-TV transmission to homes, and perhaps

some pilot projects will get under way soon. But the first working pay TV systems more likely will be in hotel and motel rooms. Two competing systems, in fact, are already well under way—both having undergone test runs, and one of them scheduled to be in regular operation by the time this issue of *Radio-Electronics* appears. Both systems operate in a similar manner. The pay-TV attraction—which could be a first-run movie or a sporting event not broadcast over free TV—is fed via the hotel's master antenna system to all guest rooms in scrambled form on an unoccupied channel. To receive the attraction unscrambled, the hotel guest calls the desk. His picture is unscrambled and the "admission charge" is added to his hotel bill.

The movies will be shown continually throughout the day and evening with staggered starting times, so that at each hour a new film begins.

Both of the systems announced so far will depend largely on movies as their first attractions. One system, developed by a subsidiary of Columbia Pictures, has been tested at the Regency Hyatt House Hotel in Atlanta, and is scheduled to be installed soon in hotels and motels in major U.S. cities and in London. The other system, owned by Computer Television Inc., underwent a long testing period in a motel in Newark, N.J., where it was found that a substantial percentage of guests would gladly pay three dollars to view a current feature film. The films, in color, are transferred to video tape, and shown at specified times. If this new type of pay TV succeeds, it could open up a big new field in maintenance of closed-circuit and video tape equipment for hotels and motels.

R-E

by DAVID LACHENBRUCH
CONTRIBUTING EDITOR

MCR-1211... the tonal truth, and nothing but the truth.

Our trim, new true-fidelity cassette tape recorder. What a beautiful way to break the big-sound/ small-package barrier.

With built-in uniform sound-level control, full-range dynamic speaker, new automatic shut-off that prevents electrical or mechanical damage to tape and machine . . . many other high-value features.

All compactly designed into a lightweight 5½" x 2¾" x 10¼" case. Complete with easy-carry handle, microphone, earphone, Duratape® cassette, four Duracell® batteries . . . ready to play.

The MCR-1211 joins our other two solid-state models for go-anywhere, great-everywhere cassette recording. Try 'em all. See your nearby Mallory Distributor, soon.

MCR-1232
Recorder and superb AM/FM
radio. Total entertainment
in sound. Batteries/
a-c plug-in.

MCR-1204
Neat, easy-to-use, battery-
operated recorder.

MCR-1211
The perfect gift. Simple,
push-button operation.
Batteries/a-c plug-in.



MALLORY

MALLORY DISTRIBUTOR PRODUCTS COMPANY
a division of P. R. MALLORY & CO. INC.
Indianapolis, Indiana 46208

Circle 4 on reader service card

FEBRUARY 1972 • RADIO-ELECTRONICS 5

new & timely



THE CONTENTS OF A LADY'S PURSE show up on a storage-type radiographic amplifier screen.

Radiographic screens

Westinghouse has developed two new solid-state radiographic amplifier screens which quickly convert X-ray images into visible images with energy gain. The screens are available in both storage and nonstorage types for industrial non-destructive testing and for special medical applications.

The storage-type amplifier screen displays its visible image for several hours or until it is electrically erased. This permits long, detailed study of an X-ray image without continuous exposure to radiation. The screen can be photographed to keep a permanent record, but no delay for photographic processing is necessary since the screen can be studied directly.

As a direct replacement for existing fluoroscopic screens, the nonstorage radiographic screen has a reasonably fast response so it can effectively view both static and dynamic X-ray images. Its main applications include production line inspections and nondestructive testing. It can be photographed if a permanent

record is needed.

The panels are solid-state photoconductor-electroluminescent types. The photoconductive layer is sensitive to X-rays. The electroluminescent layer provides the visible image and is deposited on top of the photoconductive layer. A voltage is applied across the two layers. When the photoconductive layer is exposed to X-rays, its electrical resistance decreases, causing more of the applied voltage to be dropped across the electroluminescent layer. With this higher voltage applied, the electroluminescent layer emits more light. The light pattern emitted exactly corresponds to the pattern of incident X-rays.

Warranty plan

General Electric has introduced a TV warranty certificate program enabling a consumer to get service on his set anywhere in the country from any of 5,000 franchised service centers registered with the company. Home Furnishings Daily reports that it will not make any difference where the set was purchased, because

under the new program servicing dealers will continue to provide warranty service for their customers, even if the buyer has moved to a different state.

Laser communicator

A new laser communicator, designed to be as easy to use as a pair of binoculars, was developed and demonstrated by the Santa Barbara Research Center, a subsidiary of Hughes Aircraft Company. The self-contained transceiver weighs three pounds, and uses a gallium arsenide laser with output in the infrared. The device operates from a small rechargeable nickel cadmium battery mounted within the body of the receiver unit.

To transmit the signal the operator pulses the laser diode at a reference pulse repetition rate which is then frequency modulated by the voice signal inputs. Each light pulse has a time duration of 100 nanoseconds and reaches a peak power output of ten watts. Pulse transmission is started by talking into a built-in microphone.

The receiving portion of the communicator is optically aligned to receive the transmitted light pulses through a 2.5-inch receiver aperture. The infrared energy received is then processed using special techniques to enhance the signal-to-noise ratio. The pulses are amplified and the repetition rate demodulated to convert the received pulses into audio or data signals.



Because of its wide-angle transmitter beam design, the communicator may be used under any conditions that allow the
(continued on page 12)

new dimensions



in electronics

NOW AVAILABLE FOR IMMEDIATE DELIVERY

the versatile PHASE solid state

AUDIO SWEEP GENERATOR

SPECIFICATIONS & FEATURES

Functions: sine, square, triangle, positive and negative sawtooth with variable slope control

Controls: range, frequency, functions, attenuator, sweep speed (VCO frequency), VCO amplitude

Frequency Range: 0.02 Hz. to 20 KHz. - all functions

Dial Accuracy: better than 2% linear

Power: 115 vac, 50/60 Hz.

Output Impedance: 50 OHMS

Output Voltage: 0-10 volts, peak-peak

Sweep Speed: variable 1/25 sec. - 10 sec.

Sweep Width: continuously variable maximum; 20Hz. - 20KHz. minimum; zero!

Waveform Distortion: less than 1% (sine, square, triangle)

Frequency Response: 20Hz - 20KHz \pm 1 db

Frequency Stability: 0.1% per $^{\circ}$ C (0-50 $^{\circ}$ C)

Square Wave Rise Time: less than 80 ns.

Triangle Linearity Error: less than 0.5%

VCO Access: use the ASG-200 to trigger other equipment, or use other outputs to trigger the ASG-200!

Added Features: smooth continuous sweep, no external inputs needed, short-circuit proof!

Dimensions: 4-3/4 in. high, 8-1/4 in. wide, 6-1/2 in. deep

Weight: 48 ounces



Continuously sweeps the entire audio range ELECTRONICALLY!!

Or use it as a function generator

Used with your oscilloscope, you can measure the frequency response of amplifiers, etc., quickly and accurately. You will see the amplifier response curve instantaneously! Eliminates point by point graphing!

The incredibly low price of \$108.09

includes factory assembly and testing, a two year warranty, and a ten day money-back guarantee if not satisfied for any reason!

Also available as kit: \$84.85

CIRCUIT BOARDS in 10 Minutes ?

with just a pair of scissors



Pressure Sensitive Copper Foil Tape and Sheet

- No Chemicals — No Mess
- No Layout Restrictions
- Full Instructions
- Simple Circuit Changes
- Flexible — Conforms to any surface shape
- Use for Crossovers — Either insulate with Teflon or Mylar or use other side of board.

5 feet 1/16" or 1/8" wide \$.60
 100 feet 1/16" or 1/8" wide \$9.95
 Sheets 6" x 12" — \$2.50 each
 or 5 for \$9.95

Order Now

Cir-kit

A division of PHASE CORPORATION

PHASE CORPORATION Dept. 862
 315A Boston Ave., Medford, Mass. 02155

SHIP ORDER TO: _____

Check Enclosed For: \$ _____

Charge My Master Charge # _____

Charge My Bank Americard # _____

Ship C.O.D. _____

Mass. Residents Add 3% Sales Tax

quan	item	desc	price
	ASG-200	assembled	108.09
	ASG-200	kit	84.85
	CIR-KIT	1/16" 5 ft.	.60
	CIR-KIT	1/8" 5 ft.	.60
	CIR-KIT	1/16" 100ft.	9.95
	CIR-KIT	1/8" 100ft.	9.95
	CIR-KIT	6"x12" sheet	2.50
		pkg of 5 sheets	9.95

we pay shipping on all cash orders

Circle 5 on reader service card

firsts

**make learning
Electronics at home
fast and fascinating—
give you priceless
confidence.**

Some NRI **firsts** in training equipment



first to give you Color Television training equipment engineered specifically for education—built to fit NRI instructional material, *not* a do-it-yourself hobby kit. The end product is a superb Color TV receiver that will give you and your family years of pleasure. You “open up and explore” the functions of each color circuit as you build.



first to give you a unique, exciting digital computer *with memory* built especially for home training. You learn organization, trouble shooting, operation, programming as you build and use it. Performs the same functions as commercial computers. Lessons stress computer repair. You conduct a hundred experiments, build hundreds of circuits. A solid-state VTVM is included among ten training kits.

NRI's "discovery" method is the result of over half a century of leadership simplifying and dramatizing training at home

The FIRSTS described below are typical of NRI's half century of leadership in Electronics home training. When you enroll as an NRI student, you can be sure of gaining the in-demand technical knowledge and the priceless confidence of "hands-on" experience sought by employers in Communications, Television-Radio Servicing and Industrial and Military Electronics. Everything about NRI training is designed for your education . . . from the much-copied, educator-acclaimed Achievement Kit sent the day you enroll, to "bite-size" well-illustrated, easy to read texts programmed with designed-for-learning training equipment.

YOU GET YOUR FCC LICENSE OR YOUR MONEY BACK

There is no end of opportunity for the trained man in Electronics. You can earn \$6 or more an hour in spare time, have a business of your own or qualify quickly for career positions in business, industry, government. And if you enroll for any of five NRI courses in Communications, NRI prepares you for your FCC License exams. *You must pass* or NRI refunds your tuition in full. No school offers a more liberal money-back agreement. The full story about NRI leadership in Electronics training is in the new NRI Catalog. Mail postage-free card today. No salesman is going to call.
NATIONAL RADIO INSTITUTE, Washington, D.C. 20016

APPROVED UNDER NEW GI BILL If you have served since January 31, 1955, or are in service, check GI line on postage-free card.

designed from chassis up for your education



first to give you true-to-life experiences as a communications technician. Every fascinating step you take in NRI Communications training, including circuit analysis of your own 25-watt, phone/cw transmitter, is engineered to help you prove theory and later apply it on the job. Studio equipment operation and troubleshooting become a matter of easily remembered logic.



first to give you completely specialized training kits engineered for business, industrial and military Electronics. Shown above is your own training center in solid state motor control and analog computer servo-mechanisms. Telemetering circuits, solid-state multi-vibrators, and problem-solving digital computer circuits are also included in your course.

use of binoculars, its range being dependent on visibility and the degree of divergence desired. Possible applications include ship-to-ship communications, riot control, tower-to-tower transmission in the forestry service, and various battlefield uses.

Hugo Gernsback scholarship winner

Career Academy has awarded its Second Annual Hugo Gernsback Scholarship for 1972 to Gordon E. Shepard of Ionia, Michigan. Gordon receives \$125.00 from **Radio-Electronics** as an outstanding student at one of eight home-study schools of electronics.



When he completed high school Gordon went to work as a welder at General Motors, but, after two years, enrolled with Career Academy's home-study program to pursue his major interest, electronics. Although he says he has acquired enough knowledge now to hold a better job, Gordon is planning to study full-time to learn still more in his field.

Two-way cable TV system

A one-year pilot trial of a complete two-way cable television system at Cape Cod, with about 200 homes participating, has shown that the idea of an interlinked city is a practical possibility. Redifusion International Ltd., a British firm, is offering the system to operators of telephone and TV cable systems in the United States.

Called *Dial-a-Program*, the setup offers subscribers variety in information and entertainment, including access to facsimile reproduction of newspapers, to film and tape libraries and university-linked networks, and to programs for particular regions or ethnic groups within a community. Subscribers could communicate with their banks, with supermarkets and other businesses, and computers could "talk" to computers.

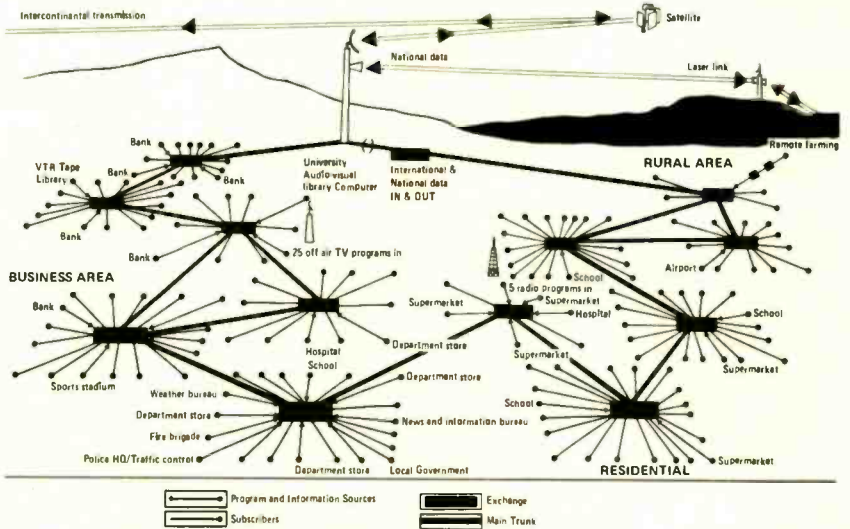

The system works somewhat like a conventional telephone network. Color or back-and-white standard TV sets can be connected to a local program exchange by two pairs of wires, one of TV bandwidth quality (5 to 10 MHz) and another slightly lower-grade pair which can be used for very high speed data, speech, control and other purposes. Signals can be carried on

the high-grade pair in both directions simultaneously using different frequency channels. In this way programs may be originated at one subscriber's studio or home and relayed to others via the exchange.

An ordinary telephone-type dial that actuates a reed selector switch designed *(continued on page 14)*

Radio-Electronics is published by Gernsback Publications, Inc. 200 Park Ave. S. New York, N.Y. 10003 (212) 777-6400
President: M. Harvey Gernsback
Secretary: Bertina Baer

ADVERTISING SALES

EAST
Stanley Levitan, Eastern Sales Mgr.
Radio-Electronics
200 Park Ave. South
New York, N.Y. 10003
(212) 777-6400

MIDWEST/Texas/Arkansas/Okla.
The Ralph Bergen Co.
6319 N. Central Ave.
Chicago, Ill. 60646
(312) 792-3646

PACIFIC COAST/Mountain States
J.E. Publishers Representative Co.,
8560 Sunset Blvd.,
Suite 601,
Los Angeles, Calif. 90069
(213) 659-3810
420 Market St.,
San Francisco, Calif. 94111
(415) 981-4527

SOUTHEAST
E. Lucian Neff Associates
25 Castle Harbor Isle,
Fort Lauderdale, Florida 33308
(305) 566-5656

SUBSCRIPTION SERVICE: Send all subscription orders and correspondence to **Radio-Electronics**, Subscription Department, Boulder, Colo. 80302

MOVING? For change of address allow six weeks, furnishing both the old and new addresses and if possible attaching label from a recent issue. Otherwise please print clearly your name and address exactly as it appears on your label.

ATTACH LABEL HERE

name _____ (please print)
address _____
city _____ state _____ zip code _____

Mail to: **Radio-Electronics**
SUBSCRIPTION DEPT., BOULDER, COLO.
80302

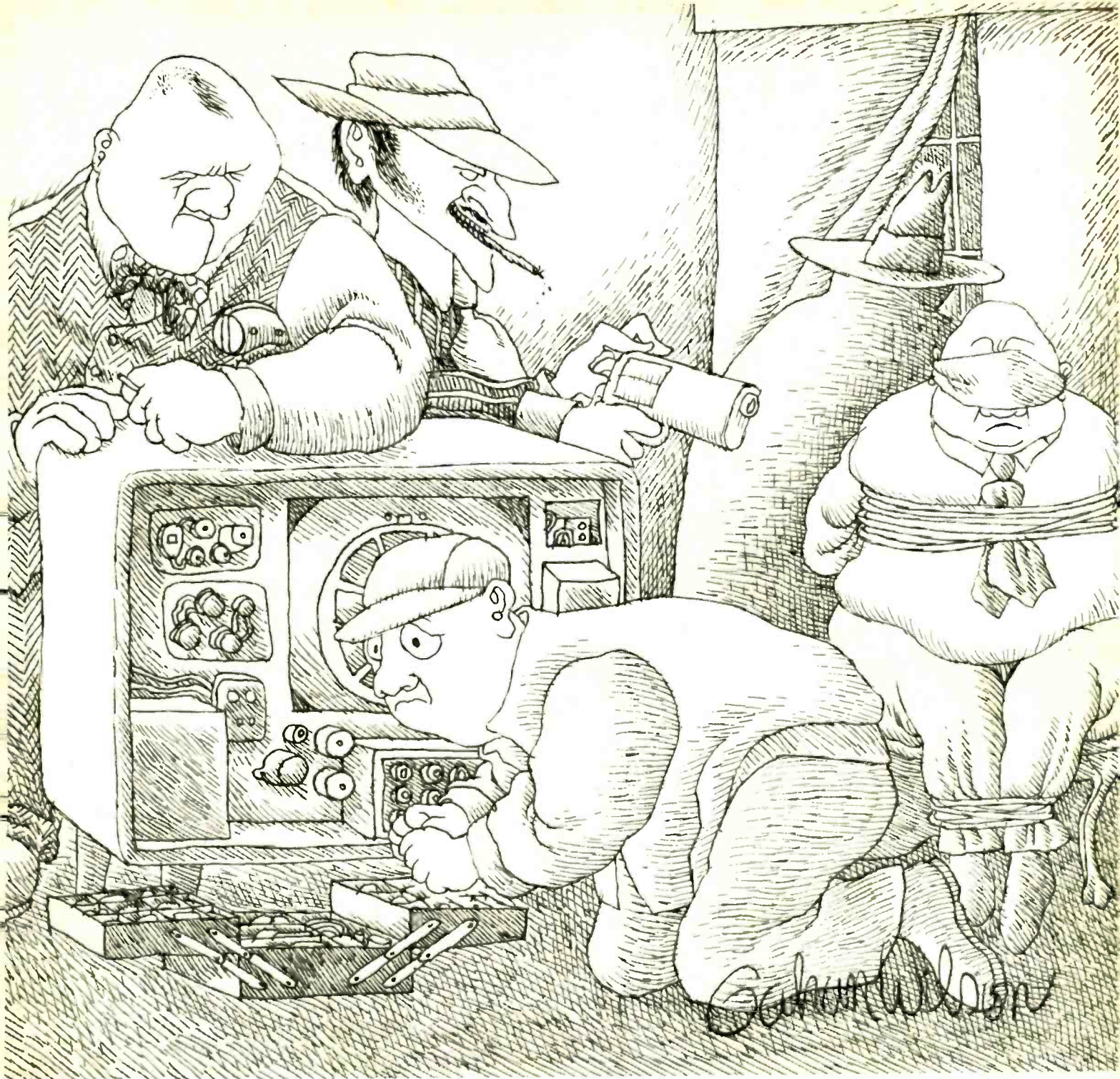

When you're in a hurry, it's nice to know GTE Sylvania has the parts.

Only 34 tubes and ECG solid-state components will solve practically all of your high-voltage rectifier replacement problems.

And they're all available from your Sylvania distributor.

Because tubes are tubes, we can't promise to reduce the number you'll have to carry. But, with the Sylvania line, your distributor will have the tube you need when you need it.

In semiconductors, the story is different. Just 124 ECG solid-state devices including transistors, diodes and integrated circuits will replace over 41,000 differ-

ent types. In the high-voltage section alone, only 8 ECG rectifiers and triplers will take care of almost every job.

And they save a lot of space in your tube caddy.

When your distributor is stocked with Sylvania receiving tubes and ECG semiconductors you'll have the parts you need. And you'll get them fast.

It's like having a complete warehouse built into your telephone.

And that should help you make a fast getaway.

GTE SYLVANIA

for 36 channels is used to select programs. An individual selector mechanism permits record-keeping of audience rated figures and subscriber money paid or due.

Local exchanges, each covering about fifteen city blocks, would be linked by a coaxial cable network of circular trunk routes. Signals starting at any point in the system could be injected at any program exchange and circulated throughout the network or retained within a local loop.

Rediffusion's system requires the installation of a simple cable, known as "Qwist", which carries both audio and video. In effect, it extends the technology of the telephone to the point where full band width for color transmission is carried on a wide bandwidth which is two-way and switched.

Expected cost to the subscriber will lie in the range of \$5 to \$6 per month, to cover all the broadcast channels an operator could pick up off the air. Other channels could be rented to anyone interested in communicating visually with the public.



A Raytheon plan view display is given a microscopic examination prior to acceptance tests by the U.S. Federal Aviation Administration. The high resolution screen displays aircraft information and movements clearly in alphanumeric characters and lines considered superior to air traffic control displays currently in use.

Alec Reeves dies

The developer of pulse-code modulation, Alec Harley Reeves, died of cancer on October 14th. He was 69 years old. Best known for his revolutionary method of transmitting telephone conversations, other electronic messages or data, Dr. Reeves spent his entire professional career, until retirement, with International Telephone & Telegraph Corporation (ITT). He left no family.

Dr. Reeves was born in England in 1902, graduated from London University,



Laser resistor-trimming set-up at Motorola. Resistors on hybrid circuit substrates are trimmed to tight ohmic tolerance by a laser beam which cuts into the film resistors used. The TV monitor displays hybrid circuit workpiece, while the computer/measurement system (on the right) monitors and controls the trimming operations.

and was a member of the British Institution of Electrical Engineers. At ITT he worked on the first transatlantic radiotelephone system. Later he aided in implementing the first Spain-to-South America high-frequency radio link and the first microwave radio system across the English Channel. During World War II he developed the "Oboe" radio navigation system, for which he was made a Member of the Order of the British Empire in 1945.

First case of healing fractures by electricity reported

University of Pennsylvania surgeons have reported the first successful case of healing a bone fracture in a human by electricity. The research, begun nine years ago, has culminated with repair of an ankle fracture in a 51-year-old woman. Details on the technique were reported in *New & Timely*, July 1971, *Radio-Electronics*.

Peruvian government seizes TV

The revolutionary military government of Peru has taken control of the TV and radio industry. The reasons given by the Minister of Communications and Transport, Brig. Gen. Anibal Meza Cuadra were basically that the 19 TV and 222 radio stations were in the hands of a few families and not designed to aid the cultural, social and economic development of the people; only 36% of the mass media shows are of Peruvian origin, the rest are mostly dubbed programs from the US, Europe, Mex-

ico and Argentina; commercials take up nearly 40% of broadcast time; and most stations are concentrated in a few large urban centers and do not service the majority of people who live in rural areas.

While most industry sources conceded that many of the military's complaints and aims were justified, they denied responsibility for the shortcomings, claiming that the way they ran their stations reflected life in Peru, as well as in many other Latin American countries.

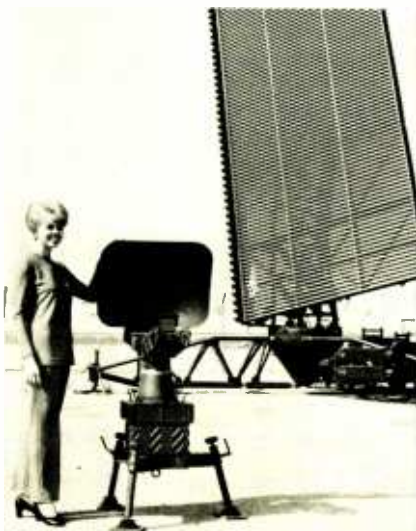

ANTENNAS FOR A US ARMY ground surveillance radar (foreground) and a long-range surveillance radar used by the Marine Corps. Both are developed and produced by ITT. R-E



When you're in a hurry, it's nice to know GTE Sylvania has the parts.

Only 15 tubes and ECG solid-state components will solve practically all of your damper replacement problems.

And they're all available from your Sylvania distributor.

Because tubes are tubes, we can't promise to reduce the number you'll have to carry. But, with the Sylvania line, chances are your distributor will have the tube you need when you need it.

In semiconductors, the story is different. Just 124 ECG solid-state devices including transistors, diodes and integrated circuits will replace over 41,000 differ-

ent types. In the damper section alone, only 3 ECG solid-state devices will take care of almost every job.

And they save a lot of space in your tube caddy.

When your distributor is stocked with Sylvania receiving tubes and ECG semiconductors you'll have the parts you need. And you'll get them fast.

It's like having a complete warehouse built into your telephone.

And that can save you from a real pain in the neck.

GTE SYLVANIA

letters



TOO MUCH TUNING

I would like to take exception to part of the article "Break Through Radio Pollution" by Robert B. Cooper in your June 1971 issue of *Radio-Electronics*.

I'm sure that most of us would rather "tweak and re-tweak" once in a while in preference to adjusting four dials every time we tune in a new station on FM. Mr. Cooper's statement that modern FM sets use one rf stage shows poor contact with the FM broadcast receiver field. Oak Products' FM tuner, which is used in several FM sets on the market, including the Heathkit AR-15, has two rf stages, and FET's in the front end, and has been in production and general use for three years. There is no evidence of front end overloading as a result of large adjacent signals.

The use of printed-circuit coils seems to be a panacea, since we're all going printed-circuit these days, but Mr. Cooper's claim that they are more stable than wire coils is just not true. The best of the printed-circuit material—epoxy glass—has a far higher temperature coefficient of expansion than wire, and therefore would be more unstable. Further, the process of etching the PC leaves very sharp edges on the copper. This, along with the fact that the wire is laid the way it is, leads to very high losses at the edges, and his 1/16 flat wire assumes the proportions of a No. 34 wire or less. This does not contribute to a very high Q in the tuned circuit.

Also, we at Radio Aids have used a tube-type tuner, with much the same characteristics as Mr. Cooper claims for his FET tuner, for 22 years, although we use tubes rather than transistors, of course. Our requirements call for sensitivities in the order of 0.3 μ V for 20 dB silencing at the front end. Our tuner operates with one dial.

HOWARD S. KNAACK
Radio Aids
Lake Bluff, Ill.

MR. COOPER REPLIES

I find that you have not grasped the purpose of my article on the FM pre-amp, and I would like to present a number of facts about etched inductors.

You mention our having a lack of contact with the FM broadcast receiver

Telex headphones and headsets give you that comfortable feeling of assurance when you monitor broadcasts or communications. Signals come through loud and clear — intelligibly and reliably.

Telex professional monaural or stereo headphones incorporate audiometric-type transducers that are impervious to temperature or humidity changes and provide you with absolute performance consistency day in, day out. These sensitive dynamic transducers produce high output levels with minimum consumption of transmission power. Available in single or dual muff configuration and with noise cancelling dynamic or carbon boom microphones.

And you'll never miss a cue or program buss with a Telex Anouncers Earset®. Inconspicuous for 'on camera' work, it has practically become standard in the industry.

Or you can select a Teleset®, Twinset® or Earset® for lightweight, comfortable and inexpensive private monitoring. And for special applications in business or home, industry or institution, Telex makes a listening device to fit your requirements. Available at better sound dealers or write for free information. You'll hear more from Telex.

PRODUCTS OF SOUND RESEARCH
TELEX
COMMUNICATIONS DIVISION
9600 ALDRICH AVENUE SOUTH
MINNEAPOLIS, MINNESOTA 55420



CANADA: DOUBLE DIAMOND ELECTRONICS, LTD., Ontario
EXPORT: ROYAL SOUND COMPANY, INC., 409 North Main Street, Freeport, N.Y. 11520 U.S.A.

Circle 6 on reader service card

field. If you will carefully check my text material, you will find that my reference to a *stage*, such as rf stage, is a semantic term covering a particular function, and not the number of active devices found within that particular section of the receiver. In other words, an rf stage is one in which radio frequency amplification takes place, regardless of whether this is done in one or a dozen active devices, such as a transistor. It is a fact, of course, that virtually all top-of-line FM tuners and/or receivers are today using FET's in the front end. This has been going on for a number of years. What has escaped you is the manner in which these FET's are being used in receivers. I am intimately familiar with their operation. We use them in our lab for reference sources. I am afraid there is considerable evidence of front-end overloading as a result of large adjacent signals. If you have never experienced front-end overloading with modern tuners you simply have not been located close to one or more local FM transmitters. If you "sweep" the rf amplifier section (stages) of these receivers you will probably discover, as we did some years ago, that the 3 dB selectivity points, as measured through the rf amplification stage, are approximately 3 MHz. In other words, signals + or - 1.5 MHz from the frequency the receiver is tuned to are being amplified by the rf stage by not less than 3 dB, reference to the station you think you are tuned to.

Stability in inductors is really a moot question unless you have had the opportunity to work with etched inductors. Stability *can* be measured as a function of rapid temperature and/or humidity changes, or as function of exact repeatability from one device to the next. Within the normal temperature ranges that are experienced by most receiving devices, the coefficient of expansion of wire and glass epoxy board is in a negligible change region and it is unlikely that in either case there is sufficient change to warrant discussion.

On the other hand, in the business of designing and building exact band-pass devices, such as filters or amplified filters, the ability to work with identical inductances from one stage to the next and from one device to the next is exceedingly important. For example, all high-quality laboratory standards band-pass filter devices which use discrete inductors wind these inductances on pre-grooved forms. This is to eliminate the inherent human and mechanical errors which invariably creep into the production process of manufacturing what is supposed to be an identical series of inductors. Even this technique leaves a great deal to be desired.

Our belief in the etched inductors is based on the assumption that when working from a suitable master, each

board containing one or more etched inductances is identical to all boards before. If the board master itself is correct, and can be resonated within the desired frequency range, the production personnel, the alignment technician, and the ultimate user can be assured that each device manufactured using this concept will have performance parameters that are identical to its original production claims and measurement specifications.

In short, the question really becomes one of exact repeatability from one device to another. We believe this is where the etched inductor has a very definite place in the future of electronics.

ROBERT B. COOPER, JR.

CADCO

Oklahoma City, Okla.

IS DOLBY NECESSARY?

Much has been said in your magazine about the application of Dolby processing to FM broadcasting. The whole basis of Dolby (type B) is to boost treble during low-level passages; the response is then flattened during normal or maximum-level passages. A complementary device is supposed to be used to de-process the audio. However, should we assume that there will always be level changes sufficient to derive benefit from Dolby processing?

In my opinion, the typical rock mu-

sic FM station will not receive a benefit from Dolby sufficient to justify the expense. I have actually watched modulation meters at a rock station. Level changes sufficient to activate the Dolby equipment may represent 1% or less of air-time and on some days they may never happen at all!

Many radio stations in this country (rock and others) do not allow drops in audio level: they employ 20 dB or more of automatic volume-compression and an uncertain degree of manual compression (they "ride the gain"). Such stations pride themselves on being "tight"—which is broadcasting slang for allowing no lapses in audio whatsoever.

Many recordings are already highly compressed these days—even many classical recordings. While it is true that Dolby processing may extend the dynamic range of commercial recording, I believe that the final product will always be subjected to compression. This is especially true of rock music.

As a matter of fact, several rock stations on FM in this country are automated and the equipment will automatically reject the very kind of audio which would benefit from Dolby processing. It's called "silence sense" and it's intended never to allow any silence on the air that might result from an

(continued on page 22)

For
faster
service

USE
ZIP
CODE

on
all
mail

TRUE TRIGGERED SWEEP OSCILLOSCOPE/VECTORSCOPE

MODEL TO-50

- DC to 10 mhz frequency response
- .02 volt sensitivity
- Calibrated vertical attenuator
- Calibrated time base
- Supplied with combination Direct/Lo-Cap probe
- 5 X magnifier
- Automatic triggering mode
- 5" flat face tube edge-lit graticule

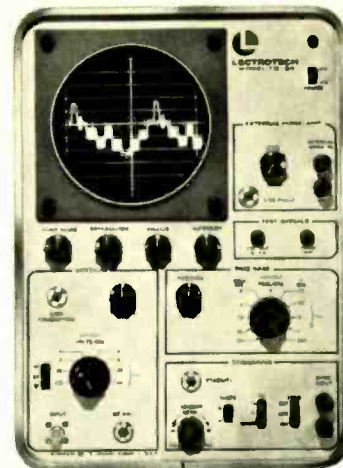

One Year Warranty **339⁵⁰**
Made in U.S.A.



See your distributor or write Dept. RE-2

LECTROTECH, INC.

4529 N. Kedzie Ave., Chicago, Illinois 60625

**“He’s a good worker.
I’d promote him
right now if he had
more education
in electronics.”**



Could they be talking about you?

You'll miss a lot of opportunities if you try to get along in the electronics industry without an advanced education. Many doors will be closed to you, and no amount of hard work will open them.

But you can build a rewarding career if you supplement your experience with specialized knowledge of one of the key areas of electronics. As a specialist, you will enjoy security, excellent pay, and the kind of future you want for yourself and your family.

Going back to school isn't easy for a man with a

full-time job and family obligations. But CREI Home Study Programs make it possible for you to get the additional education you need without attending classes. You study at home, at your own pace, on your own schedule. You study with the assurance that what you learn can be applied to the job immediately.

CREI Programs cover all important areas of electronics including communications, radar and sonar, even cable TV engineering. You're sure to find a program that fits your career objectives.



You're eligible for a CREI Program if you work in electronics and have a high school education. Our FREE book gives complete information. Mail postpaid card for your copy. If card is detached, use coupon at right or write: CREI, Dept. E1201C, Wisconsin Ave. & Tilden St., Washington, D.C. 20016.

Founded 1927

CREI

Accredited Member of the
National Home Study Council



**CREI, A Division of the McGraw-Hill
Continuing Education Company
Dept. E1402C, Wisconsin Ave. & Tilden St.,
Washington, D.C. 20016**

Please send me FREE book describing CREI Programs. I am employed in electronics and have a high school education.

NAME _____ AGE _____

ADDRESS _____

CITY _____ STATE _____ ZIP CODE _____

EMPLOYED BY _____

TYPE OF PRESENT WORK _____ G.I. BILL

- I am interested in:
- Space Electronics
 - Electronic Engineering Technology Computers
 - Industrial Electronics Nuclear Engineering Technology
 - Electronics Systems Engineering
 - Non-technical course in computer programming
 - CATV Engineering

APPROVED FOR TRAINING UNDER NEW G.I. BILL

Need high temperatures in tiny places?

The amazing Little Torch is so tiny it can throw a flame of 6300°F. through the eye of a needle. It solders, brazes, welds and heats with exacting precision in the smallest places; uses oxygen and acetylene,

hydrogen, propane, natural gas or Mapp. It's available with five tips ranging in size from one large enough to weld 16 ga. steel to one small enough to weld .002" copper wire. For free brochure write to:



Dept. 2-SS, 2600 Niagara Lane No., Minneapolis, Minnesota 55441

Circle 8 on reader service card

Now in a mobile unit... DRC*

*DUAL RECEIVE CAPABILITY



New Messenger 323-M

Hottest CB idea since 23-channel operation! DRC lets operator work one channel while automatically monitoring another. 2 monitor channels are switch selectable. Indicator light flashes when call is received on monitored channel. Mode switch selects indicator light only or automatic switching to monitor channel audio. Separate squelch circuits, too.

You're going to hear
more from...



JOHNSON

Waseca, Minnesota 56093

Circle 9 on reader service card

Save Time on PC Board Repairs!



The ENDECO Desoldering Iron Removes Soldered Components in seconds...without damage!

Endeco melts solder; removes last trace by vacuum. Leaves terminals and mounting holes clean. Resolders PC boards better than regular iron. One-hand operation. Temperature controlled for continuous use. Standard tip furnished, 5 other tip sizes. Pays for itself. \$20.65 net. Smaller size available. See your distributor or write:



ENTERPRISE
DEVELOPMENT
CORPORATION

5127 E. 65th · Indianapolis, Ind. 46220

Circle 10 on reader service card

LETTERS

(continued from page 17)

expired tape or a defective machine. However, this gadget is a troublemaker sometimes because it may reject the occasional soft or slow passage in the music. So, as a matter of self-defense, the tapes for the automation are subjected to lots of automatic and manual compression, and even some clipping, during preparation. Then the station compresses the tapes even more on playback. After all this, it goes to the Dolby. I think there will not be many level changes on which the Dolby can operate!

Too many of us are guilty of thinking of FM as it used to be: classical music with wide dynamic range was once FM's specialty. But is this still true today?

I don't agree with those that say that FM benefits from Dolby even if the complementary receiver circuit is not used. If the de-processing is not used the response will not be flat at all times. Isn't a flat response one of the primary objectives of FM? FCC regulations specify more flatness on FM than on AM.

If the FCC rules that Dolby can be used at all times, then they will require that all manufacturers build in the Dolby circuits in all new receivers. This will render obsolete thousands of FM receivers already in use. Nine out of ten receivers in use cannot easily be converted—only those with separate tuners and preamplifiers can be converted with ease. But that kind of set is in the minority today.

Is all the expense and bother really worthwhile? This change would be made for the sake of a minority of listeners with borderline reception. Let me point out that the FCC limits the range of a station by limiting the power which may be used. It is illogical to use a gadget such as Dolby to extend the range, and it is an attempt to bypass the reasons for limiting power.

CLYDE E. WADE, JR.

Little Rock, Arkansas

TIC-TAC-TRONIX

Two problems seem to have crept into my "Tic-Tac-Tronix" article which appeared in the December 1971 issue of **Radio Electronics**. In Figure 3, diodes D1 through D7 should come directly from the base of the first Darlington Transistor. This connection appears correct in Figure 9, Figure 10 and Figure 11.

Integrated circuit IC5 is a 74107. It is correctly called out in the parts list and Figure 11, but is garbled in Figure 5.

Hope these details make construction a little easier for **Radio-Electronics** readers.

DON LANCASTER

R-E

Put More "GO POWER" into Your Electronics Career —

MOVE AHEAD from TECHNICIAN to ASSOCIATE ENGINEER

by studying at home with

GRANTHAM SCHOOL OF ENGINEERING

"the college that comes to you"

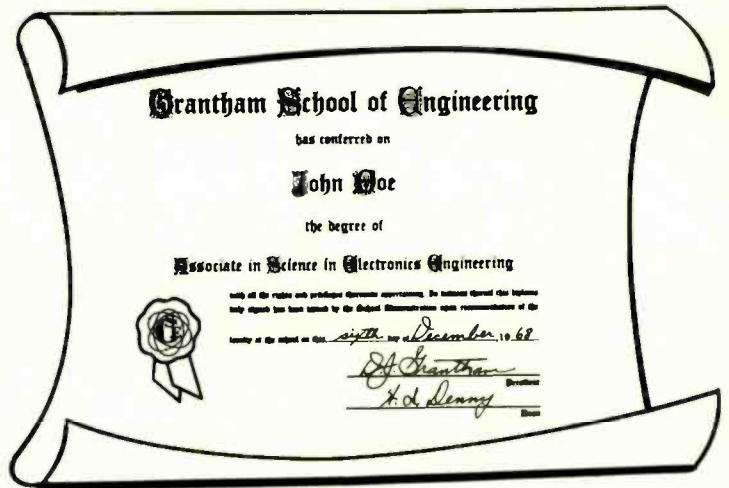

Earn an Associate Degree
in Electronics Engineering

The GRANTHAM educational program in ELECTRONICS ENGINEERING is designed to upgrade electronics technicians to the *engineering* level, mostly by home study.

While you continue your present employment, you can really learn electronics engineering and earn an *ACCREDITED DEGREE*.

GRANTHAM's strong-foundation correspondence program in electronics engineering leads to non-obsolescent skills — to skills based on reasoning — and leads to the DEGREE of Associate in Science in Electronics Engineering (the ASEE Degree). Completion of this program will prepare you for positions normally filled by college-graduate engineers, and for many other electronics careers open to men with the proper training.

This *accredited* degree program for experienced technicians consists of four correspondence courses of 100 lessons each — an overall total of 400 lessons — followed by a two-week graduation seminar held at the School. Upon completion of the four correspondence courses, you are awarded a diploma in Electronics Engineering. Then, upon completion of the two-week graduation seminar, you are awarded the ASEE Degree.

Grantham School of Engineering

• Established in 1951 •

1505 N. Western Ave.
Hollywood, Calif. 90027

Telephone:
(213) 469-7878



What's in Your Future —

The Same Old Job, or Success in Electronics?

Where will you be five years from today? Are you headed for real advancement in electronics, or in a rut? The experience you have is valuable; it gives you a head start toward a better future. But to get ahead and stay ahead, experience must be supplemented with *more education* in electronics and such allied subjects as mathematics, physics, computers, and engineering design.

Accreditation and G.I. Bill Approval

Grantham School of Engineering is *accredited* by the Accrediting Commission of the National Home Study, is *approved* under the G.I. Bill, and is *authorized* under the laws of the State of California to grant academic degrees.

For complete details, mail postcard or coupon.

Grantham School of Engineering RE-2-72

1505 N. Western Ave., Hollywood, Calif. 90027

Please send me your free Bulletin which explains how the Grantham educational program can prepare me for a *degree* in electronics.

- I am a beginner in electronics.
 I have a little experience with electronic equipment.
 I am an experienced electronics technician.

Name _____

Address _____

City _____ State _____ Zip _____

To Troubleshoot FAST & EASY

use: Serviset

Model EC
PATENTED



Intro-Price

\$29.95

Postpaid

FREE
INFORMATION

A precision engineered professional quality electronic test instrument. Ideal for field or bench servicing of all types of Communications gear.

CHECKS: sync, sweep, video, audio circuits, high voltage supplies (DC, RF or Pulse), low voltage supplies, coils, capacitors, resistors, tubes, transistors, diodes, transformers, speakers, etc. Will locate trouble to a particular stage, determine defective component and can actually be clamped in circuit to restore circuit operation temporarily in 80% of component or tube defects. Ideal for locating and confirming intermittents.

SPECIFICATIONS:

RF & AF Signal Tracer, RF & AF Signal Injector, AC & DC Voltage Indicator 0/60/550/20,000 DC Polarity Indicator 60/550/20,000 volts, Lo ohms 0-5, Hi ohms 0-500k-20 megohms. Tests Condensers, .00025-12 mfd., Tests Resistors 2 ohms-20 megohms, 2 Capacitance Sub ranges .01-1 & 4-40 mfd., 3 Resistance Sub ranges 50-500 ohms, 5k-25k, 100k-1 meg.

NEW CT-1

From
Will allow you
to Dynamically test all
types of capacitors.



The Model CT-1 features a built-in electronic power supply providing BOTH AC and DC Test Voltages in a special circuit with highly sensitive NEON type leakage indicator. The CT-1 permits quick, accurate testing of condensers for leakage or shorts with actual DC voltage applied and readily indicates intermittent OPEN condensers with AC applied. Self-regulating power supply circuit provides tapered forming current to suit particular requirements of capacitor under test. Special circuit re-forms and polarizes electrolytic and tantalum capacitors under test. High sensitivity permits determination of condenser dielectric breakdown before leakage causes major shut-down.

Only \$16.95 postpaid

Capacitor Range: .00025 — 1000 mfd.
Sensitivity: Over 200 MEGOHMS

30 DAY MONEY-BACK GUARANTEE

LEE ELECTRONIC LABS., CO.



88 Evans Street
Watertown, Massachusetts 02172

appliance clinic

YOU'RE GOING TO RUN INTO SEVERAL kinds of appliances which are turned on or off automatically by the presence or absence of light. Not too far back, this would have meant a vacuum-tube photocell, an amplifier, dc power supply, relay, and a pretty bulky "package" of electronics. They're getting a lot smaller. There is a solid-state device that can be turned on or off by light, and guess what? It's our old friend the SCR in a new version: two SCR's back-to-back in a single package with a hole in the top, and actuated by light. This is the LASCR.

These are just like phototransistors. Actually, all transistor junctions are photo-sensitive—light falling on 'em makes 'em turn on. All they have to do to make a phototransistor is leave a hole in the top of the case so light can hit the junctions. The LASCR can be turned on by light falling on it. In other words, with light, conduction; no light, no conduction. See any good SCR Handbook for full details.

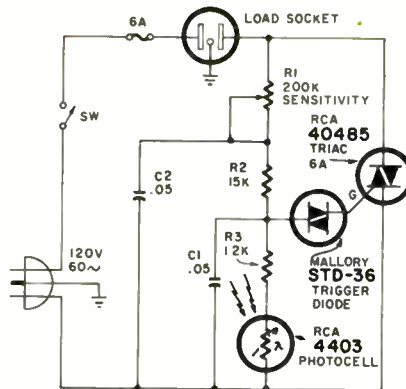

There are applications where we need full-wave conduction. So, we have to use a "double SCR" or "Triac" since the basic SCR cuts off half of the applied ac, like any diode. Also, in a lot of cases, we need an "opposite reaction": turn on when there is no light, turn off when there is. So we add a few little gubbins to the circuit, like the one shown in the diagram, from RCA's "Solid-State Controls" book, and there we are.

What Are They Used For?

There are lots of applications for this kind of thing; automatic yardlights

that turn on at sunset; automatic night lights, room lights, garage door openers, and so on and on. Three resistors, two capacitors, and three solid-state devices and there you are. The RCA 40485 is a 6-amp Triac, so it will handle up to 700 watts or so. There are higher-rated types if needed.

How Does It Work?

When there is no light falling on the 4403 photocell, its resistance is high. So the ac voltage coming through SENSITIVITY control R1 and resistor R2 can charge .05- μ F capacitor C1 to a high voltage, twice during each full cycle. This builds up enough voltage to fire the trigger-diode, which in turn fires the Triac and discharges the capacitor. This is the on condition; whatever load is plugged into the load socket will be energized.

In a yard-light, this would be "night": no ambient light, so the light turns on. When day breaks, the light increases (unless the smog is too thick). The increased light falling on the photocell makes its resistance go away down. Since the photoelectric cell is actually shunted across C1, it prevents the voltage on the capacitor from rising to a level high enough to fire the trigger-diode. So the Triac won't fire either, and the light goes off.

This circuit, as-is, would be all you'd need for an automatic yard-light, etc. It could also be used for things such as counting packages on a conveyor belt, counting people going through a gate to a sporting event, etc.

With an external relay plugged into the load socket, it could be used to start or stop a motor. A relay can open a circuit or close it, depending on which pair of contacts (on a spdt) you use, when its coil is energized.

So this could be "reversed"; made to turn lights on when light hits the photoelectric cell. (For instance, automatic garage lights which turn on when the car's headlights hit the cell) or even a garage-door opener which works when the headlights shine on it, etc.

If anything goes wrong with one of these, servicing is simple. Any of these things can be checked out with an ohmmeter and an ac voltmeter. Just like checking transistors. Look for a short or

(continued on page 69)

The electronic snoopers will resort to anything to listen to your conversations. See how to plug his electronic ears

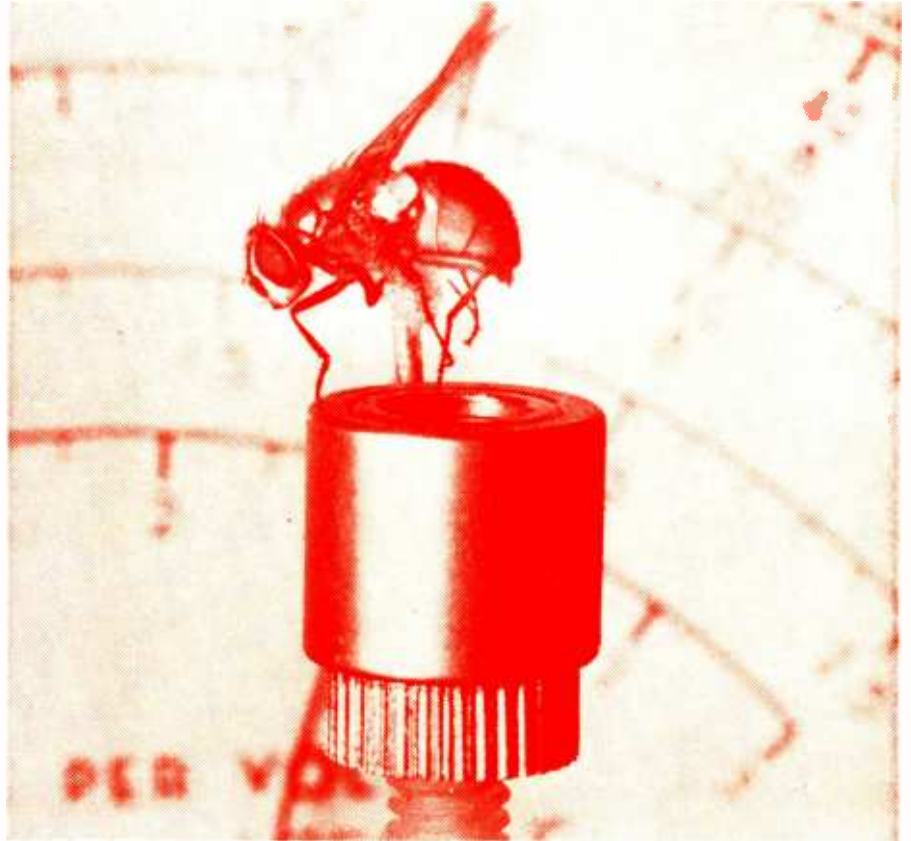

outwit electronic snoopers

by JOHN E. CUNNINGHAM

"BUGGING" OR ELECTRONIC EAVESDROPPING, which was something strictly from science fiction, is a big business in the United States today. You don't hear much about it, because legitimate manufacturers of such devices promote their products primarily to law-enforcement agencies, and makers of illicit bugs prefer to attract as little attention as possible to their operations.

FCC regulations prohibit the sale or use of unauthorized eavesdropping devices, but the fact is that a reasonably effective bug is relatively easy to build. They usually can be readily concealed, and since their signals can only be picked up over a distance of a few hundred feet at the most, it is almost impossible to enforce the regulations.

Bugs have been used by private detectives to gather information for their clients, by employers to eavesdrop on their employees, by businessmen to gain access to their competitors' secrets, and by jealous husbands to check on their wives. In fact, bugs are so easily built or purchased that it is safe to assume that anyone's conversation may be bugged if a person feels it is worth the risk.

This widespread use of eavesdropping devices has led to the development of a new profession—that of the electronic "debugging" expert. Many security consultants spend full time locating bugs and providing secure areas for private business discussions. Furthermore, many electronics technicians are being called in by companies to assure that their secrets are not leaking out to competitors by way of bugs which have been secreted on their premises.

There are four types of electronic eavesdropping devices that are in common use today:

1. High-gain directional microphones.
2. Hidden microphone wired directly to a listening or recording device.
3. Miniature radio transmitters.
4. Bugs used in connection with telephones.

The first type, the high-gain directional microphone, is the easiest to defend against. It is simply a microphone equipped with a parabolic reflector to make it highly directional. Devices of this sort are large and hard to

conceal. Usually, they cannot pick up conversations at distances of more than about 150 feet. The defense is simply to hold conversations in areas with reasonably soundproof walls and closed windows. It also helps to have a distracting source of sound, such as a transistor radio in the room.

The second type is a microphone that is hidden in a room and connected by wires to a remote point where the eavesdropper listens with an amplifier and headphones, or has planted a tape recorder. This type is usually difficult to track down because it doesn't radiate.

By far the most common type of bug is the miniature radio transmitter such as the one shown in Fig. 1. This device is actually a battery-operated transmitter. The eavesdropper merely plants it and then picks up its signal from some convenient place where he is not apt to be noticed.

The fourth, and probably most sophisticated type of bug is the telephone bug. Many different types of telephone bugs are in use. They range from simple wiretaps to radio transmitters hidden in the telephone. The latter are often ar-



FIG. 1—INEXPENSIVE WIRELESS BUG transmits on an unused portion of the standard FM broadcast band.

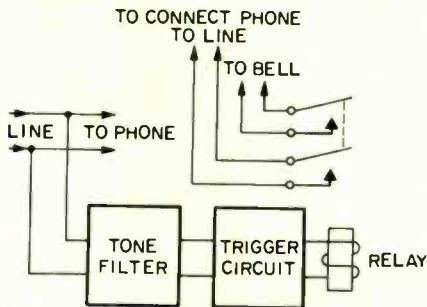

FIG. 2—TELEPHONE BUG CIRCUIT. Caller at listening point turns on phone's mike by dialing number then sending special tone.

ranged to draw power from the telephone line and use the telephone transmitter as a microphone.

A very sophisticated telephone bug, shown in Fig. 2, effectively "answers" the phone before it rings. In this circuit, a tone-operated relay is connected so when a tone of the proper frequency is transmitted on the line, a relay is actuated to disconnect the bell, and connect the transmitter to the line. Once this kind of bug is installed in the victim's phone, the eavesdropper can dial the number from any other phone in the United States. There is a short period of time between the instant that the connection is made and when the bell starts to ring. During this interval, the eavesdropper transmits a tone over the line with a small portable oscillator. The tone prevents the bell from ringing, and connects the victims telephone to the line. The eavesdropper can then listen to all of the conversation in the room from as great a distance as he wishes. The only way that the victim might become aware of the bug is when he fails to get a dial tone when placing a call. Even this usually isn't noticed, because when the eavesdropper hears someone attempting to use the phone he can quickly hang up.

This type of bug is complicated and expensive, but it has the advantage that once the bug is planted, the eavesdropper can listen in almost complete safety, to everything that is taking place.

Debugging techniques

When an electronics technician is called in to locate a bug, or to provide an electronically secure area for private conversations, he must use every bit of ingenuity at his command. The state-of-the-art at the present time seems to be on the side of the eavesdropper.

The first step in debugging a room is to conduct a painstaking and thorough physical search of the premises. This is time consuming, but is usually well worthwhile. Many experts charge fees of up to \$1,000 to assure that a conference room is secure.

When conducting a search, pay particular attention to anything that is new, or temporarily present in the room. A favorite way of temporarily planting a bug is to conceal it in an item of personal property that can be left as though by accident. Thus a competitors representative may leave a briefcase, raincoat, or umbrella containing a bug during a visit to a facility. Many modern bugs are inexpensive and are considered expendable. Sometimes bugs are concealed in gifts such as pictures.

An important factor in debugging an area is the fact that a professional agent rarely plants only one bug. He plants at least two and sometimes more. So if the technician locates a single bug, he should not consider his job done. The bug that he found may have been deliberately planted in a place where it would be easily found to lull the victim into a false sense of security, while another bug is transmitting all of his conversations.

A small metal locator of the type used to locate buried objects is a valuable aid in locating wired microphones that do not radiate.

When a conference room is first built, or at a time that it is known to be secure, make a "map" with the aid of a metal locator showing the location and size of metallic objects. If during a subsequent search with a metal locator,

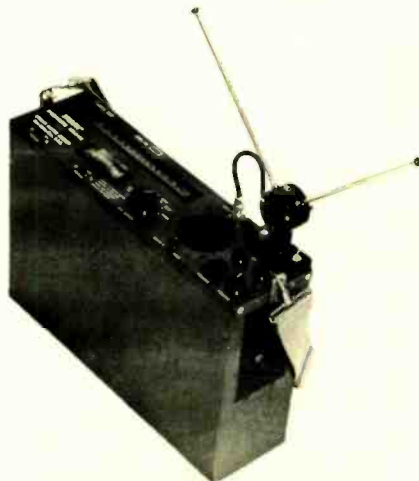

FIG. 3—SPRAGUE INTERFERENCE LOCATOR—vital as a debugging tool—was designed specifically to track down rf signal sources.

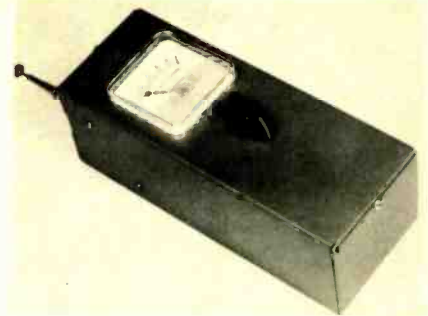

FIG. 4—THE HOUND DOG covers from below 27 to above 108 MHz and responds to both strong signals and weak signals nearby.

new metal objects are detected in the walls, ceiling, floor, or furniture, further investigation is warranted. If no new metal objects are located, carefully inspect existing ones such as lamps, vases, and electrical outlets.

Rf field-strength measurements

Most miniature-transmitter type bugs can be located with rf field-strength measurements. A typical interference locator that has been very effective in locating clandestine transmitters is shown in Fig. 3. The search is often simplified by first carefully examining all signals on frequencies that the eavesdropper is apt to use. The professional will never use a frequency where his bug is likely to be picked up by other users of the spectrum. One bug was located because it was interfering with air traffic communications. Frequencies are usually selected where sensitive receivers are readily available commercially. This factor, together with the fact that short antennas are efficient, has led to a tremendous number of bugs operating in and just outside of the standard FM band of 88 to 108 MHz. Commonly used eavesdropping frequencies are listed in table I.

Amateur eavesdroppers are apt not to be as aware as the professional of the risk of using certain frequencies. They use almost any frequency where they can build small efficient transmitters. This means almost any frequency up to about 200 MHz might be used. The search isn't complete until the entire spectrum has been checked.

Make debugging field-strength measurements by carefully identifying each signal that is picked up in the suspected area. Many bugs use voice-operated relays that turn the bug on only when a conversation is taking place. For this reason, the searcher should talk continuously while making the measurements. Otherwise, the bug might not be radiating while a measurement is made. While making measurements, if the investigator hears his own voice over the field-strength meter, it is a sure sign that a bug is operating in the vicinity.

Another popular debugging meter,

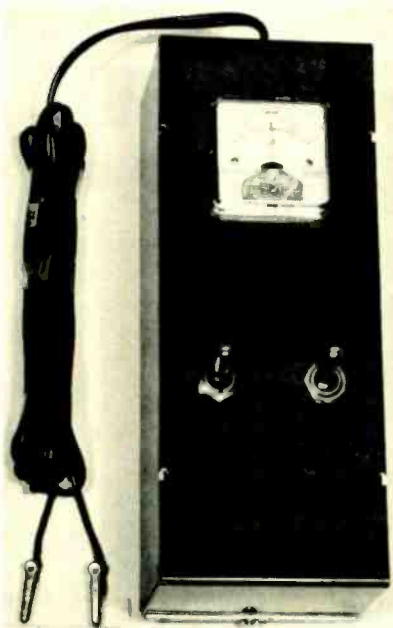

FIG. 5—THE LINE SWEEP detects tones sent over phone line to activate bug. Can be used to detect bugging on local or distant phones.

called the "hound dog" is shown in Fig. 4. This unit is not tuned, but has a broad response to signals from below the Citizens band to above the FM band. Since the majority of bugs operate in or near the standard FM broadcast band, the meter is made most sensitive over this part of the spectrum.

The meter is used to probe the walls, floors, and ceiling of the suspected area, as well as all objects in the area. Its sensitivity is adjusted to provide a minimum reading on signals from local FM and TV stations. When it is brought in close proximity to a bug, the meter indication will rise sharply. This simple meter in the hands of an expert will detect almost any bug of the radio transmitter type.

In areas where there are many strong signals, it is often advisable to make the search after 2 AM when most stations are off the air.

Telephone debugging

Because of the possibility of wire-tapping, a telephone should never be considered completely secure. The phone itself, however, can be debugged. Begin with a thorough search inside the phone for foreign objects. Then make field-strength measurements to detect any transmitter that wasn't discovered

by the physical search.

Tone-operated telephone bugs can be detected with an instrument called the "Line Sweep", shown in Fig. 5. This device is connected to the telephone line and, as its name implies, generates a tone which is swept through the audio spectrum while a meter monitors the line voltage. The voltage on the phone line is normally approximately 50 volts. If while the line is being swept, the polarity of the voltage reverses, it means there is an incoming call.

If while the instrument is sweeping the spectrum, there is a significant dip in the line voltage, there is probably a tone-operated bug on the line. More often than not it will be in the phone itself, but it could be *anywhere along the line*. Once you know there is a bug, it is simply a matter of diligent searching to find it.

The Line Sweep can also be used to check any local or distant phone for the presence of a tone-operated bug.

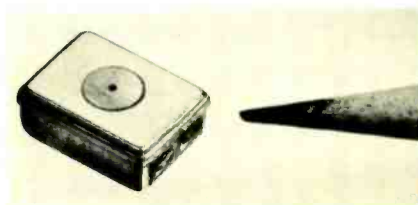

TINY WIDEBAND MIKE measures 0.375 x 0.375 x 0.200 inches. Its output must be amplified for taping or transmission.

Simply advise the party on the other end not to answer his phone and then dial his number. Immediately after the number is dialed, turn on the sweep. After a few seconds of sweeping the line, the ringing sound will stop if a bug is connected to the line.

Automobiles aren't always safe

It is quite easy to bug an automobile. There are plenty of places to hide the bug, and the battery will supply plenty of power to operate a bug that will have a considerable range. The antenna can be passed through a small hole in the body, or in some instances the auto radio antenna has been used.

The proper way to search for a bug in an automobile requires two people—one inside talking continuously to trigger any voice-operated device and the other outside making field strength measurements.



BUGGING TRANSMITTER, concealed in flip-top cigarette pack, has a built-in antenna giving it a range of up to two city blocks.

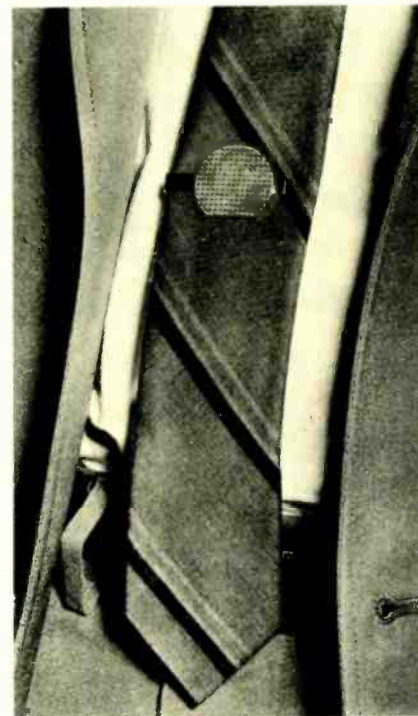

TIE-CLIP MICROPHONE feeds a miniature recorder or into a concealed transmitter to send signal to distant listener or recorder.

Countermeasures

Perhaps the biggest question is not locating the bug, but taking the proper action to restore security. The electronics technician has completed his job when he has either located every bug in an area, or assured himself that there are none. If a bug is discovered, it is up to the proper security authorities to decide what action to take. One common approach, once a bug is located, is to leave it undisturbed, hoping to mislead the eavesdropper with false information. The technician should always check with his client before taking any action.

The names and addresses of manufacturers of debugging equipment are given in Table 2, and further information may be found in the following books:

Security Electronics By J. E. Cunningham, Howard W. Sams

Business Intelligence and Espionage By Richard M. Greene, Dow-Jones Irwin, Inc. Homewood, Ill. R-E

TABLE 1
Frequencies commonly used for bugging

60 - 88 megahertz
88 - 108 megahertz
108 - 110 megahertz
27 - 28.4 megahertz

TABLE 2
Manufacturers of Debugging Equipment

Sprague Electric Company, North Adams, Mass.—Model 600
R. B. Clifton, 11500-W N.W. 7th Ave., Miami, Fla.—Hound Dog and Line Sweep

Great careers

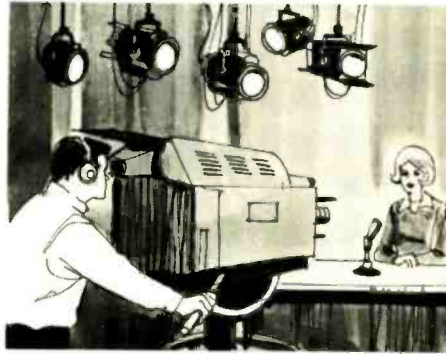

Join the high-paid electronics technicians who got their start through NTS Home Training.

Your home can become your own private classroom-workshop. NTS sends you everything you need to learn valuable technical skills in electronics. You get easy-to-grasp lessons, comprehensive kit manuals, large fold-out charts, and more. Plus the finest professional equipment available today. It's all included in your tuition, yours to keep.

Your equipment is sent to you in kit form, matched to lesson material. With the NTS Project Method, you start with simple projects, then move from basics to more complex concepts. You discover how electronic principles work by performing practical, fascinating experiments. Learn at your own pace.

You quickly become expert in the actual equipment and meth-

ods you'll use on the job. And soon you're ready to cash in on the tremendous opportunities in the expanding, exciting world of electronics!

If your field is television, you might decide to join a first-class TV repair center. Or start a shop of your own. Or specialize in industrial applications of television. Once you master an area of electronics, the direction you take is really up to you. And you'll be able to use the test instruments you built yourself!

It all begins at home, with NTS Project Method Training. Find out how fast and easy it is to learn skills that pay off. Check card or coupon today for your *free* full-color NTS Catalog and complete details. No obligation. No salesman will call.

NTS COLOR AND B&W TV SERVICING

Build the largest, most advanced color TV made! Over-all solid-state design, 315 sq. in. ultra-rectangular screen, matrix picture tube, built-in self-servicing features, "Instant On," A.F.T., solid-state VHF tuner, and much more! Also build and keep AM-SW Radio, Solid-State Radio, FET Volt-Ohmmeter, and Electronic Tube Tester. Learn trouble-shooting, hi-fi, stereo, multiplex systems, radio, color and B&W TV servicing.

Solid-state B&W TV
74 sq. in. picture
(cabinet included)



Learn sophisticated solid-state circuitry as you build this B&W TV receiver. Course covers the full range of home entertainment electronics.

begin at home.



New solid-state
315 sq. in. color TV

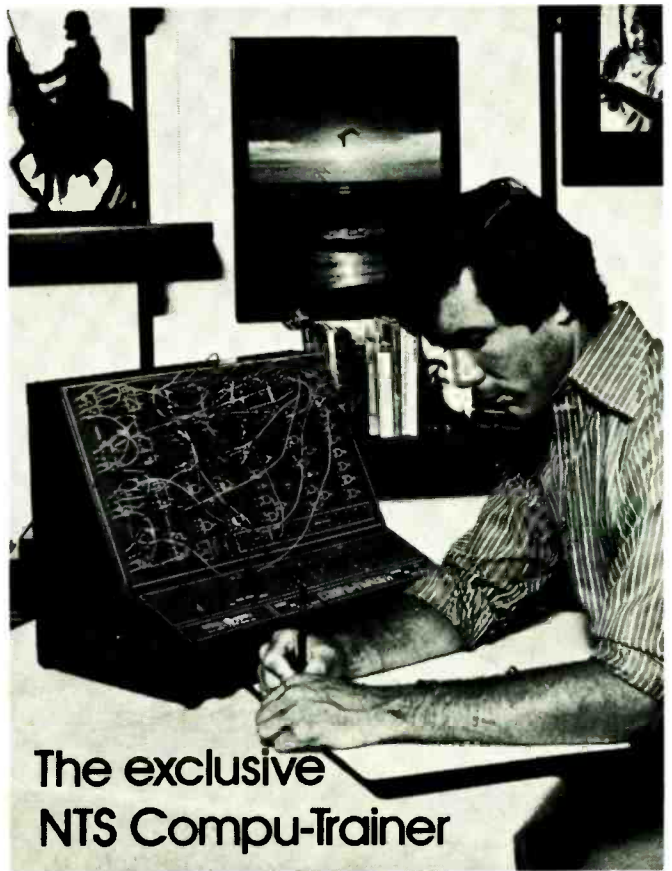

The exclusive
NTS Compu-Trainer

NTS COMPUTER ELECTRONICS

Build and operate the exclusive NTS Compu-Trainer! Loaded with integrated circuits, it teaches you the how, what, and why of computers faster, more thoroughly. You perform all wiring and patch-cording. No short-cuts. No pre-wired circuit boards. Also receive an FET Volt-Ohmmeter and a 5" wide-band Oscilloscope.

NTS ELECTRONIC COMMUNICATIONS

Gain the prestige and earning power of owning an FCC First Class Radio Telephone License! Two exciting courses in the fields of transmitting and receiving. Experiment with an amateur phone 6-meter VHF transmitter, NTS' exclusive 6-transistor solid-state radio, and a fully transistorized volt-ohmmeter.

5-watt AM
transmitter/
receiver.



NTS AUTOMATION/ INDUSTRIAL ELECTRONICS

Systems automation is the future of industry — and you can play an important role! Enter the age of electronic controls by training on the NTS Electro-Lab — a complete workshop. Also receive a 5" wide-band professionally rated Oscilloscope. Build five industrial controls to regulate motor speed, temperatures, pressure, liquid level and much more.

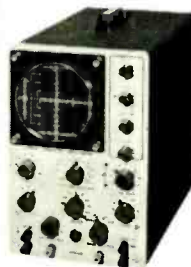

5" Oscilloscope

CLASSROOM TRAINING AT LOS ANGELES

You can take classroom training at Los Angeles in sunny Southern California. NTS occupies a city block with over a million dollars in facilities devoted exclusively to technical training. Check box in coupon.

APPROVED FOR VETERANS

Accredited Member: National Association of Trade and Technical Schools; National Home Study Council.

NATIONAL TECHNICAL SCHOOLS

WORLD-WIDE TRAINING SINCE 1905
4000 S. Figueroa St., Los Angeles, CA 90037

Please rush Free Color Catalog and Sample Lesson, plus information on course checked below. No obligation. No salesman will call.



National Technical Schools

4000 S. Figueroa St., Los Angeles, CA 90037

- Master Course in Color TV Servicing
- Color TV Servicing (For Advanced Technicians)
- Master Course in B&W TV & Radio Servicing
- Master Course in Electronic Communications
- Practical Radio Servicing
- FCC License Course
- Master Course in Electronics Technology
- Automation & Industrial Electronics
- Computer Electronics
- Basic Electronics
- Stereo, Hi-Fi & Sound Systems
- High School at Home

Dept. 206-012

Name _____ Age _____

Address _____

City _____ State _____ Zip _____

- Check if interested in Veteran Training under new G.I. bill.
- Check if interested ONLY in Classroom Training at Los Angeles.

Stop Expensive Tune-Ups!

With This Easy-to-Build, Universal Auto Analyzer Kit



Almost Pays for Itself the First Time You Use It! For ANY Car!



Step-by-Step Assembly Instructions—Fun to Build!

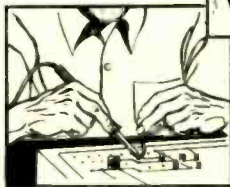

Cut car costs—be your own "mechanic" with our low-cost electronic troubleshooter. Check out electrical and ignition systems, set idle speed and timing, test plugs and points, more. Built-in tachometer, dwell meter, ammeter, ohmmeter, voltmeter, leakage tester—read all tests on the big 7½" meter. Solid-state circuitry, battery powered for use anywhere. With illustrated assembly instructions, operating manual, 48-page "Tune-Up Guide," 4 "C" cells—everything! 1000's in use. At Radio Shack and Allied Radio stores everywhere or postpaid. **49.95** with this ad

Over 1300 Stores Nationwide
See Your Phone Book

RADIO SHACK

AND ALLIED RADIO STORES
A TANDY CORPORATION COMPANY

Dept. RE-15

2725 W. 7th Street, Fort Worth, Texas 76107

Rush me _____ Auto Analyzer(s) at 49.95 ea.

postpaid plus applicable sales taxes. Check or money order for \$_____ enclosed.

Please PRINT Clearly

Name _____ Apt. # _____

Street _____

City _____ State _____ Zip _____

Circle 13 on reader service card

equipment report

Ten-Tec RX-10 Communications Receiver



Circle 56 on reader service card

I'VE BEEN INTERESTED IN THE SYNCHRODYNE, homodyne and other types of direct-conversion receivers for quite a few years. So, when I saw ads on the Ten-Tec model RX-10 communications receiver, I knew this was one set that I wanted to try. What's the appeal of this receiver? To some, its low cost (around \$60.00), weight (about 2 pounds) and its drain of only 35 mA from a 12-volt battery may be its major attractions. However, I was immediately intrigued because the RX-10 is advertised as using a synchrodyne circuit.

When the receiver arrived, I

couldn't wait to try it. It does not have an audio power amplifier, its output is designed for headphones with an impedance greater than 1000 ohms. I knew that I had lots of headsets around and did not anticipate any problem. Well, somewhere along the line, I'd given my 2000-ohm headsets to kids for use with code oscillators and simple home-built receivers etc. and the only phones I had worked at voice-coil impedances. Local radio parts stores did not have high-impedance phones in stock or only had high-quality types costing more than I cared to spend.

Then, a mind-blocking near-panic set in and for nearly a week I wondered how I could test the RX-10. After my 11-year-old son asked why I couldn't play it through his record player, the fog cleared and my mind was literally flooded with alternatives to the headphone dilemma. My solution was to use a small audio output transformer to match the receiver to 8-ohm phones.

The RX-10 tunes the 3.5-4.0, 7.0-7.3, 14.0-14.6 and 21.0-21.9-MHz ham bands. I tied on a long-wire antenna and fired 'er up. All I could hear was high-speed code and radioteletype

(continued on page 84)

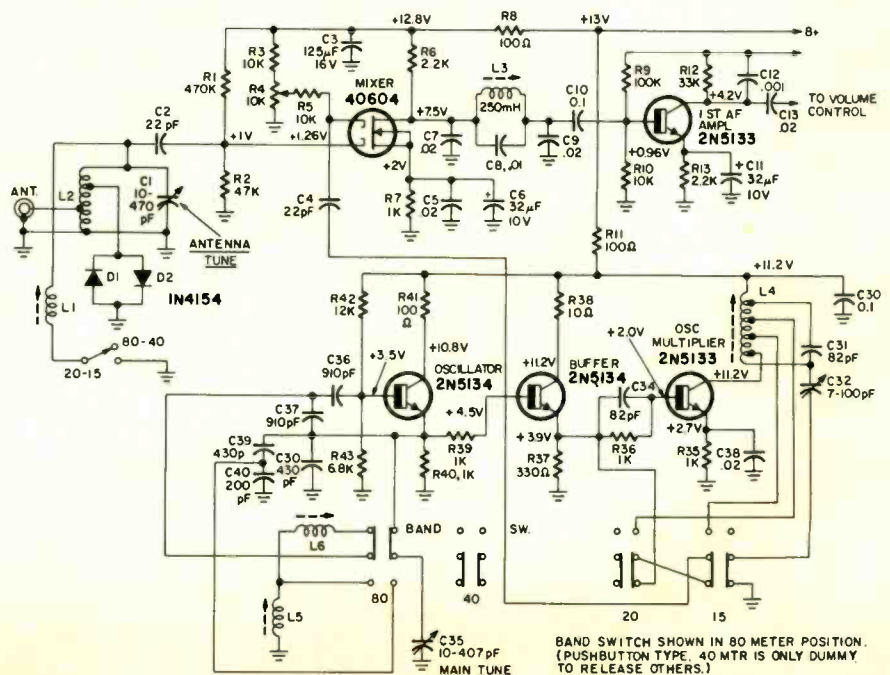

BAND SWITCH SHOWN IN 80 METER POSITION. (PUSHBUTTON TYPE, 40 MTR IS ONLY DUMMY TO RELEASE OTHERS.)

You can now buy liquid crystal displays off the shelf as well as get the chemicals and parts for them separately. These devices have micropower supply requirements, extreme thinness, high brightness, and a bunch of other advantages. Here's how they work, what's available, how they stack up to led's, what you can do with them, and where to get materials for your own displays.

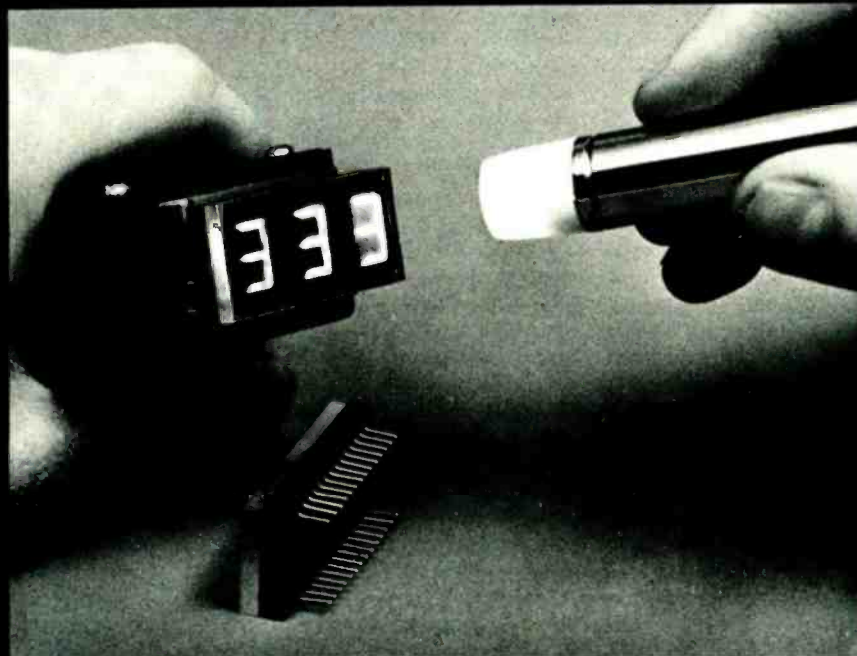

LIQUID CRYSTAL DISPLAYS

by DON LANCASTER

A LIQUID CRYSTAL IS A CHEMICAL THAT FLOWS LIKE A LIQUID, yet retains an orderly molecular structure within that flow. Many chemicals behave this way over a limited temperature range. Some of these also have unique electrical or thermal properties that make them attractive for a wide variety of electronic uses. For instance, *cholesteric* liquid crystals have a very interesting property—they change color wildly for a very small temperature change. These have been available for several years and are used widely for thermal and heat studies, microwave power field analysis, medical diagnosis, and even in dime-store novelties.

A more recent development is the *nematic* liquid crystal, whose properties were first described extensively by RCA engineers in 1968. Nematic crystals are clear, but whenever you apply an electric field, they turn milky or cloudy. Chemically, the process is called *dynamical scattering* and the cloudiness or milkiness is caused by the external field interacting with the ordered liquid structure.

An obvious use for something that turns white whenever you apply voltage is an electronic display. To make things more interesting, liquid crystals are also poor conductors, which means they draw practically no current when they're in the milky state and zero current when clear. This makes liquid crystals particularly attractive for watches, clocks, miniature computers, and pocket calculators. We can also use them as *Nixie* tube replacements on electronic instruments, particularly on battery-powered versions. Liquid crystals offer quite a bit as a possible route to flat-screen TV displays. The computer people are also interested, because certain combinations of nematic and cholesteric liquid crystals can also exhibit *storage* and *memory*, important features in a terminal or computer output display where the information need only be provided once by the computer instead of having to be refreshed 60 times a second as in ordinary TV.

Liquid crystal displays do not *generate* light. They either *reflect* it or *transmit* it, depending on how you use

them. This means that there is no contrast problem with high ambient light levels—the brighter the room lights, the brighter the display. Normally the liquid crystal material is only a mil or two thick, making for an extremely thin display. It can be made into a display of any size, and we could even imagine room partitions or windows using liquid crystals for controllable privacy or light transmission. And, you can make liquid crystals into any color display you want—white for maximum contrast, red to alert or warn, yellow or green for easy reading, blue for attractive appearance.

Right now, you can't go out and buy liquid crystal displays for 50¢ a digit, but the potential is certainly there. Several manufacturers now offer composite displays and individual digits. These are still rather expensive in small quantities, although their quantity (1000-10,000) prices are competitive with Nixie and Light Emitting Diode (LED) displays, particularly if large digits or alphanumeric are needed.

Materials

One of the first nematic materials studied by RCA is an organic jaw-breaker going by the name of Anilydene-Para-Aminophenylacetate. A half-mil (0.0005-inch) thick layer of this

chemical you'll be able to mix up in your kitchen sink, the stuff is readily available and ranges in price from \$4 per gram in 5-gram lots to under \$1 per gram in kilogram lots. Depending on the character size, a gram is enough for a hundred or so characters or digits. Thus the price per digit is around 4¢ each. Other nematics are similarly priced, ranging up to \$15 per gram in small lots.

Fig. 1 shows four popular liquid crystal configurations. In Fig. 1-a, we have a simple *transmissive* display. Here the liquid crystal is sandwiched between two layers of conductive glass or any suitable transparent, rigid material with a conductive path on its *inside* surfaces. With a modern liquid crystal compound, 12 to 15 volts is needed to block light transmission through the display, while 0 volts allows light to pass through freely. Thus, this type of display is directly compatible with MOS or COSMOS integrated circuits, but will not give acceptable contrast when driven with 5-volt TTL (at least not with presently available materials). Fig. 1-b shows a *reflective* display, where the back conductor becomes a reflector that returns scattered light to the observer. This is the most popular form, because only external room lighting is needed to view the display.

To improve the contrast and to get by on lower operating voltages, we can use other optical properties of liquid crystals, as shown in the *bi-level* displays of Figs. 1-c and 1-d. Some liquid crystals have an optical property called *birefringence*. *If the birefringence is voltage-controllable, we can use it to selectively rotate polarized light. In 1-c we have two light polarizers that are parallel in orientation. With no voltage applied, the liquid crystal does not significantly affect the plane of polarization of the light. The first polarizer polarizes the light and the second one passes it freely. This is called a normally open display. When voltage is applied, the liquid crystal rotates the plane of polarization 90° and the second polarizer blocks the light transmission. To get the normally closed display of Fig. 1-d, we use crossed polarizers. Here, in the absence of a voltage, the first polarizer polarizes the light, the liquid crystal does nothing to it, and the second one blocks the transmission. Fancier forms of bilevel displays can be used in the reflective mode and some can even produce selectable colors.*

Some problems

Liquid crystals still have some problems and disadvantages. The cell holding the liquid must be dimensionally stable, clear, and a conductor,

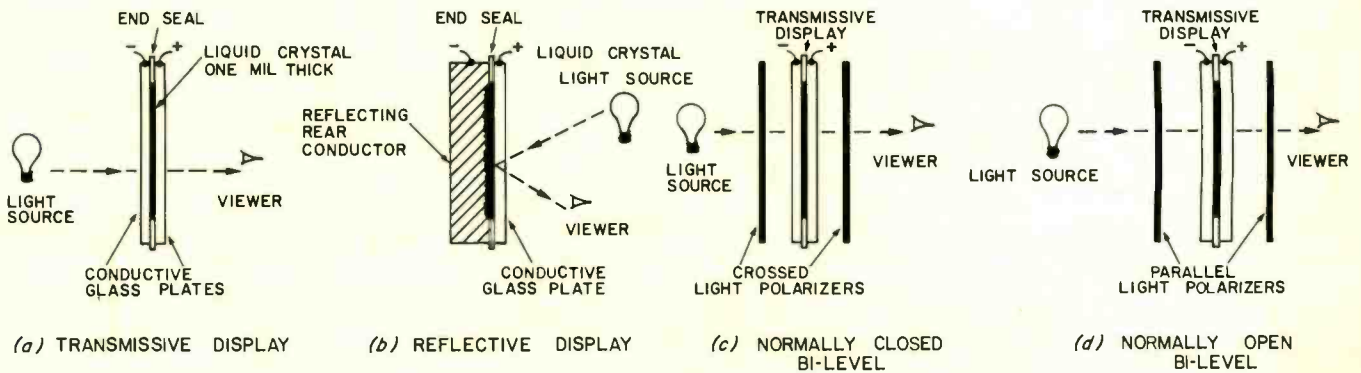

was placed between two pieces of conductive, transparent glass and heated to its nematic operating range of 83° to 100° C. When 60 volts was applied, (an equivalent *field strength* of 120,000 volts per inch), the test cell turned milky, blocking transmitted light and reflecting incident light. With no voltage applied, the cell was clear. The best brightness of this early display was around half that of a good piece of writing paper.

Things have improved considerably since those early tests. Research by such people as RCA, Kent State University, Penn State University, Vari-Light Corp., Optel, Ilixco, and Liquid Crystal Industries has made a wide variety of room temperature operating liquid crystals available. One of these is p-Methoxy-Benzylidene, p-n-Butyl-Aniline 4-Methoxy, 4'n-Butyl-Benzylidene-Aniline. While this isn't the sort of

FIG. 1—FOUR COMMON CRYSTAL displays, showing transmissive and reflective effects.

FIG. 2—DECIMAL COUNTERS using liquid crystal devices. 2-a, working with dc, uses a single IC; the ac version in Fig. 2-b has a longer display life but is more complex.

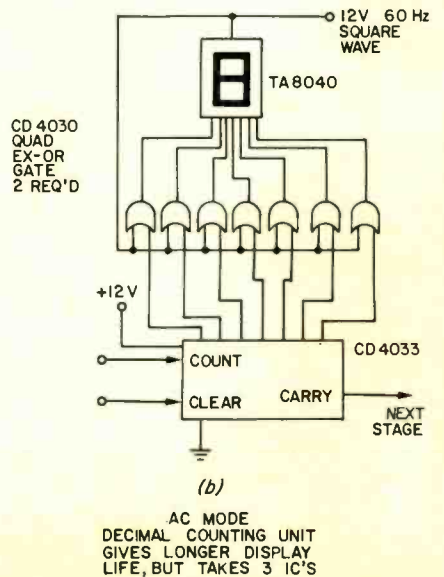
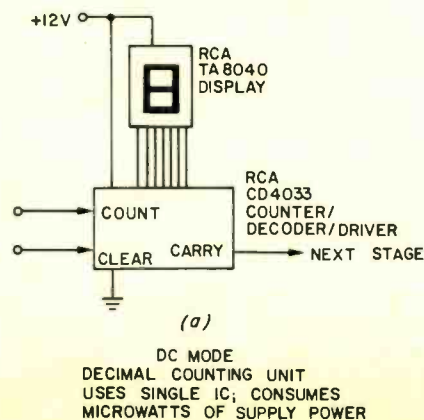

at least on its inner surfaces. There is presently no ultra-low-cost material that fits these standards, and you have to go to a fairly fancy coated glass to meet the requirements. One widely used glass is the *Nesatron N-2* manufactured by *Pittsburgh Plate Glass Industries*. The process puts a metallic oxide on the glass surface and does it at low temperatures, preventing any stress or annealing effects from hurting the flatness of the glass. Coated glass of this type runs around \$14 per square foot, dropping to \$10 per square foot in quantity. This is seven to ten cents a square inch, so it turns out that the glass you look through costs twice as much as the liquid crystal material itself. The *Vari-Light* people offer a 2 x 2½-inch piece of electrically conductive glass with a busbar edge for \$1.50 each in single quantities. This should be enough for either one transmissive four-digit display or two reflecting ones.

The liquid crystals are sensitive to impurities, so reliable displays must be hermetically sealed. Bubbles must obviously be avoided—they will degrade the display appearance. Capillary and edge effects present a problem with any thin liquid film. Obviously the display must not leak. Small impurities can alter the dynamic scattering drastically, and mechanical stress on the conductive

source if long lifetimes are needed. Fig. 2a shows how we might build a decimal counting unit by connecting a MOS decimal counter-decoder to a 7-segment liquid crystal display. Note that we only need two parts for the complete count-decode-display operation. We can run this on *ten microwatts* at a 1 Hz counting rate for the counter, and around *20 microwatts* or so for the display on the average.

The trick is to run the IC's on dc, yet convince the display it is running on ac, without going to any fancy Triac drivers or anything like that. To get long life ac operation, we use the circuit of Fig. 2-b. Here seven EXCLUSIVE OR gates are added between the counter and the display, which is driven off a 60-Hz square wave. The exclusive OR gate turns the square wave upside down (inverts it) whenever you want to light a segment, and simply passes it on whenever you want the segment off. An *off* segment sees the same signal on both ends and doesn't light. An *on* segment sees 15 volts across it all the time, alternating polarity 120 times a second. Thus we get ac display operation with dc on the integrated circuits at reasonable cost and complexity.

Liquid crystal displays are somewhat slow. Normally they turn on in 10 milliseconds or so and off in 100 to 200

turnoff is needed. They *can* be used at television vertical rates, and TV displays using liquid crystals have been demonstrated. Considerable effort will be needed before a flat screen liquid crystal TV or computer display becomes a commercial reality.

A final problem with liquid crystals is that LC displays do not *multiplex* very well. Multiplexing is a trick you use to share one decoder-driver with many digits, thus holding down system costs and the number of interconnections. For instance an eight-digit display done normally would take 57 connections and eight decoder-drivers. If we multiplex, we get by with one decoder-driver, one eight-point scanner, and 15 connections, assuming you're using 7-bar displays. To multiplex, you run each digit at eight times normal brightness for one-eighth of the time, and switch them fast enough that the human eye can't follow. The eye sees a continuously lit display of normal brightness. The breakeven point on multiplexing is four digits; the more digits, the more you gain.

Neon lamps, *Nixie* tubes and light emitting diodes multiplex very well since they can be overdriven for short times, and more important, since they are inherently diodes that block current in the reverse direction or below a threshold value. Liquid crystals cannot reflect more light than they receive, and they do not have a well defined off-on threshold. Thus, at the very least, series diodes are needed for each segment of each digit to prevent sneak paths and ghost images. Good multiplexing techniques will eventually develop, but right now liquid crystals are not overly attractive for multiplex use.

Liquid crystals versus LED's

The light emitting diode, or LED, is rapidly becoming the dominant type of readout used today, replacing the now obsolete *Nixie* type with its high voltage requirements. LED's combine a long life, very attractive appearance, TTL 5-volt compatibility with a wide availability, and, recently, low cost. How do they stack up against liquid crystals?

The obvious answer is that both LEDs and liquid crystals have unique advantages and they can each serve an important segment of the display market. Where you want to *produce* light, you must go the LED route. For good multiplexing, high-speed operation, complex alphanumeric, and custom arrays, LED's are the way to go. They also have very much of a head start in the marketplace and right now are more attractive than the liquid crystal displays in appearance.

On the other hand, it always takes more power to produce light than to guide it, and liquid crystal technology is inherently simpler than semiconductor



REFLECTION FROM A MIRRORED SURFACE is minimized with nematic liquid crystals. Future applications may include an automatic dimming rear-view car mirror.

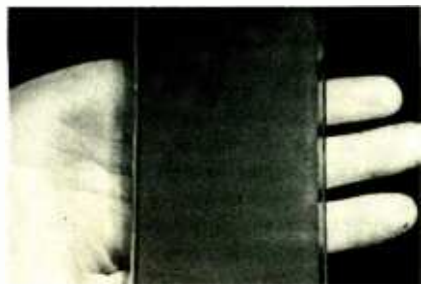

CONTROLLING THE TRANSMISSION OF OBJECTS opposite a viewing surface using nematic liquid crystals, makes display overlays, optical shutters and automatic dimming windows possible.

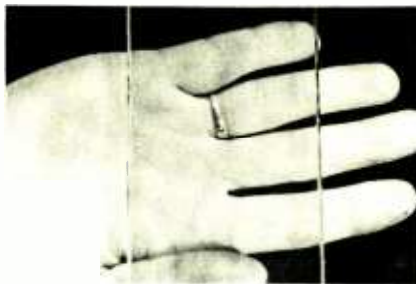

glass faces can alter the optical birefringence properties dramatically.

If you apply a dc voltage continuously to a liquid crystal, it loses contrast after a 2000 to 10,000-hour operating lifetime. To get around this, the displays should be run from an ac

milliseconds. While we can speed them up a bit with "quenching" techniques, they are inherently slow devices. They're great for people, but cannot generally be used in such high-speed applications as electronic shutters, film annotation, and anywhere else a fast

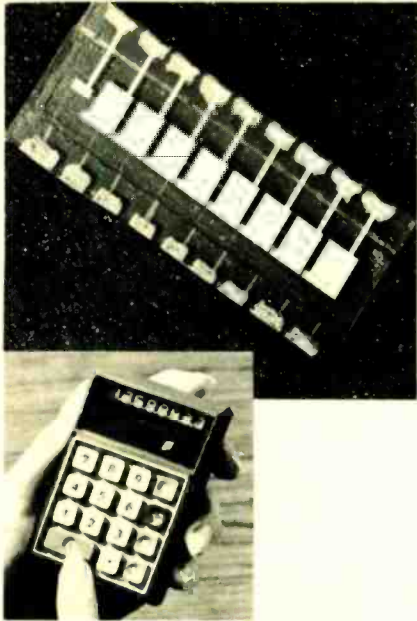

EIGHT DIGIT liquid-crystal display (larger photograph) forms the readout of a new pocket size electronic calculator made by Ragen. The calculator will retail for about \$100.

technology. So for lots of digits, low power, low cost, the liquid crystals are very much the better choice. We could envision eventually some gel form of liquid crystal that is silk-screened onto displays by the mile at a cost of pennies per digit. Important first applications of liquid crystals will be in pocket calculators and electronic clocks, particularly miniature, battery-powered ones. Liquid crystals generally interface with high density MOS integrated circuits without needing any high current driver stages. It doesn't take too much imagination to see a pocket add-subtract-multiply-divide-store calculator that's nothing but a keyboard, a single LSI chip and a display combined with a battery. You end up with a device that's far less complex and far simpler to manufacture than a \$2.50 AM transistor radio.

What's available now?

Table I lists the manufacturers of liquid crystal displays. Commercially available units are offered by RCA, OPTEL, and ILIXCO.

RCA initially offers six units. Two are single-numeral 0.75-inch high versions that plug into a PC connector. The TA8032 is a transmissive style while the TA8034 is reflective. Total display power is 35 microwatts at a supply voltage of 12 to 15 volts. The operating temperature range is 5° to 55° Centigrade. (22° C is "room" temperature). Introductory single quantity price is \$25, dropping to prices competitive with LED displays in quantity. Since, as we'll see below, the ILIXCO prices in single quantities run \$8 per digit, we can expect these introductory prices to drop to

TABLE I LIQUID CRYSTAL DISPLAYS OFF-THE-SHELF SUPPLIERS

ILIXCO
Box 184
Kent, Ohio, 44240

OPTEL CORPORATION
Box 2215
Princeton, N.J., 08540

RCA SOLID STATE
Central and Terminal Avenues
Clark, New Jersey, 07066

TABLE II MATERIALS FOR BUILD-YOUR-OWN LIQUID CRYSTAL DISPLAYS

CHEMICALS

Liquid Crystal Industries
460 Brown Avenue
Turtle Creek, Penna., 15145

Vari-Light Corporation
9770 Conklin Road
Cincinnati, Ohio, 45242

CONDUCTIVE GLASS

P.P.G. Industries
New Products Development
One Gateway Center
Pittsburgh, Penna., 15222

Vari-Light Corporation
9770 Conklin Road
Cincinnati, Ohio, 45242

POLARIZERS, OPTICS, MISC.

Edmund Scientific Corp
101 East Gloucester Pike
Barrington, New Jersey, 08007

reasonable levels very shortly, perhaps by the time this is in print.

The other four RCA units are four-digit ones, two with decimal points for instrument use and two with colons in the middle for clock use. One of each type is reflective and one is transmissive. This is their TA8040-43 series. These are initially offered at \$75 each, dropping in quantity to competitive prices with LEDs. The characters are 0.6-inch high and the unit plugs into a conventional PC socket. Total power for four digits is around a milliwatt with all segments energized on 15 volts.

OPTEL has two units, a three-digit 1003 and a 3½-digit model 1053. The 1003 comes with decimal points, while the 1053 has a colon and is intended for clock use. The characters are 0.450 inches high and the power dissipation is 40 microwatts per segment at 20 volts. The operating temperature range is 0 to 50° C. and, as with the others, prices are competitive with LED devices in quantity.

ILIXCO presently offers the lowest prices and widest variety in stock displays. They have ten displays available, ranging from 3½ digits to 8 digits and in both 0.4-inch and 0.8-inch sizes. The 3½-digit versions are offered for clocks, while the intermediate sizes are suitable for digital instruments, and the 8-digit version is intended for pocket calculator use. The prices range from \$8 per digit in single quantity down to \$5 per digit in 50 lots. The ILIXCO units are bilevel and operate clear down to 5 volts, although operation is best between 7 and 15 volts. Their display appears as a dark blue character on a clear background.

Other stock liquid crystal displays

should soon be available from a wide range of manufacturers and it is reasonable to expect the per-digit prices to drop dramatically once serious competition and production economies set in.

Building your own

With commercial units still somewhat expensive for an experimenter's budget, you might like to try building your own liquid crystal display. Sources of materials are listed in Table II. This should be a hot science fair, school, or university project as it is a rather exotic technology that you can still work with yourself on a lab bench or a kitchen table and still come up with a working device.

Probably for openers, 5 grams of *Vari-Light* VL462N at \$12.80 and a CG-75 gold coated glass at \$1.50 might be a good starting point. You can use one or two mil drafting Mylar (25¢ a sheet at any drafting or photocopy store) for spacing, and might try first building up a simple transmissive system that turns cloudy whenever you apply 15 or 20 volts. You could then try printing an invisible message on the glass with PC photoresist and turning the message on and off with the control voltage. From that point on you should be able to work up your own 7-segment readout, eventually ending up with a leakproof, bubble-free version you can stand on end. There are all sorts of possibilities.

Liquid crystals aren't particularly toxic, but their long-term effects aren't really known and some of them do penetrate the human skin very easily. SO,—

(continued on page 90)

ately left anonymous until tests were finished. In all cases, the method worked. The checks showed the transistors to be the type we knew they were.

Test equipment needed

You will need a minimum of one piece of test equipment—a good ohmmeter! Any good in-circuit/out-of-circuit transistor tester makes it easier and a signal generator/scope enables quick checks to get into the area of the trouble as fast as possible. (There is, of course, only one *infallible* test for any transistor; **Does it work?** If you find the right signal in and the right signal out, forget it; this one is working).

Our biggest problem is identifying unknown transistors. We need to know five things about a transistor: npn? pnp? germanium? silicon? base connections?

With the tests described in this article you can get this information. Of course, it does help to know if the transistor is good or bad, but this is simple. You'll find unmistakable reactions during the tests that will tell you.

Three diodes

The basic test used here is the familiar *three-diode method* (see Fig. 1). Checking between each pair of leads of a transistor with an ohmmeter, you should get a high reading one way, then a much lower reading by reversing the ohmmeter prods; just as if you were checking a diode. This is very obvious, out-of-circuit, and shows up fairly well incircuit, unless there is a very low resistance shunted across the transistor. Even then, you'll usually see enough to help. If you are left in doubt, take the transistor out for a definite out-of-circuit check.

The indicated resistance depends on several things; the material of the junction; the voltage applied by the ohmmeter battery, plus the polarity of the voltage applied! (By the way, despite the many warnings, I have never yet damaged a transistor with an ohmmeter. There is apparently enough series resistance in the circuit to hold the current to safe values.)

The "Necessities"

The first step is to determine the polarity of the voltage at your ohmmeter prods. This is the one key point we use in all of the tests to come. We'll mention polarity, and you'll see polarity markings in the diagrams. This means the polarity of the voltage applied by your ohmmeter. Remember that! You can get this by checking the schematic; faster still, just sit the thing on OHMS and read the dc voltage with another meter.

In all the transistorized meters I've seen (TVM and FETVM), the red prod is *POSITIVE*. In the VTVM's, it seems to be *NEGATIVE*. In a lot of VOM's, it will

also be negative. (Incidentally, since electronics men are trained to think Red = Positive, if your ohmmeter has a "red negative", just reverse the ohmmeter prods in the jacks, so that red is positive. Believe me, it'll be easier that way, and I won't tell you how I found out.)

Two sets of test leads make it much easier; a set of needle-point prods for in-circuit tests, and another with clips for out-of-circuit test. Use the small clips, with a tight grip; those teeny leads are hard to get a grip on!

Verification

Because of the normal wide variation in transistors, junctions, ohmmeters, and so on, you will **not** get exactly the same readings I did. So, do this: make the same tests yourself, using your own test equipment. Get four new transistors out of stock. One each pnp and npn germanium, and the same in silicon. Now, verify my results! Repeat the tests until you are familiar with the readings for each type, and the connections.

I used three ohmmeters for my tests: a tvm, a vtvm and a vom. Most of the time, I used the R x 100 range. Un-

less otherwise specified, this is the range I mean. For most checks, use a range that will give you a "low" reading somewhere between center scale and the low part (zero).

The actual reading in ohms is not too important. What is important is the *ratio* between the two, one high and the other low. We'll use the actual (indicated) reading in one test, but once

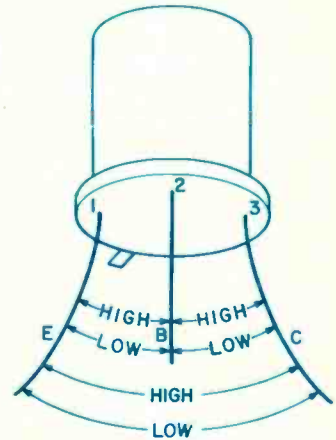

FIG. 1—HIGH-LOW READINGS between each pair of leads, by reversing the prods. This is the "diode-effect".

<p>NPN GERMANIUM</p> <p>RESISTANCE: HIGH SHORT BASE TO: E - R GOES DOWN C - R INCREASES SLIGHTLY</p>	<p>NPN GERMANIUM</p> <p>RESISTANCE: LOW SHORT BASE TO: E - R GOES UP C - R GOES DOWN</p>	<p>TRANSISTOR: RCA SK-3010</p>
<p>PNP GERMANIUM</p> <p>RESISTANCE: LOW SHORT BASE TO: E - R GOES UP C - R GOES DOWN</p>	<p>PNP GERMANIUM</p> <p>RESISTANCE: HIGH SHORT BASE TO: E - R GOES DOWN C - R GOES UP SLIGHTLY</p>	<p>TRANSISTOR: RCA SK-3003</p> <p>VTVM: HICKOK 209 TVM: SENCORE FE-14 VOM: TRIPLETT 625NA</p>
<p>NPN; SILICON</p> <p>RESISTANCE: INFINITY SHORT BASE TO: E - R GOES DOWN C - NO CHANGE</p>	<p>NPN SILICON</p> <p>RESISTANCE: INFINITY SHORT BASE TO: E - NO CHANGE C - R GOES DOWN</p>	<p>TRANSISTOR: RCA SK-3024</p>
<p>PNP; SILICON</p> <p>RESISTANCE: INFINITY SHORT BASE TO: E - NO CHANGE C - R GOES DOWN</p>	<p>PNP; SILICON</p> <p>RESISTANCE: INFINITY SHORT BASE TO: E - R GOES DOWN C - NO CHANGE</p>	<p>TRANSISTOR: RCA SK-3025</p> <p>METERS: SAME AS BEFORE</p>

FIG. 2—OHMMETER TESTS for identifying transistors, out of circuit. Exact resistance readings will vary, but ratios won't. Note effects of shorting base lead to other two, in different types.

more the ratio and not the actual value will be the key clue.

The "High-Low" test method

Start with the clip-leads in the ohmmeter, since it will be easier to begin with the out-of-circuit tests. Pick out any one of your test transistors. Get a piece of scratch paper and make a rough sketch of the basing, showing only the three leads. It may help you keep straightened out (it does for me!)

1. Check for the diode-effect, on all three leads, reversing the prods to make two measurements on each pair. Never mind which leads; this, and the basing, is one of the things we want to find out. If you see the diode-effect, high resistance one way, low with prods reversed, ok. This indicates a good transistor.

2. By trial and error find out which lead has about the same resistance, to the other two. This resistance may not be exactly the same, but it will be the closest match. Now you've got something. The lead that shows the same low resistance to the other two is the base. Mark it. (That's one!)

3. Now we know the polarity of this transistor. If the negative ohmmeter lead is on the base, it's a pnp. If the positive lead is on the base, npn. (That's two!)

4. Move the clips to the other two leads. Find out which way they show the low resistance. The positive lead will be on the emitter of a pnp; on the collector of an npn. (That's three and four, and we've identified all leads, and the

basing!)

(Up to this point, we haven't had to check the actual value of the indicated resistance. All we've needed is high or low. Having determined the polarity and basing of this transistor, we want to know whether it's germanium or silicon.)

5. Check the reading in the low direction, from collector to emitter. If this is down to a few hundred ohms (200 to 600 ohms was about where they ran for me, on the R x 100 range), and reversing the prods shows about 8 times that, but still a readable deflection, you have a germanium transistor.

If the low resistance is much greater, say around 3000 to 4000 ohms, and the high reading is infinity (no reading at all) the unit under test is a silicon transistor. (Remember to check this with your own ohmmeter!) In small silicon transistors, you will probably get a reading between collector and emitter. In the high-voltage silicon power transistors, you may get infinity in both directions! In some of these, turning up to the R x 1-megohm range may show a "low" reading. This tells you that the collector-emitter junction is not open. Some of the high-voltage silicon, such as HEP-740 (700 volts BV_{ceo}) will not show a reading even on the R x 1-megohm range. (Another test for this coming up!)

Fig. 2 is a chart of the test readings I got on my sample transistors. These tests repeated on quite a few different transistors of all sizes, ratings and makes. So I believe they will be helpful. You might cut this out and paste it on the wall! Polarities shown, I repeat, are those of the ohmmeter! Note the differences between germanium and silicon transistors.

Here is the test I mentioned, for the collector-emitter junction. With the ohmmeter hooked up as shown, note the reaction when you short the base to the other two leads. For example, with the npn and a negative collector, shorting the base to the emitter makes the indicated resistance drop way down. Reversing the polarity of the ohmmeter, and shorting the base to the collector, the resistance drops. I believe that this can be used as an indication of a good collector-emitter junction.

The hard part

Now we come to the hard part. Identifying unknown transistors in-circuit. Outside of actual performance, in-circuit testing of transistors is always an "iffy" thing. (In other words, "If it works, it's good!") So far, my experience has been that if an in-circuit transistor tester says that it's good, it is. If it says it's bad, it may or may not be. In any case, if you get a bad reading in-circuit, you're going to have to take it out anyway. Repeat the tests; out-of-cir-

cuit tests are accurate.

There is one thing which can never be checked in-circuit; leakage. There are always so many shunt paths around a transistor circuit that this test is meaningless. Out-of-circuit tests will show you whether it has leakage or not. One good clue to leakage problems is the "Things are almost all right but it doesn't work too well!" symptom. This is where the transistor-tester comes in. It will show you the actual leakage. (Incidentally, all germanium transistors have some leakage. Power types can have up to 200 to 300 μA and still work. Silicons, on the other hand, should normally show zero leakage! even 10 to 20 μA is too much, in power types!) The ohmmeter will not read transistor leakage! Don't bother.

However, the ohmmeter does a good job of finding common faults, in-circuit. Shorted transistors will give you the same reading both ways across a junction, usually zero ohms. An open junction will show up by giving you the same reading both ways, usually that of the shunt resistance. Fig. 3 shows a couple of examples. If you read 3300 ohms both ways across the base-collector junction in 3-a, it is probably open. In 3-b, if you read a dead short across the collector-emitter junction, both ways, it's probably shorted. For a definite check, pull the transistor and repeat.

The worst case tests

This test is often used by engineers. In our business, the worst possible case would be one of those sets with nothing but a batch of solder-blobs. No identification, no lettering, no nothing.

Locate the transistor on the parts-side of the board. Shine a light through the board, and locate the transistor terminals, as in Fig. 4-a. This can be sketched as shown; helps to remember! At first, all we know is that there are three blobs. Number them. Now, put the needle-point prods in the ohmmeter, and away we go.

First checks show a low reading of about the same value between 2 and 1, also 2 and 3. So, we say that 2 is the base (Fig. 4-b). The positive prod is on 2. So, this is an npn. Moving the prods to 1 and 3, we find the low-reading direction. The positive prod is on 3, so this is the collector. By a process of elimination simple enough even for me, 1 is the emitter.

Using the in-circuit transistor tester confirms this. In the LEAKAGE position, we see a full-scale reading set to pnp, and a much lower reading on npn. (We are not using the leakage tester as such; just for a double check on the polarity of the transistor.) However, the tester will not show a beta reading. So pull the transistor, repeat the test, and the tran-

(continued on page 90)

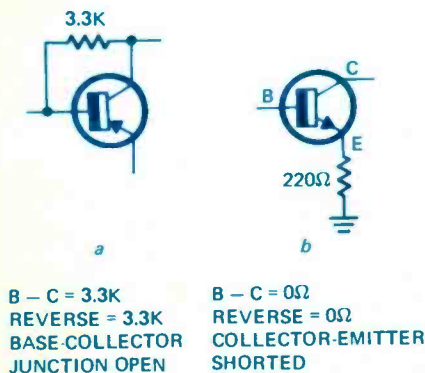

FIG. 3—POSSIBLE IN-CIRCUIT ohmmeter reactions, to different faults.

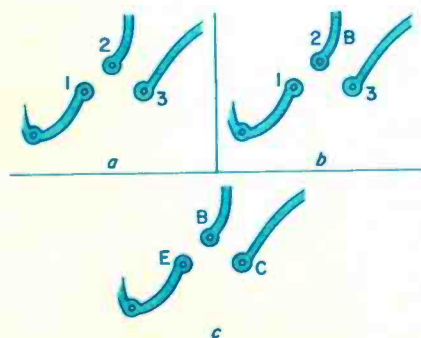
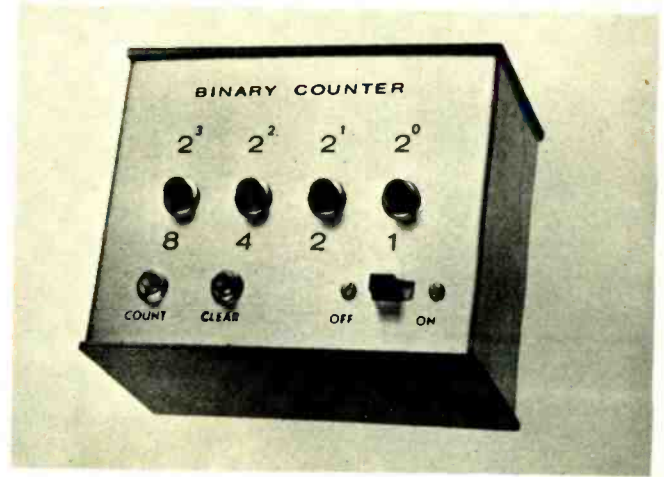
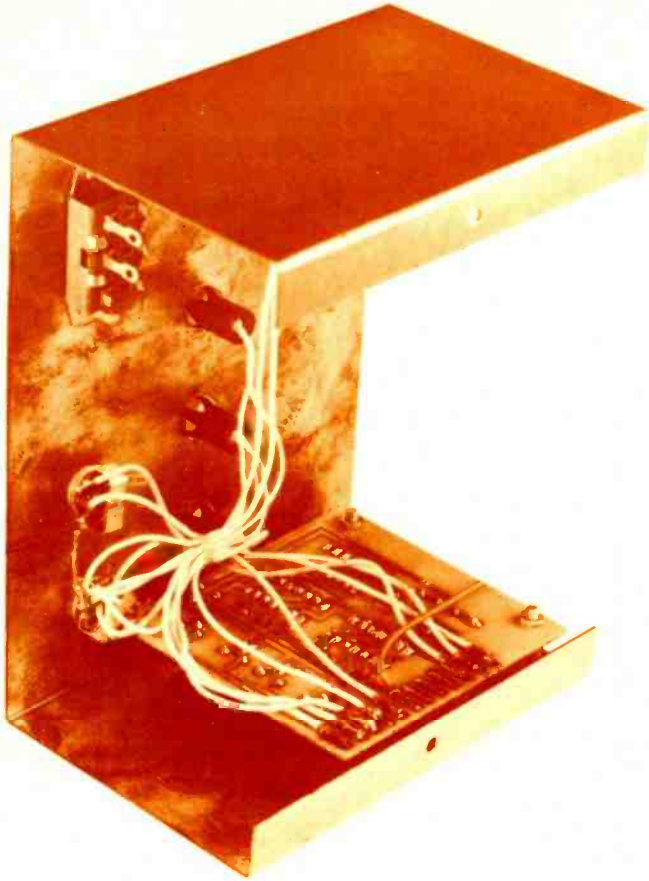

FIG. 4—FINDING THE BASING, type and location of transistor, in unknown set. One step at a time. Sketch helps.



Experiment with a Binary Counting Demonstrator

It's easy to understand counting to the base two when you have a visual aid like this demonstrator to show you what's going on.

by FRANK GROSS

This binary counter demonstrator counts by two's instead of tens, showing the base two arithmetic and counting used by most computers. It counts up to sixteen and can be reset to zero at any time. You use it as a study or teaching aide, or as a science-fair or computer-technology entry, or for a school lab project. It uses three TTL integrated circuits and four transistors and may be built in an evening or two.

Why binary?

People are used to counting by tens, and before "modern math" came along, non-computer people gave very little thought to counting in any number base but ten. The problem with *decimal* or *base ten* counting is that you need ten

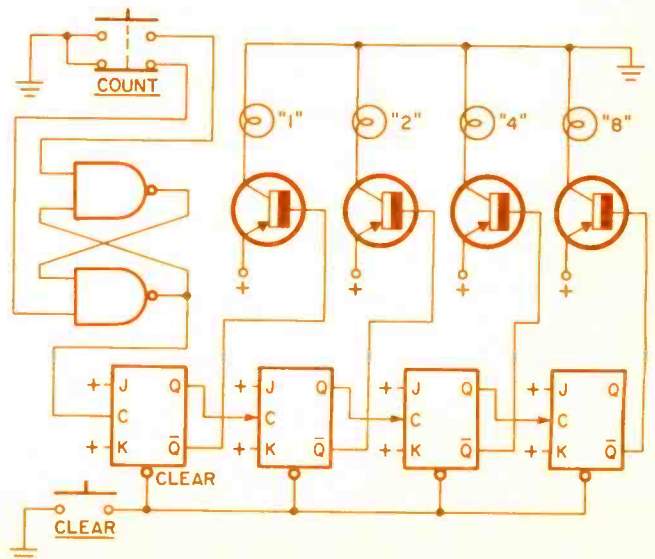

FIG. 1—BASIC LOGIC DIAGRAM of binary ripple counter

PARTS LIST

- C1—47 μ F, 15 volts, electrolytic
- C2—0.1 μ F, 10 volts, disc ceramic
- *C3—0.05 μ F, mylar or disc ceramic
- *C4—2500 μ F, 10 volts, electrolytic
- *D1, D2—1 amp, 50 PIV silicon power diode, IN4001 or equal
- IC1—MC7400P
- IC2, IC3—MC7473P
- LM1 thru LM4—5-volt 50-mA panel lamp assembly
- *S1—spst slide switch
- S2—spst normally open pushbutton
- S3—spdt pushbutton
- Q1 thru Q4—2N5139 transistor (National)
- R1 thru R7—1000 ohms, 1/4-watt carbon
- *T1—8 Vct, 0.5-A transformer

MISC—2 1/2" x 2 3/4" PC board; PC Board stand-offs and hardware (4); case; Bottom feet (4); C4 mounting clip*; line cord and strain relief*; 4 lug terminal strip*; wirenut*; power supply hardware*; case hardware; wire; solder; etc . . .

***Parts for power supply**

NOTE: The following items are available from Southwest Technical Products, Box 16297, San Antonio, Texas, 78216:
Etched and drilled PC board No. 183, \$1.80
Complete kit of all parts, including prepunched and prefinished case but less power supply, No. 183-K, \$8.90

FIG. 2—COMPLETE WORKS of the binary counter. Note that the correct position of the IC's is indicated by the notch in one end.

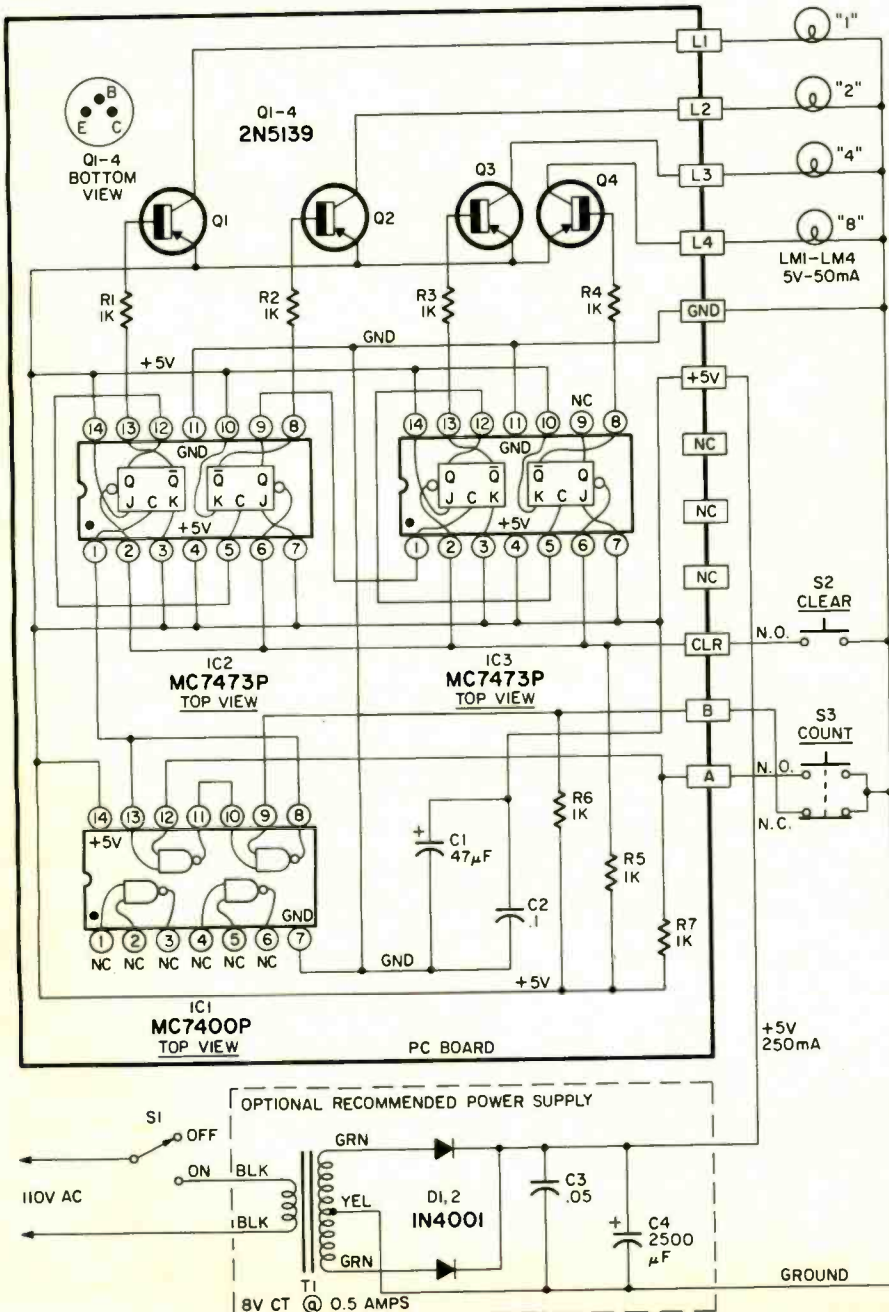

different symbols (0,1,2,3,4,5,6,7,8, and 9) to represent any number. To do this electronically in the decimal system, we'd have to recognize either ten different voltage levels, or, to get by with loose-tolerance circuits, a signal on one of ten different lines.

In the *binary* or *base two* system, we only need remember two states "1" and "0", or simply "yes" and "no". Just as we move over one decimal point when we get to ten, we move over one *binary point* when we get to two, with the "heavier" numbers always tacked on the left. The binary equivalents for the first sixteen numbers (0-15) are:

DECIMAL	BINARY					
	tens	units	8	4	2	1
0	0	0	0	0	0	0
0	1	0	0	0	1	
0	2	0	0	1	0	
0	3	0	0	1	1	
0	4	0	1	0	0	
0	5	0	1	0	1	
0	6	0	1	1	0	
0	7	0	1	1	1	
0	8	1	0	0	0	
0	9	1	0	0	1	
1	0	1	0	1	0	
1	1	1	0	1	1	
1	2	1	1	0	0	
1	3	1	1	0	1	
1	4	1	1	1	0	
1	5	1	1	1	1	

While binary numbers may appear longer than decimal ones, the looks are deceiving, because ten different states go into a decimal number, while only two are used in binary. To represent a "15" in true decimal form, at least eleven leads would be needed. In binary, it takes only four.

It turns out that binary is the most efficient possible way of storing information and performing arithmetic. It uses the simplest possible storage devices and requires the fewest interconnections. Practically all computers internally deal with binary and then make a *binary to decimal conversion* only when they interface with people. When computers (particularly small

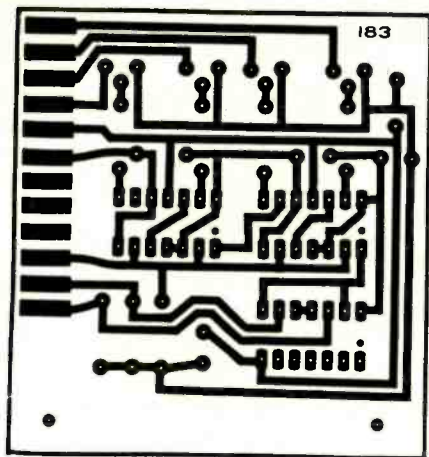
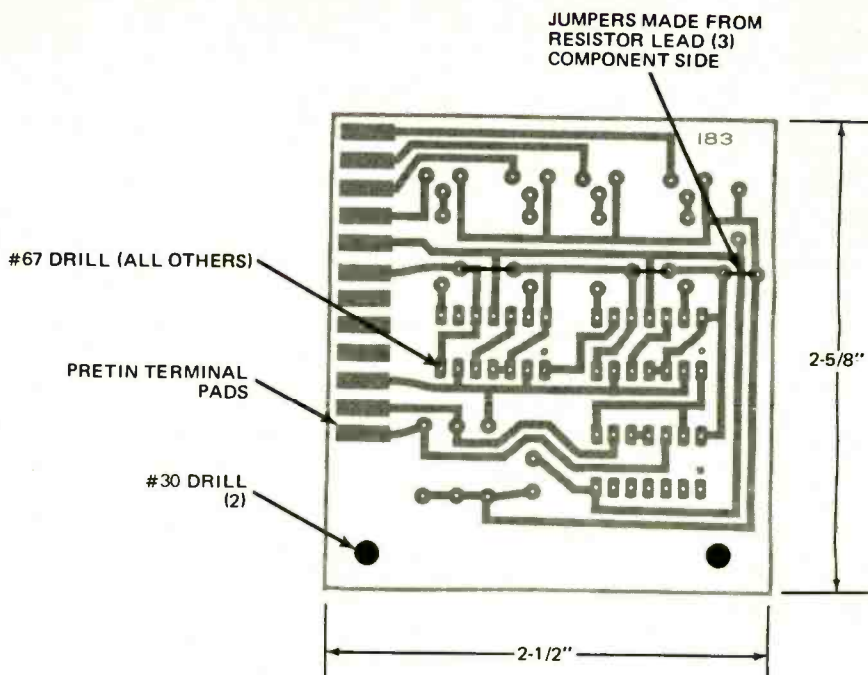

FIG. 3—FULL SIZE diagram of the printed-circuit board as seen from the foil side.

FIG. 4—DRILL AND JUMPER guide for the binary counter circuit board.

FIG. 5—OVERLAY DIAGRAM shows parts mounting positions on the circuit board.



ones) *must* deal with decimal, they re-encode it into a near-binary form, called *Binary Coded Decimal*. (BCD) Even in this form, the numbers can only be handled in 16/10 the space that would be needed for binary, a storage penalty of 60% in the size of a machine. Arithmetic operations in BCD are also proportionately more complex than in straight binary.

How it works

The logic diagram of the demonstrator is shown in Fig. 1. The circuit consists of a four-stage binary ripple counter formed by cascading two dual JK flip-flop TTL integrated circuits. The input COUNT commands from a pushbutton are made noiseless and bounceless by a set-reset contact conditioning flip-flop made of half of a quad two-input gate TTL integrated circuit. Contact conditioning on the CLEAR line is not needed, for resetting a counter to 0000 a dozen times has the same effect as only doing it once. The states of the counters are indicated by connecting the Q terminal on each flip-flop to a lamp through an inverting pnp driver transistor.

Construction hints

The schematic is in Fig. 2. A printed circuit board is recommended

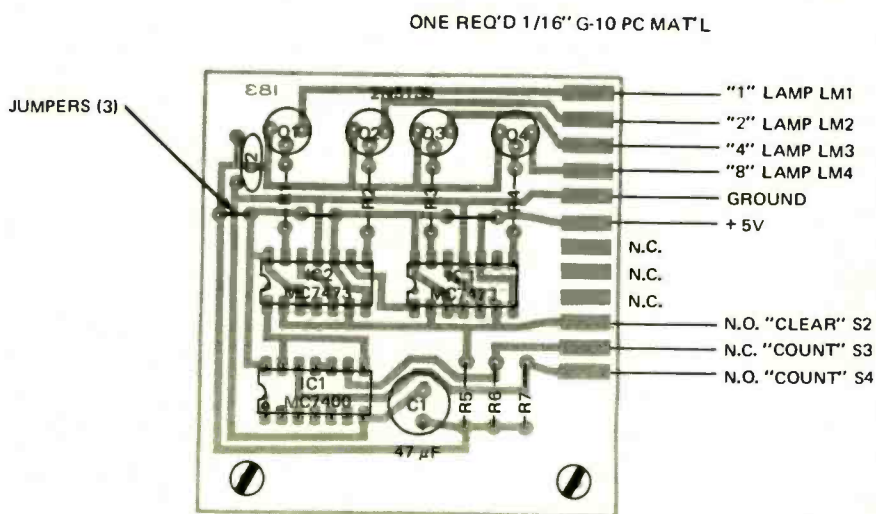

for component mounting. Figs. 3 and 4 show how the board is set up. Three jumpers are needed. These may be made out of cutoff resistor leads and are positioned as shown.

Component locations are shown in Fig. 5. Note the polarity on C1 and the three IC's. The code notch and dot is between pins 1 and 14.

The photos show the internal assembly details. The circuit board is

mounted on four standoffs along one end of the case, and leads are soldered directly to their respective pretinned terminal pads. The pilot lamps snap into place. Switch S1 is mounted with suitable hardware.

The binary counter may be powered by a high-quality 5-volt 250-mA lab bench supply, or the power supply shown in Fig. 2 may be built into the bottom of the case.

ROLLING PICTURE IN RCA KCS132A

The picture would roll constantly and would not lock-in vertically. When the vertical hold control was rotated the picture would roll up but never downward. The picture would roll slowly upward with the vertical hold control at top end of rotation. Undoubtedly, poor vertical sync. The vertical oscillator tube was changed. All voltages were quite

close to what they were supposed to be, yet the picture continued to roll.





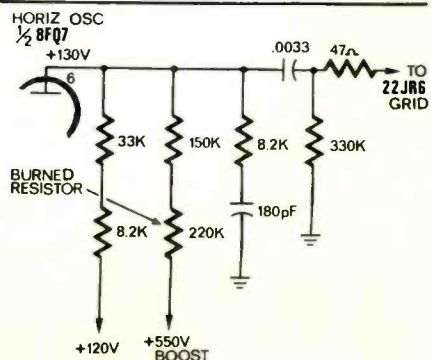

A check showed the feedback .0068- μ F capacitor at the grid (pin 4) of the 6EM7 was leaky. A replacement restored normal performance. After a few years this capacitor becomes leaky and the picture has a tendency to roll.—

Homer Davidson

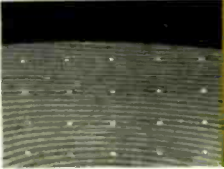

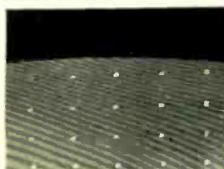
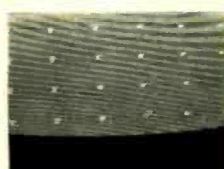
Kwik-Fix™ picture and waveform charts

© Forest H. Belt & Associates*

SCREEN SYMPTOMS AS GUIDES		VOLTAGE	WHERE TO CHECK FIRST	
SYMPTOM PIC	DESCRIPTION		WAVEFORM	PART
	Normal dots in top midarea			
	Normal dots in bottom midarea			
	Red and green won't converge at top or at bottom	Point A	WF1	P/S1 open R11 open D4 shorted
	Yellow dots won't converge with blue at top and bottom	no help	WF2	P/S2 open
	Can't converge top and bottom	no help	WF2	P/S3 open R14 open
	Red dots high at top; R14 no effect	no help	WF4	P/S4 open P/S5 open R14 open
	Convergence poor; green dots won't move	no help	WF6	L10 open R11 open R13 open
	Convergence poor; red dots won't move	no help	WF5	L9 open R10 open
	Convergence poor; blue dots won't move	no help	WF4	L8 open C7 open R9 open R12 open

P/S = Plug/socket terminal

NOTES:

Use this Guide to help you find which key voltage or waveform to check first, or to guide you to the causes of symptoms that don't have voltage or waveform clues.

Study the screen with a dot pattern injected to the set. Try each vertical dynamic convergence control. You'll find the most helpful trouble clues at the key test point indicated opposite whatever symptom you observe.

The Stages

This vertical dynamic convergence section is typical of those found in most American and Japanese color television receivers. Variant versions among brands generally differ only in rearrangement of controls or occasionally in the way input waveforms are derived.

Dividing the vertical dynamic convergence section into "stages" is difficult. A multiplicity of inputs all combine to form the waveshape applied to each vertical convergence coil. This results in considerable interaction, as you'll discover when you try adjusting the controls. The section gets only vertical sweep signals. Because of the low frequency (60 Hz), no adjustable inductances are used—only resistors or potentiometers.

Each vertical convergence coil is wound on the same core as its counterpart in the horizontal dynamic convergence section. Ignore whatever effect this has on operation of the vertical convergence section.

Signal Behavior

Three input signals from the vertical output section of the color receiver drive the vertical dynamic convergence circuit. Two of them come from windings on the vertical output transformer. The other is shaped a bit differently and comes

from the cathode circuit of the vertical output tube.

The first input waveform, WF1, comes from a center-tapped winding on the vertical output transformer, with the center tap grounded. (Some sets omit the center-tap on this transformer winding and use a phantom ground through two equal-value resistors.) The signal feeds across a pair of potentiometers. The slider of potentiometer R9 carries the signal to one end of blue vertical convergence coil L8; the slider setting determines what phase of signal reaches that end of the coil. The other potentiometer, R10, feeds the signal to one end of the red vertical dynamic convergence coil; the pot sets the phase.

Another vertical-sweep input waveform comes from a different center-tapped winding on the vertical output transformer. The tap of this winding is not grounded. Potentiometer R14 bridges the whole winding. Its slider selects whichever phase is appropriate for the particular color-GRT gun structure. The slider of R14 carries the selected polarity of waveform to a slider on potentiometer R13, which bridges the red and green vertical coils—not in parallel, but as if the coils were in series. Adjusting R13 applies the signal from R14 more to one coil or the other. The center tap of this same winding is the common return for both red and green vertical coils.

Adjusting R13 applies the signal from R14 more to one coil or the other. The center tap of this same winding is the common return for both red and green vertical coils.

Another vertical-sweep input waveform comes from a different center-tapped winding on the vertical output transformer. The tap of this winding is not grounded. Potentiometer R14 bridges the whole winding. Its slider selects whichever phase is appropriate for the particular color-GRT gun structure. The slider of R14 carries the selected polarity of waveform to a slider on potentiometer R13, which bridges the red and green vertical coils—not in parallel, but as if the coils were in series. Adjusting R13 applies the signal from R14 more to one coil or the other. The center tap of this same winding is the common return for both red and green vertical coils.

Adjusting R13 applies the signal from R14 more to one coil or the other. The center tap of this same winding is the common return for both red and green vertical coils.

(copy continues on page 50)

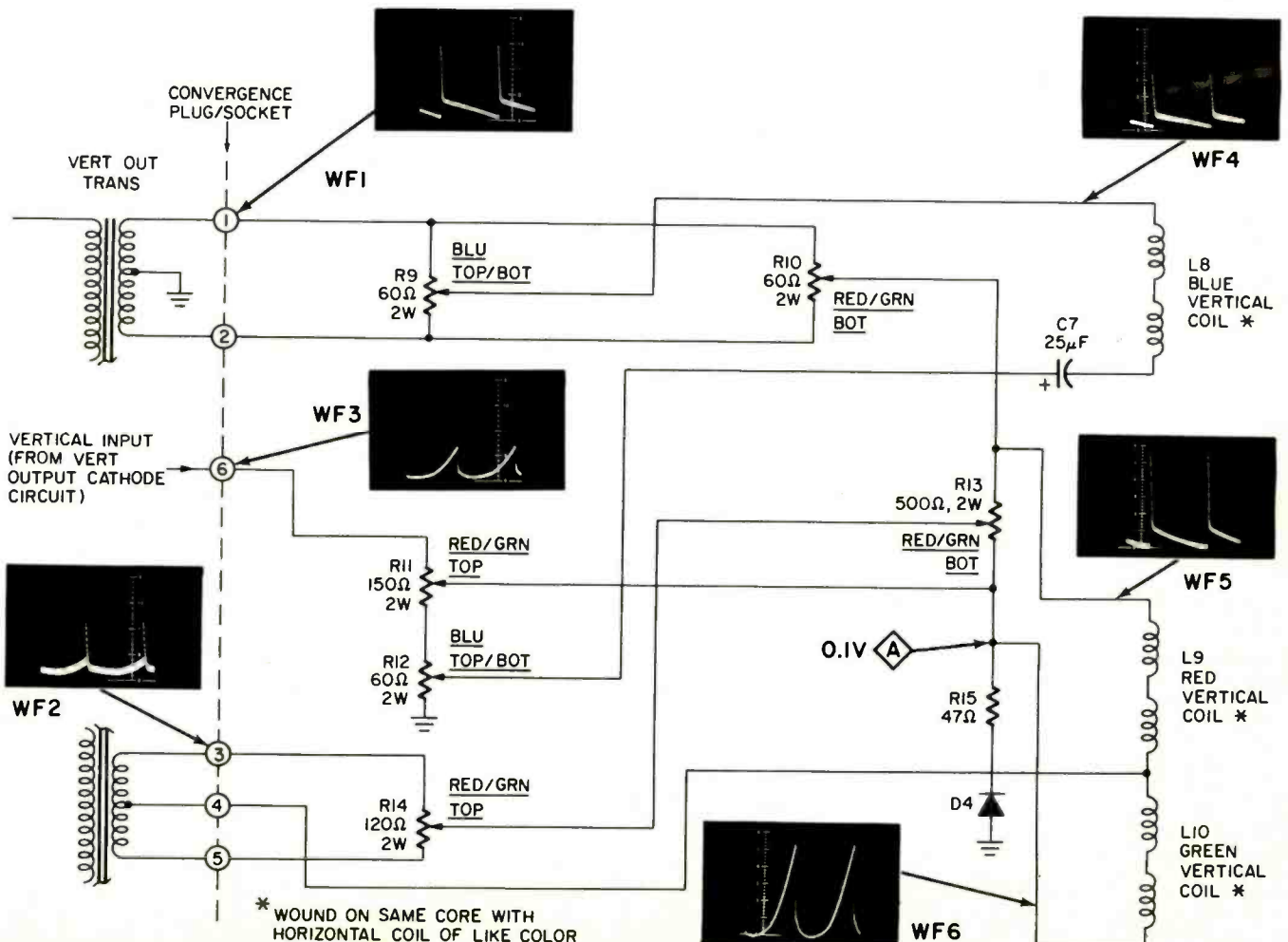

DC VOLTAGES AS GUIDES

Voltage change	to zero	very low	low	slightly low	slightly high	high
Test point A Normal -0.1 V	D4 open D4 shorted R15 open					







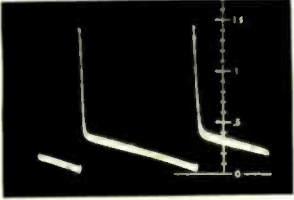

NOTES:

Use this guide to help you pinpoint the faulty part.
Measure the one key voltage with a vtvm or feivom.

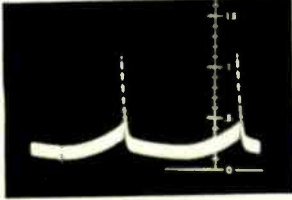
Notice which part is listed as possibly causing any change you find.

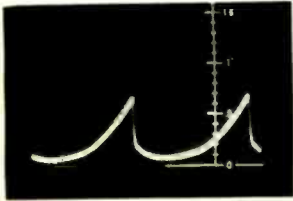
For more help to further narrow down the faulty part, see the Waveforms Guide.

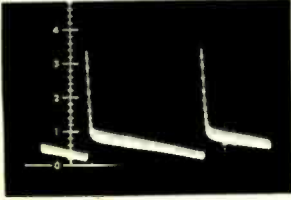
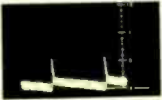
WAVEFORMS AS GUIDES

V p-p low	V p-p high	V p-p zero	Changed Shapes			
 <p>WF1 Normal 15 V p-p</p> <p>Taken conveniently at the convergence plug/socket, this waveform comes from a winding of the vertical output transformer. The winding is center-grounded. Amplitude may vary with settings of VERTICAL LINEARITY and HEIGHT in the receiver, but only slightly.</p>			 <p>10 V p-p P/S1 open</p>			
 <p>WF2 Normal 10 V p-p</p> <p>Comes from tapped (but not grounded) winding of vertical output transformer. Has trapezoidal shape, but with some parabolic signal. Some WF3 mixes in at certain settings of R14, R13, and R11. Any of these controls can alter the shape of this waveform, but shape shown is for "normal" convergence settings for average picture-tube gun structure.</p>			 <p>6 V p-p P/S1 open</p>			
 <p>WF3 Normal 7 V p-p</p> <p>Comes from vertical output cathode, through large-value capacitive divider that imparts integrated parabolic shape. Best place to scope is at convergence plug/socket terminal. Amplitude may depend on settings of Vertical Linearity in receiver, but shape doesn't alter much.</p>			 <p>10 V p-p P/S1 open</p>			
 <p>WF4 Normal 4.5 V p-p</p> <p>Taken at "high" end of blue vertical convergence coil. Consists mostly of trapezoid from vertical output transformer, with phase selected by R9. Can be completely reversed in polarity, depending on conditions, and still be normal. Amplitude, too, depends on settings of controls (R9 and R12). Value given and shape shown is average.</p>			 <p>0.5 V p-p R9 open</p>			
P/S3 open P/S5 open R14 open		P/S2 open R11 open R12 open		 <p>10 V p-p R9 open</p>		

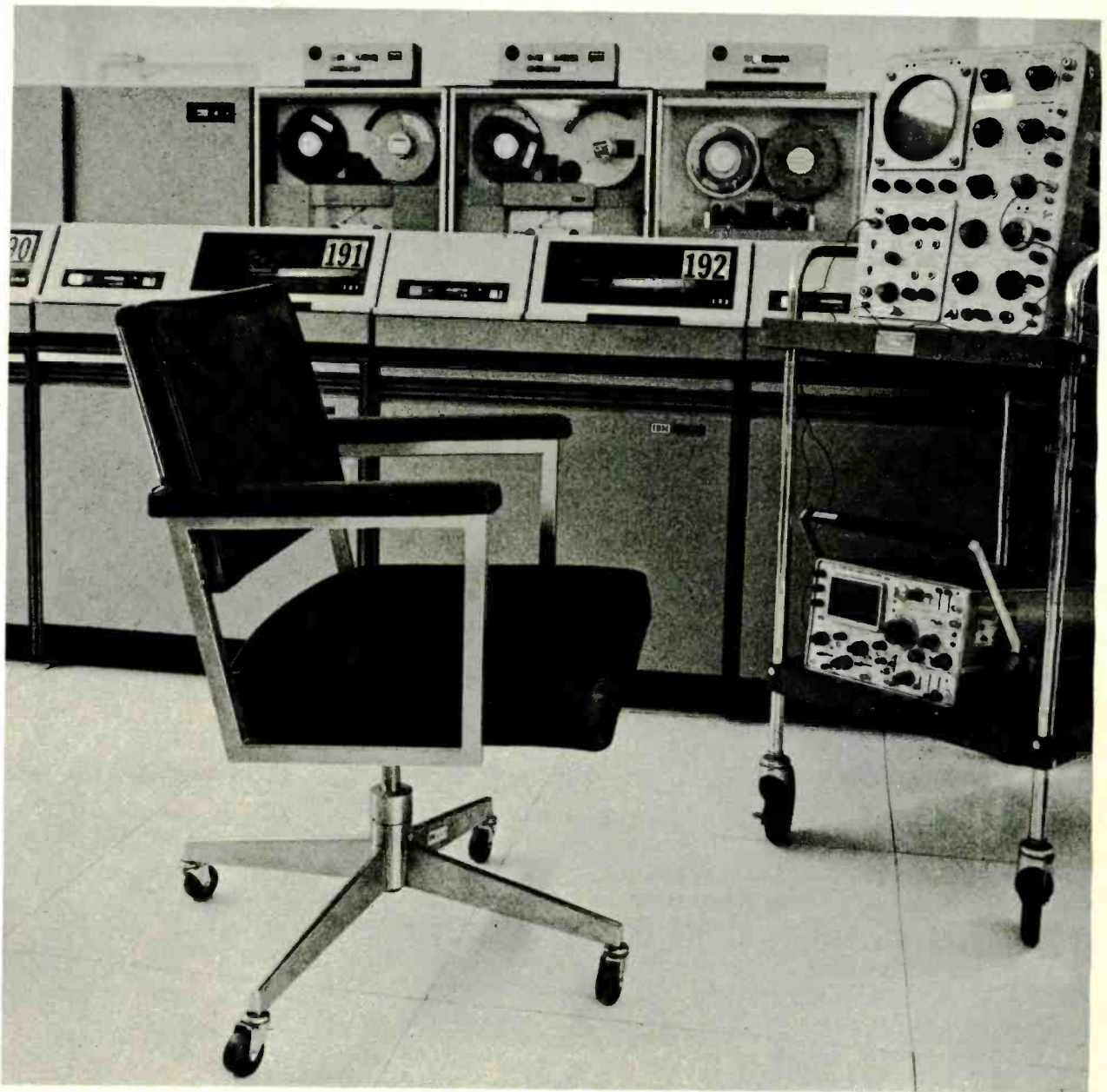

This important job (and its big income) is reserved for a qualified electronics technician. It can be you!

It's a fact. There are *thousands* of jobs like this one available *right now* for skilled electronics technicians. What's more, these men are going to be in even *greater* demand in the years ahead. But how about you? Where do you fit into the picture? Your opportunity will never be greater . . . so act *now* to take advantage of it. The first step? Learn electronics fundamentals . . . develop a practical understanding of transistors, trouble-shooting techniques, pulse circuitry, micro-electronics, computers and many other exciting new developments in this growth field. Prepare yourself now for a job with a

bright future . . . unlimited opportunity with lasting security . . . prestige and a steadily growing paycheck.

Cleveland Institute of Electronics courses have been stepping stones to good jobs in electronics for thousands of ambitious men. Why not join them? You can learn at home, in your spare time, and tuition is remarkably low. Read the important information on the facing page. Then fill out the postage-free reply card and drop it in the mail today. Without obligation we'll send you all the details. But act now . . . and get *your* high-paying job just that much sooner.

How You Can Succeed In Electronics ... Select Your Future From Seven Career Programs

The "right" course for your career

Cleveland Institute offers not one, but seven different and up-to-date Electronics Home-Study Programs. Look them over. Pick the one that is "right" for you. Then mark your selection on the bound-in reply card and send it to us. In a few days you will have complete details... without obligation.

1A. Electronics Technology

A comprehensive program covering Automation, Communications, Computers, Industrial Controls, Solid-State Devices, and preparation for a 1st Class FCC License.



1B. Electronics Technology with Laboratory

Includes all areas of Course 1A including 1st Class FCC License preparation. In addition, student receives 161-piece Electronics Laboratory and 17 "lab" lessons for "hands-on" experience.



2. Broadcast Engineering

Here's an excellent studio engineering program which will get you a 1st Class FCC License. Now includes Video Systems, Monitors, FM Stereo Multiplex, Color Transmitter Operation and Remote Control.



3. First Class FCC License

If a 1st Class FCC ticket is your goal, this streamlined program will do the trick and enable you to maintain and service all types of transmitting equipment.

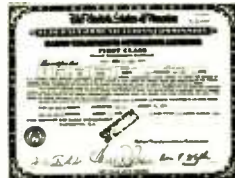

4. Electronic Communications

Mobile Radio, Microwave and 2nd Class FCC preparation are just a few of the topics covered in this "compact" program. Highly recommended for jobs with telephone companies.



5. Industrial Electronics & Automation

This exciting program includes many important subjects such as Computers, Electronic Heating and Welding, Industrial Controls, Servo-mechanisms and Solid-State Devices.



6. Electronics Engineering

A college-level course for men already working in Electronics... covers Steady-State and Transient Network Theory, Solid-State Physics and Circuitry, Pulse Techniques, Computer Logic and Mathematics through Calculus.



An FCC License... or your money back!

The CIE courses described here will prepare you for the FCC License specified. In fact, we are so certain of their effectiveness we offer this warranty: Should you fail to pass the FCC examination after completing a CIE license preparation course, we will refund all tuition payments. You get an FCC license... or your money back. This warranty is valid during the entire completion time established for your course.

CIE's AUTO-PROGRAMMED® Lessons help you learn faster and easier

Cleveland Institute uses the new programmed learning approach. Our Auto-Programmed Lessons present facts and concepts in small, easy-to-understand bits... reinforce them with clear explanations and examples. Students learn more thoroughly and faster through this modern, simplified method. You, too, will absorb... retain... advance at your own pace.

Employment Assistance available for all CIE students... at no extra cost

Once enrolled with CIE, you will get a bimonthly listing of high-paying, interesting jobs available with top companies throughout the country. Many CIE graduates hold such jobs with leading companies like American Airlines, AT&T, General Electric, General Telephone and Electronics, IBM, Motorola, Penn Central Railroad, Raytheon, RCA, Westinghouse and Xerox... to name a few.

CIE Lessons are continually up-dated

All lesson books and materials from CIE are continually revised or replaced according to the current needs of industry and the rapidly advancing and changing state of the art.

New Revised G.I. Bill Benefits:

All CIE courses are approved for full tuition refund under the new G.I. Bill. If you served on active duty since January 31, 1955, OR are in service now with more than 180 days active duty, check box on reply card or coupon to get latest G.I. Bill information.

CIE Cleveland Institute of Electronics
1776 East 17th Street, Cleveland, Ohio 44114

If card has been removed, mail this coupon for 2 FREE BOOKS

Cleveland Institute of Electronics
1776 East 17th Street, Cleveland, Ohio 44114

Please send me without cost or obligation:

1. Your full-color book, "Succeed in Electronics."
2. Your book on "How To Get a Commercial FCC License."

I am especially interested in:

- | | | |
|---|--|--|
| <input type="checkbox"/> Electronics Technology | <input type="checkbox"/> Broadcast Engineering | <input type="checkbox"/> Electronic Communications |
| <input type="checkbox"/> Electronics Technology with Laboratory | <input type="checkbox"/> First Class FCC License | <input type="checkbox"/> Industrial Electronics & Automation |
| | <input type="checkbox"/> Electronics Engineering | |

Name _____ Age _____
(please print)

Address _____

City _____ State _____ Zip _____

Veterans & Servicemen:
check here for G.I. Bill information.

Accredited Member National Home Study Council.

RE-99

WAVEFORMS AS GUIDES

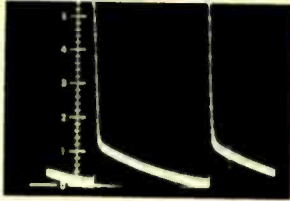

WF5 Normal 4.5 V p-p

Taken at "high" end of red vertical convergence coil. Consists mainly of trapezoid from same transformer winding as WF4, but with some of WF2 and WF3 mixed in by R13. Amplitude, shape, and polarity depend on control settings needed to put the dogs nearest perfect convergence; those shown are average.

P/S2 open
P/S3 open
P/S5 open
R14 open



10 V p-p
P/S1 open



10 V p-p
R10 open

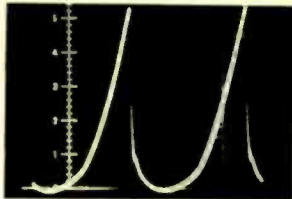

WF6 Normal 4.5 V p-p

Taken at "high" end of green vertical convergence coil. Consists mainly of parabolic waveform from vertical output cathode, but modified by WF9 and WF10 that are mixed in by R13. Amplitude depends on control settings, but shape varies little. Value given is for average picture-tube gun structure.



4 V p-p
R11 open



3 V p-p
R11 open

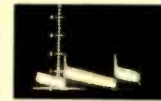

2V p-p
R11 open

NOTES:

Use this Guide and the Voltages Guide to help you pin down fault possibilities.

Set controls for the best convergence possible, even if it's not correct convergence over the whole CRT face. Use dot pattern.

Use the direct probe of the scope. Set the scope sweep to about 30 Hz, to display two cycles.

Check the six waveforms at the six key test points.

Note amplitude. If it's low or high, check the parts listed under those columns.

Note waveshape. If there's a change that matches one shown, check the parts indicated.

The third signal input, taken from the cathode of the vertical output tube, feeds two potentiometers in series. (In some chassis, these potentiometers are in parallel, and one of them has a resistor between its lower end and ground.) The slider of potentiometer R11 feeds a signal to one end of the green vertical coil, much the same as R10 feeds a signal to one end of the red vertical coil. R15 and D4 shape this particular waveform to some extent.

You could consider R13 a mixing pot for signals from (a) R10, (b) R11, and (c) R14. The result goes to the red and green convergence coils.

Potentiometer R12 also takes signals from the vertical output cathode. R12 is in series with R11. (In some designs, they are in parallel.) The slider of R12 feeds signal to one end of the blue vertical coil—the end opposite that fed by R9. Capacitor C7 has a very small effect on shaping. In some chassis, C7 is omitted and replaced by direct connection.

Looking at the three coils, you can see that the waveshape developing across them—that is current developing in them—is a result of differently phased waveforms fed at each end of each coil. The resulting currents make the magnetic fields that "warp" the CRT beams that correspond to the colors of the coils.

DC Distribution

The only dc in this vertical convergence section is developed by D4. Capacitors in the feed line from the vertical output cathode block any dc that might come from there. The dc path to ground through R11 and R12 keep the voltage quite

low—a mere fraction of a volt. This clamp voltage is positive (it's negative in the horizontal convergence section).

Station and Control Effects

How much or how little signal is being picked up from a station has no effect on the waveforms in the vertical convergence section. The waveforms come from the vertical output system, which runs whether there is sync or not. However, the six vertical-convergence potentiometers definitely affect waveforms. This effect is easiest to see with a dog pattern on the picture tube face.

Control R10 affects red and green dots in the area midway across the bottom of the screen. As you twist the potentiometer knob, the red and green dots move further apart or squeeze closer together sideways. Control R13 affects the same dots, but it moves them vertically closer to or further away from each other. The object is alternately to adjust R10 and R13 until the red and green dots superimpose and form yellow dots (with blue killed).

R11 and R14 have a like effect on the dots midway along the top edge of the picture tube screen. As you twist the knob of R11, red and green dots are pulled closer together or pushed further apart in the sideways direction. As you twist R14, the same dots approach or spread apart vertically. Again, the task is to superimpose them to form yellow dots.

R9 and R12 move blue dots at the top and bottom midpoints on the picture tube screen. But the dots move in a little different manner than with the red/green controls. R12 moves either or both sets of dots upward or downward simul-

equipment report

Hickok CRO-5000 Triggered Sweep Scope



Circle 55 on reader service card

THE HICKOK CRO-5000 OSCILLOSCOPE is quite an instrument. It's described in the manual as a "general-purpose high-frequency scope for use in development laboratories, production testing and precision electronics servicing work." I'll take that.

The spec's are impressive: vertical amplifier bandwidth up to 25 MHz with usable response to 50 MHz; ac or dc coupled input, with the choice of a high-pass or low-pass filter for getting the best results; triggered sweep, with a selector to allow triggering on either the positive- or negative-going slope of the waveform; a horizontal sweep from 50 nsec per division up to two seconds/division; a built-in calibrator, square wave at 1.0 kHz, and so on.

The horizontal sweep (TIME/DIV) and vertical gain (VOLTS/DIV) each are controlled by a single knob. Calibration is in "1-2-5-" steps for both. A continuous control for the horizontal sweep is provided by a center-knob. To calibrate, it is turned full CCW until you feel the switch click. From then on voltage and frequency can be read directly from the dials.

Any voltage and frequency can lit-

erally be read with a "twist of the wrist," and counting the divisions of the graticule covered by the waveform. This is possibly the fastest scope I have ever used in that respect. Dc levels in the waveform can be read just as easily. The input switch is set to dc, and the undeflected line adjusted to the bottom line of the graticule. Ac peak-to-peak voltages are read by counting divisions and multiplying by the calibration setting. (4 divisions, at 1.0 V/div = 4.0 volts peak-to-peak.) On the highest voltage range, 50 V/div, you can read 300 V peak-to-peak, since the graticule has 6 major divisions. With the 10:1 low-capacitance probe, the maximum voltage is multiplied by 10, for a reading of 3,000 V peak-to-peak.

You can use any of three vertical inputs: AC-LF, which is flat from 5 Hz up to about 100 kHz; AC-HF with a high-pass filter, flat from about 500 Hz up to more than 10 MHz, with only -3 dB at 25 MHz, and usable response to 50 MHz, or dc with the same hf response as the AC-HF position, and low-frequency response all the way down.

The triggered-sweep can be used for "instant-locked" observation of any

waveform. Triggering on the positive- or negative-going slope of the wave makes it easy. Just push the + or the - button. For setup, or for applications where the triggered sweep isn't necessary, the AUTO button is pushed. This switches the sweep back to manual, and it runs constantly. This is useful for the quick testing through any kind of circuitry, to find out where the signal stops. As usual, we put the CRO-5000 through its paces on the test bench on actual TV troubles. The CRO-5000 came through with flying colors. It is everything a technician could possibly want.

All of the operating controls are logically placed. Vertical and horizontal controls have large knobs, and are set close to each other. Calibration is plain and easy to read. The TRIGGER LEVEL control is near them, and these are the most-used ones. The position controls are placed below and up the right side of the screen. All the rest are pushbuttons, in a handy row along the bottom of the front panel.

External triggering can be used, as well as internal and line-sync. External horizontal sweep can also be used, through a jack on the panel. These are controlled by the pushbuttons.

A special flat-face CRT is used, with a rectangular screen. This is recessed to reduce glare. However, the trace is very bright and sharp, and it could be used in any room even with high-intensity lighting.

There was only one thing I didn't like about this tremendous scope—having to send it back! R-E

KWIK FIX TROUBLESHOOTING CHARTS (concluded)

taneously. R9, on the other hand, moves top blue dots upward and bottom blue dots downward or else moves bottom blue dots upward and top blue dots downward. The objective is to arrange the blue dots so they superimpose with yellow dots to form white dots.

If blue dots at the top or bottom don't align correctly, you may have to get them in nearly the same positions (with respect to yellow) as those in the center of the pix tube and then converge with the static magnets. That was done before any convergence was started, but you may have to readjust static convergence from time to time all through dynamic convergence.

Quick Troubleshooting

Almost the only components in the vertical dynamic convergence section are the six controls and the three con-

vergence-yoke coils. The dots on the screen—or their lack of movement—generally give enough clues to tell whether a part is bad or not.

If a coil is open, none of the controls that move that particular color of dot has any effect. The same controls might affect other dots. For example, if the red coil is open, the red/green controls (all except R9 and R12) will effect green dots but red dots just sit there. If green dots won't move and red will, the green coil is probably open. If the blue coil is open, red and green dots move, but neither R9 nor R12 will move blue dots.

On the other hand, if only one control is bad, the other controls will usually affect the dots they should.

Another easy way to check out convergence-board components is with an ohmmeter. The only trouble is, you have to disconnect one end of just about any component on the board if you're going to see what its resistance is. Generally, on the vertical convergence portion of the panel, you can get a better idea from how the controls affect the dots they are supposed to control. R-E

ALTHOUGH THE HARMONIC-DISTORTION meter and the intermodulation analyzer are *the* specialized instruments for measuring audio distortion, the oscilloscope can also be useful. A scope is particularly helpful in identifying the type(s) of distortion in various trouble situations. The scope may be used directly, or with a harmonic-distortion meter. Nearly all tests of hi-fi equipment place exacting requirements on scope characteristics, as will be explained.

Sinewave displays

Let's start with a review of sine-wave displays. Fig. 1 is the basic test setup. The load resistor should have a resistance roughly that of the rated amplifier output impedance and must also have a power rating at least equal to the maximum rated power output of the amplifier. Note that the audio oscillator must have a lower percentage distortion rating than the amplifier under test.

fore it becomes easy to see, when the method shown in Fig. 1 is employed. For example, Fig. 2 shows 1-kHz sine-

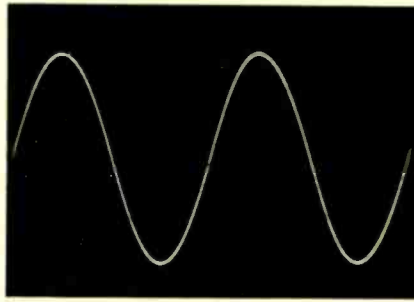

FIG. 2—REFERENCE PATTERN when audio oscillator is connected direct to the scope.

wave patterns displayed when the output from the audio oscillator is fed directly into the vertical input terminals of the scope. Although high-quality instruments were used in this example, there is of course a slight amount of distortion. But even a highly experienced

lustrated in Fig. 2, it is very difficult to discern the difference.

When an amplifier operates at 2% harmonic distortion, the operator may be able to observe a departure from the reference pattern. For example, Fig. 4 is an example of 2% harmonic distortion. In this case, the distortion is caused by positive peak compression. This is one of the most common forms of audio distortion: it is caused by a nonlinear

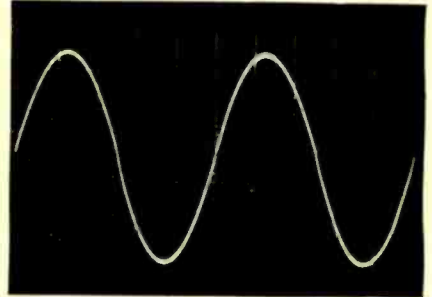

FIG. 4—TWO PER CENT MORE distortion than the waveform of Fig. 2 becomes noticeable.

Scope Analysis of

*The technician's most valuable
for a specialized*

Similarly, the vertical amplifier of the scope must have a lower distortion figure than the amplifier rating. Otherwise, the test results become meaningless—we will be measuring test-equipment deficiencies rather than amplifier performance.

Tests can be made at various levels of amplifier power output, but the most useful test is usually the one made at maximum rated power output. Most types of distortion show up most prominently at maximum output, although there are a few exceptions. For example, crossover distortion is greater at *low* levels. Therefore, low-level performance must not be ignored.

Distortion must be appreciable be-

scope operator could not state the approximate percentage nor identify the types of distortion in the display.

A reference pattern like that of Fig. 2 should always be set up and observed before making measurements. Not only does it serve as a check on instrument condition, but it also establishes a standard for subsequent observations. Next, let us consider the pattern that is displayed when the 1-kHz sine-wave voltage is passed through an amplifier operating with 1% harmonic distortion. Fig. 3 shows the resulting pattern. Note that

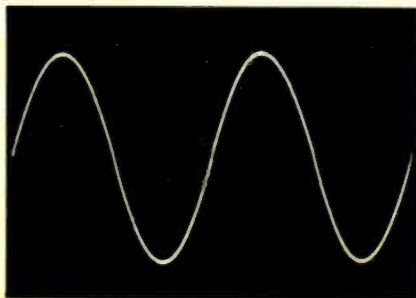

FIG. 3—THIS WAVEFORM has one percent more distortion than the one shown in Fig. 2.

although this waveform contains 1% more distortion than the waveform il-

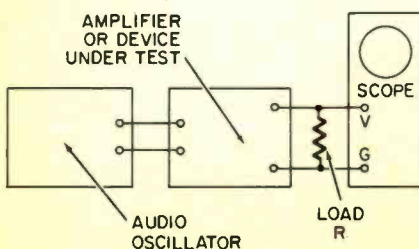

FIG. 1—TEST SETUP for sine-wave display.

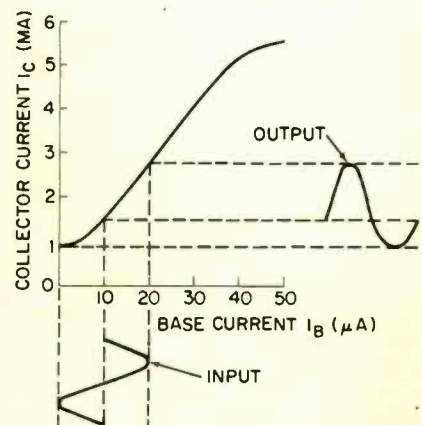

FIG. 5—DISTORTION due to wrong bias.

transfer characteristic, as depicted in Fig. 5. In this example, the bias point is incorrect. Note that even when the bias point is correct, overdriving inevitably results in double-peak compression or clipping, as shown in Fig. 6.

Higher percentages of distortion are progressively easier to observe in sine-wave patterns, as in Fig. 7. These are also examples of positive-peak compression. The relation of second-harmonic distortion to peak compression or clipping is depicted in Fig. 8. In-

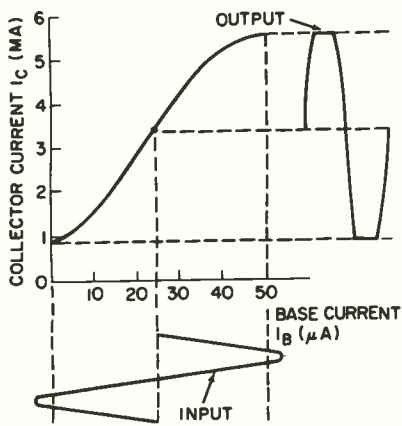

FIG. 6—OVERDRIVING, even with correct bias, will cause a clipping type of distortion.

roducing a second harmonic results in reducing one peak amplitude and increasing the other in the resultant complex waveform. (In general, we can state that unsymmetrical distortion is caused by even-order harmonics, while sym-

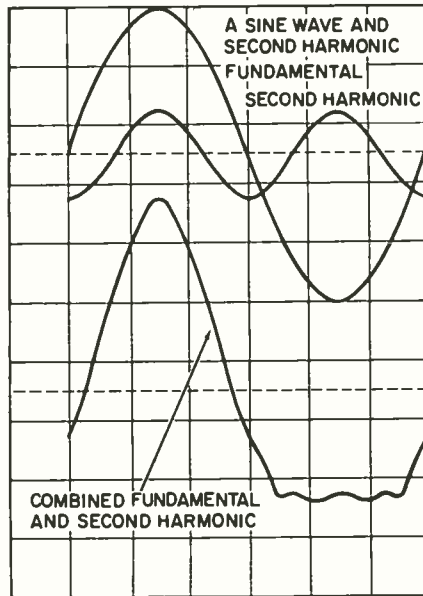

FIG. 8—SECOND HARMONIC distortion and its relation to peak compression or clipping.

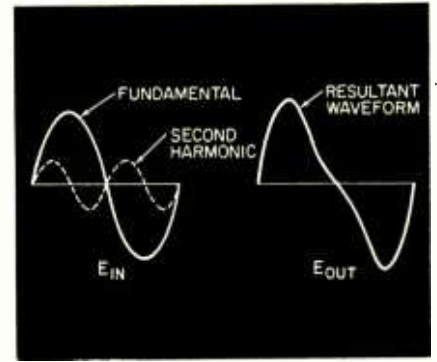

FIG. 9—MIRROR IMAGE DISTORTION due to phase of the second harmonic insertion.

more amplifier output voltage than input voltage; and since the horizontal amplifier usually has less gain than the vertical amplifier, the arrangement shown in Fig. 10 is generally most practical.

Audio Distortion

instrument can often substitute
audio analyzer

by ROBERT G. MIDDLETON

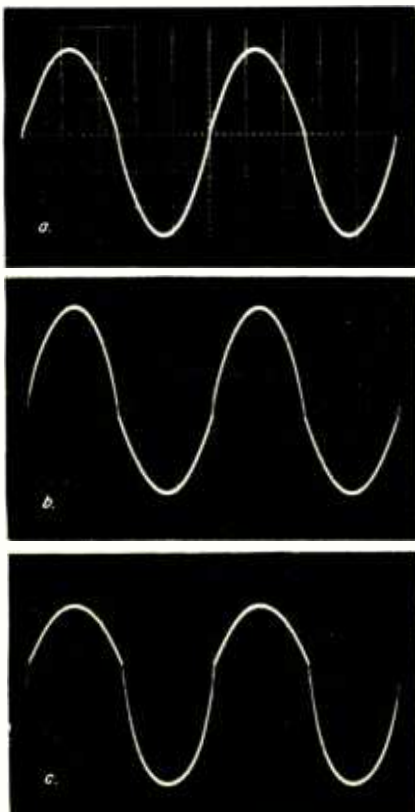

metrical distortion is caused by odd-order harmonics.)

Although the ear has little or no discrimination for phase distortion, the resultant waveform of a fundamental and second harmonic changes greatly with phase shift, and is very prominent in a scope pattern. As an example, if a second harmonic is introduced into a sine wave with the phase shown in Fig. 9, peak compression does not occur. Instead, a mirror-image type of nonlinear distortion takes place. Note also that a harmonic-distortion meter is "like" the ear in that it has little or no response to harmonic phase relations.

Lissajous displays

It is easier to discern small percentages of distortion in scope patterns if we use Lissajous patterns. Fig. 10 shows the basic test setup. A linear time base is not used. Instead, the amplifier input waveform is fed into the vertical channel of the scope, and the amplifier output waveform is fed into the horizontal channel. Although the amplifier roles could be reversed, we usually have

FIG. 7—POSITIVE PEAK COMPRESSION: a—3% harmonic distortion, b—5%, c—10%.

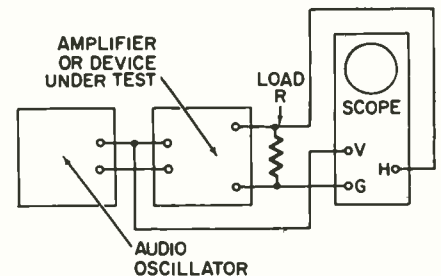

FIG. 10—LISSAJOUS DISPLAYS can be obtained with the test setup of this figure.

Note that the audio oscillator need not meet hi-fi standards to be useful in Fig. 10. That is, the test setup is largely immune to distortion in the audio-oscillator output waveform. On the other hand, the scope must have hi-fi vertical and horizontal amplifiers. Otherwise distortion in the scope will be charged against the amplifier under test in most cases. It is advisable to make a preliminary equipment check by omitting the amplifier in Fig. 10 and driving the scope's vertical and horizontal amplifiers directly from the audio oscillator. If the scope has hi-fi amplifiers, a straight diagonal line will be displayed, as illustrated in Fig. 11-a.

Since no scope can be absolutely perfect, there is a slight amount of dis-

ortion in the pattern on Fig. 11-a, although it cannot be discerned. Next, when an amplifier operating with 1% harmonic distortion is checked, we note that this amount of distortion is evident, although it might be overlooked by the inexperienced observer. Note in Fig.

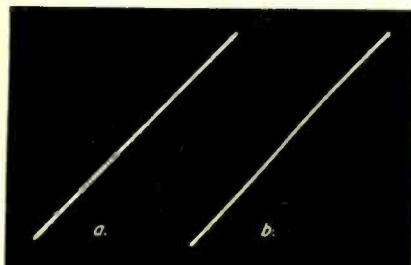

FIG. 11—AMPLIFIER OUTPUT Lissajous display. a—negligible, b—1% distortion.

11-b that if a straightedge is held against the displayed line, a definite curvature is apparent. This is also the case if we sight along the displayed line from end to end.

Although no industry standards have been established, it is generally agreed that high-fidelity reproduction entails a harmonic-distortion figure of less than 1%. Thus, the examples shown in Fig. 12 exceed high-fidelity limits.

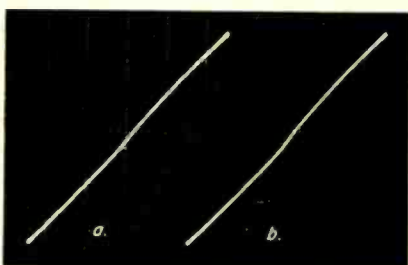

FIG. 12—INCREASING DISTORTION is easy to see. a—1.5%, b—2% harmonic distortion.

These tests were made at 1 kHz, which is the standard single-test frequency. The particular curvature in the patterns is characteristic of peak distortion, and is essentially independent of the test frequency. Fig. 13 shows similar patterns

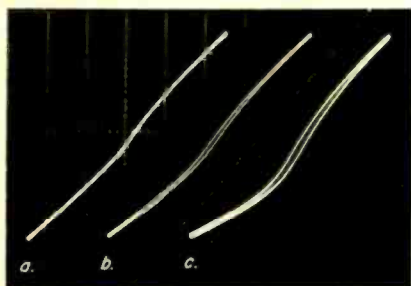

FIG. 13—LISSAJOUS PATTERNS for peak compression at 3, 5 and 10% harmonic distortion.

for higher percentages of distortion. Note that the traces are visibly separated for the examples of 5% and 10% distortion. This is an indication of harmonic phase shift, in comparison to the

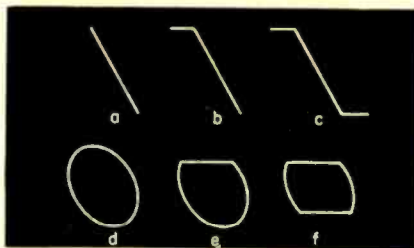

FIG. 14—CLASSIC AUDIO PATTERNS. a—no overload, no phase shift; b—peak clipping, no phase shift; c—double peak clipping, no phase shift; d—phase shift, no amplitude distortion; e—phase shift and peak clipping; f—phase shift and double peak clipping.

foregoing photos.

Fig. 14 depicts the basic amplitude and phase-shift Lissajous patterns. We observe that clipping produces a sharp discontinuity in the pattern. All ac-coupled audio amplifiers shift phase in the vicinity of their high-frequency and low-frequency cutoff points. A dc-coupled audio amplifier exhibits phase shift only in the vicinity of its high-frequency cutoff point, since its low-frequency cutoff point is zero Hz. As noted previously, the percentage of harmonic distortion due to crossover distortion increases as the output power is reduced.

Analysis of distortion products

An oscilloscope is also useful for checking harmonic-distortion products, as shown in Fig. 15. This application is

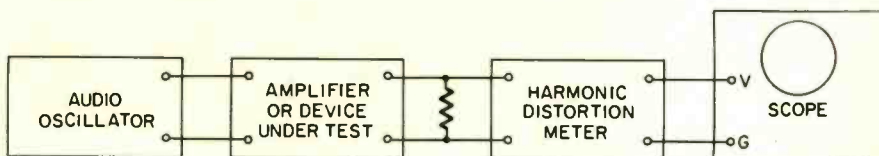

FIG. 15—HARMONIC DISTORTION TEST, setup for analyzing the distortion products.

least demanding on scope performance, and any service-type scope can be utilized. When the harmonic-distortion meter is adjusted to reject the test frequency (such as 1 kHz), the scope then displays the waveform of the distortion products. This is very seldom a second harmonic alone, a third harmonic alone, or a mixture solely of second and third harmonics. In most situations, we will find a distortion waveform that consists of a number of even and odd harmonics. However, one harmonic, such as the second or the third harmonic, is usually dominant. This can be determined by using the scope to measure the frequency of the complex distortion waveform.

Frequency can be measured easily if the scope has calibrated sweeps. For example, if the test frequency is 1 kHz, and the period of the distortion waveform is 500 μ s, we know that the dominant distortion product is the second harmonic. On the other hand, if the scope does not have calibrated sweeps, a simple comparison test will determine

the period of the distortion waveform. The scope is adjusted to display one complete cycle when the harmonic-distortion meter is set to feed the input waveform through. Then, when the harmonic-distortion meter is adjusted to reject the test frequency, we observe how many cycles of the distortion waveform are displayed on the scope screen. For example, if three cycles are displayed, we know that the dominant distortion product is the third harmonic.

Note that phase relations are not troublesome in most cases. For example, Fig. 16 depicts a distortion waveform made up of a dominant second harmonic with a subordinate sixth harmonic. In these two examples, the sixth harmonic has zero phase and 180° phase respectively, with respect to the second harmonic. However, the number of zero crossovers remains the same, and the period of the complex distortion waveform is unchanged.

Finally, we may note that apparent harmonic distortion might be hum distortion in whole or in part. In either case, scope analysis of the distortion waveform will quickly show whether 60-Hz or 120-Hz hum voltage may be present.

Conclusion

Although the harmonic-distortion meter is the basic instrument for measurement of audio distortion, the os-

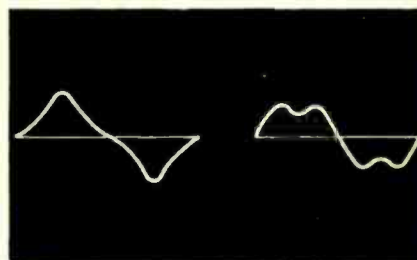
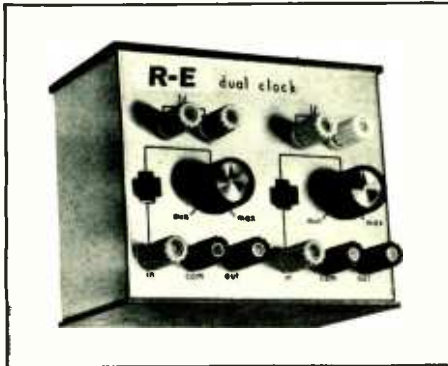
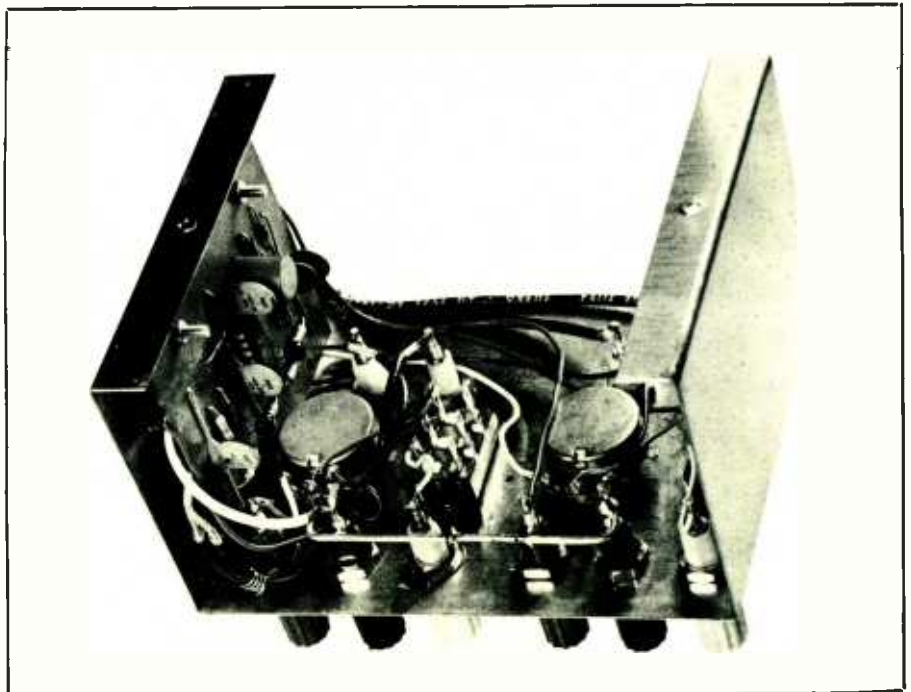

FIG. 16—THESE TWO distortion waveforms are alike except for relative phase relations.

cilloscope is a useful supplementary instrument. When an HD meter is not available, a scope can be used for qualitative and even for rough quantitative analysis of distortion. The most useful approach is to display an input-output Lissajous pattern. To obtain meaningful results, both the vertical and the horizontal amplifiers of the scope should have hi-fi characteristics. A scope is also useful for checking harmonic-distortion products in audio circuits when used with an harmonic-distortion meter. **R-E**

Universal dual signal source for audio testing, digital logic, electronic music synthesis, SWL and ham BFO'S, panic alarms, sirens, birdcalls, calibrators, signal generators, squawkers, etc. . . .



Solid-State Dual-Clock Generator

by DON LANCASTER

HERE'S A UNIVERSAL SHORTPROOF DUAL oscillator that virtually anyone in electronics can use and easily afford. Snap on a capacitor and out comes a stable, buffered, 3-volt high symmetrical square wave of any frequency you want from once every ten seconds up to 30 MHz. If you want, you can knob tune the frequency over a 3.5 to 1 range with a single capacitor, or voltage control the thing with an external 3- to 5-volt dc control voltage.

The output directly drives TTL, RTL, DTL, or low-threshold MOS integrated circuits, and with a good power supply, the frequency is stable enough for music synthesis and metronome work. A speaker can be driven directly by the output to useful volume levels. If you need more stability, just replace the capacitor with a crystal from 3 to 30 MHz and you have a crystal-controlled source.

You can use just one of the clocks, use both clocks separately, or you can let the one clock control the other one, useful for sirens, two-tone alarms, toneburst testing, etc. Hams and SWL's might like to put a crystal calibrator on one half and a bfo on the other.

Cost and complexity? A single \$2.40 integrated circuit does the whole job, helped along with two optional 25¢ transistors. You provide the power supply—either 5 volts from a regulated bench source or 4.5 to 6 volts worth of D cells.

Construction hints

The schematic is in Fig. 1. The heart of the circuit is IC1, a dual buffered TTL astable multivibrator. The multi's frequency is controlled by an external capacitor along with a control voltage input. For no frequency adjustment, you clamp the control voltage to +5. For pot control, you run it to a pot that lets the voltage run from +2.5 to +5. Or for external use, you bring out the voltage control directly.

Note that there are three supply voltages and three ground connections that must be made to the IC. B+ to the oscillators must be R-C decoupled to prevent interaction between both circuit halves. The oscillators *cannot* be gated by applying and removing B+ because of a sneak path through from the voltage control input. Thus, to elec-

tronically gate (or turn on and off) the oscillator, you break the ground side to the oscillator. This is done optionally by transistors Q1 and Q2. If you don't need gating, just replace these transistors with a solid ground connection. +2 to +5 volts at the GATE terminal turns ON the clock. Ground shuts it off.

A small printed circuit simplifies assembly. You can make your own using the layout guide of Fig. 2, along with the mechanical and layout guides of Figs. 3 and 4. Be sure to observe the code notch and dot when inserting the IC and use a low-wattage iron and fine solder during assembly.

The printed circuit mounts on the side of a small case, with each clock's input, output, and capacitor binding posts going on the top, along with a frequency-adjust pot. Since this is a 30-MHz device and circuit, lead routing can be critical and cause noise and interaction problems. To solve these problems, use short pieces of coax (miniature 50-ohm RG-174 is ideal) to reach the capacitor binding posts. Use one piece of coax for each binding post and ground the coax only at the printed-circuit end. Also, use a sturdy No. 12 or

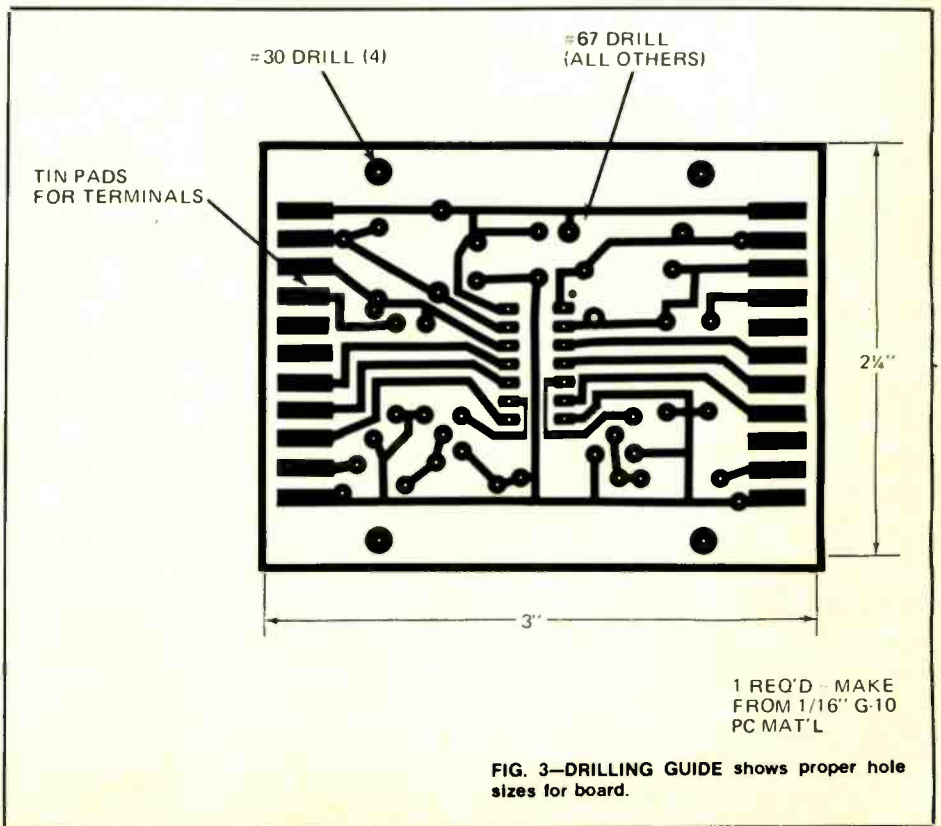
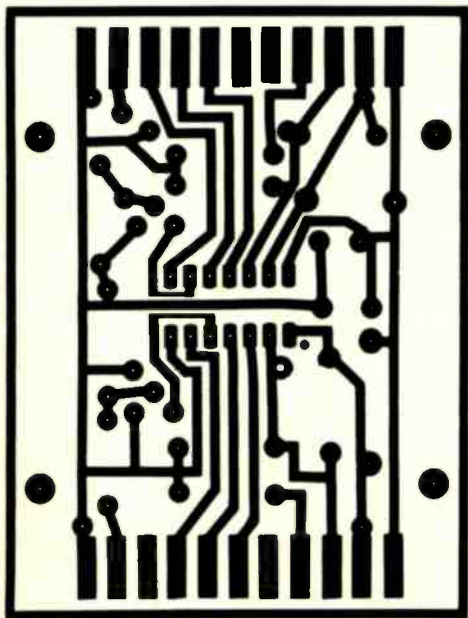
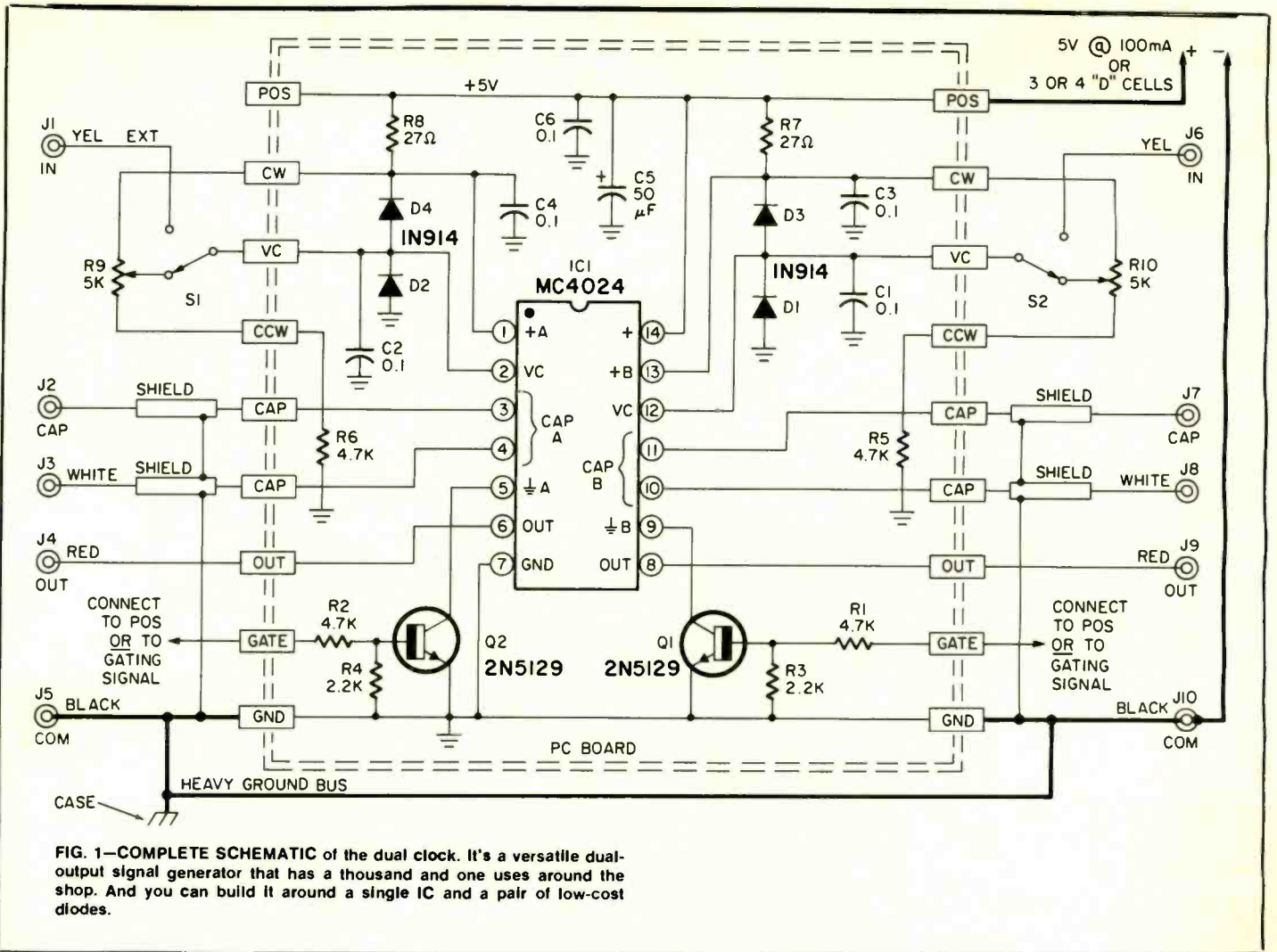

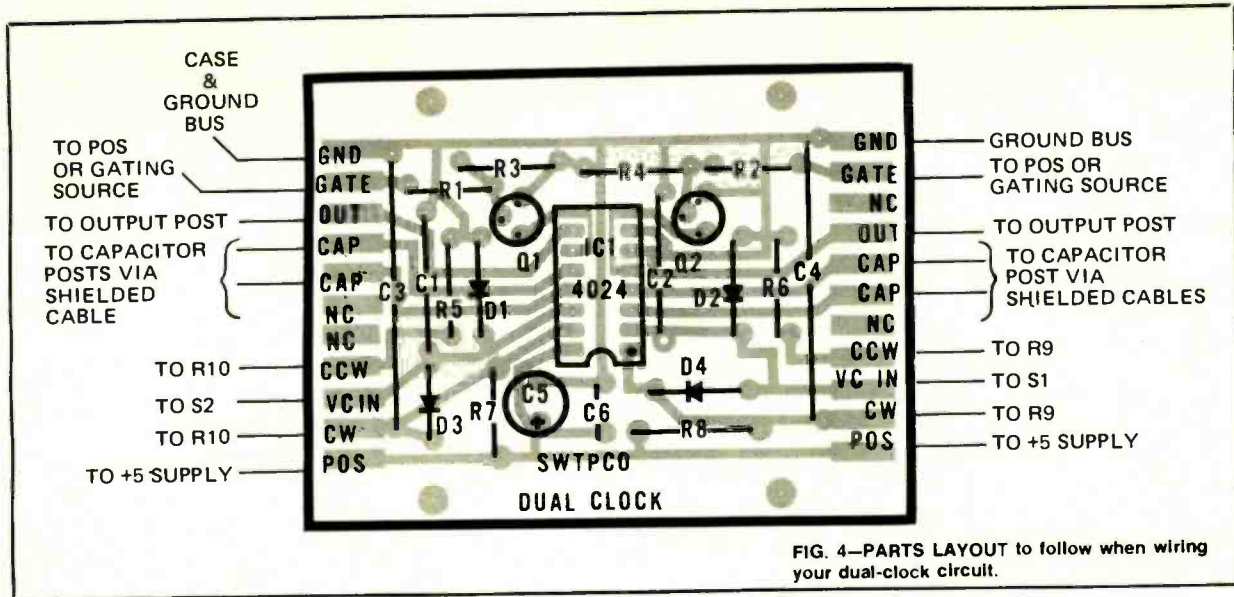

FIG. 4—PARTS LAYOUT to follow when wiring your dual-clock circuit.

R1, R2, R5, R6—4700 ohms, ¼ watt
 R3, R4—2200 ohms, ¼ watt
 R7, R8—27 ohms, ¼ watt
 R9, R10—5000 ohms, linear pot
 C1, C2, C3, C4, C6—0.1 µF, 10 volts, disc ceramic
 C5—50 µF, 6 volts, electrolytic
 D1, D2, D3, D4—1N914 silicon diode
 IC1—MC4024 or MC4324
 Q1, Q2—2N5129
 S1, S2 spdt slide switch
 J1 thru J10—5 way binding posts, 4 white, 2 each red, yellow, and black
 MISC: PC Board, 2¼" x 3"; case; mounting feet

(4); push-on knobs (2); RG-174 or other miniature shielded wire, 2 feet; hookup wire; PC board mounting hardware; ground bus; solder, ground lug to fit J5.

NOTE: The following items are available from Southwest Technical Products, 219 West Rhapsody, San Antonio, Texas, 78216:
 Integrated Circuit IC1 MC4024, \$2.40.
 Etched and Drilled PC Board No. 176B, \$1.80.
 Complete kit of all parts including prepunched and prefinished case and complete assembly instructions No. 176-C, \$8.30.

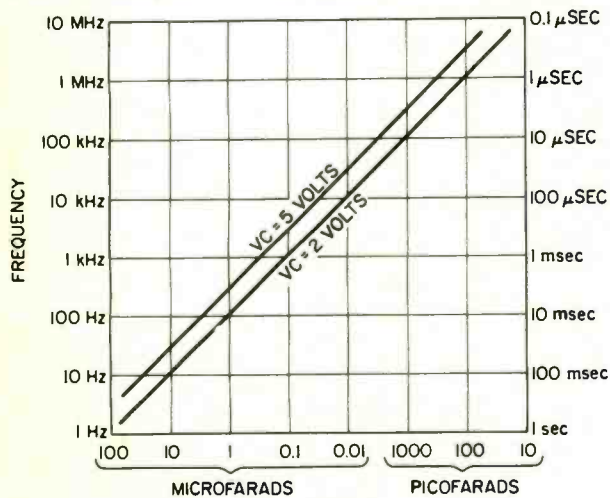

FIG. 5—OUTPUT CAPACITOR selection is simplified by using this little chart.

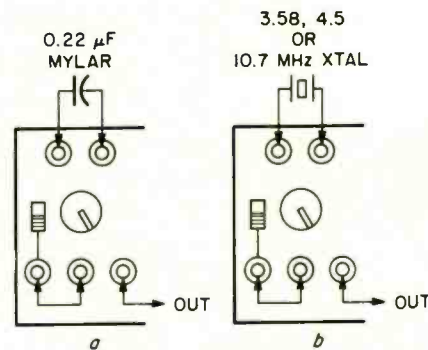

FIG. 6—FOUR APPLICATIONS for the dual clock, a—1 kHz test oscillator, b—crystal clock or marker generator, c—1 pps metronome or clock source, d—two-tone alarm.

No. 14 ground bus, made from a piece of house wiring. When lead dress is right, both oscillators should run over their entire range without any interaction, pulling, or noise problems.

If desired, a small 5-volt power supply may be added to the bottom of the case. It should be regulated if extreme frequency stability is needed.

Operation

To use one of the clocks, apply 5 volts, make the gate input positive by 2.5 to 5 volts, use the internal pot, and snap a capacitor in place. The frequency is determined by the graph of Fig. 5. For instance, a 0.1-µF Mylar capacitor should give you a range of 1200

Hz to 4500 Hz.

Some practical circuits are shown in Fig. 6. A 1-kHz square wave generator (Fig. 6-a). A 3.58, 4.5, or 10.7-MHz crystal oscillator for color, sound TV or FM work (Fig. 6-b). Crystals below 3 MHz may be used, but some capacitive padding is sometimes needed for stable operation. You can go down to 100 kHz if you custom-fit the padding to the particular crystal in use. A one pulse-per-second timer or metronome (Fig. 6-c). A two-tone audio alarm that puts out a commanding TWEEE-DELLL TWEEE-DELLL note (Fig. 6-d). To allow one clock to control the other, or anytime you want a full five volts output, add a 2,200- or a 470-ohm resistor between

the driving output and +5 volts. You might like to do this internally.

To gate one clock with the other, remove the gate input from POS and connect it to the other output. This gives you a gated oscillator or a tone burst generator. Or, add a big electrolytic and a charging resistor to the VC INPUT to get a siren or FM signal source.

There are many options available to you. If you want, bring the GATE inputs out to binding posts and add permanent output pull-up resistors. Or to cut costs, if you're never going to use an outside world signal, leave off protecting diodes D1 thru D4. You'll find lots of ways to customize this Radio-Electronics dual clock to your own uses. R-E.

ALL ABOUT ELECTROLYTICS

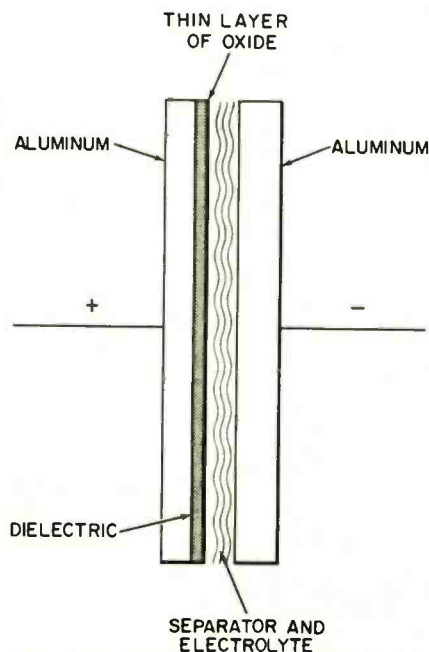

FIG. 1—ELECTROLYTIC CAPACITOR PLATES greatly enlarged. The very thin layer of oxide is the dielectric.

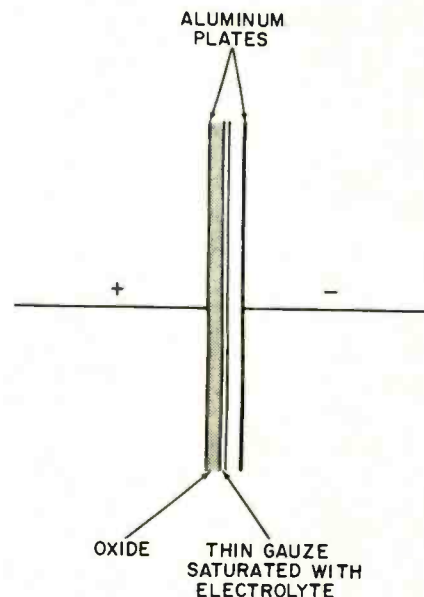

FIG. 2—BASIC CONSTRUCTION of all dry electrolytic capacitors follows this pattern. There are two sheets of aluminum foil with electrolyte between them. The sandwich is then rolled up to form the capacitor.

THE MODERN ELECTROLYTIC CAPACITOR is one of the "main parts" in electronic circuits today. Their major use is still power-supply filtering, but electrolytics are also used for bypassing and signal-coupling, especially in solid-state circuits.

They can also cause some of the weirdest troubles imaginable! So, let's take a long look at these things—how they're made, how they're used, and most important of all to the service technician and experimenter, how to test them.

We'll show you at least one guaranteed-infallible test for an electrolytic! They are not hard to test if you know how they work and how they act when they don't work.

How electrolytics are made

We don't have time to go into a detailed explanation of the design of an electrolytic capacitor. You don't have to build them—all you have to know is what size to buy and use.

All capacitors have two plates. Capacitance depends on the size of these plates, and the spacing between them, and the dielectric between them. An electrolytic capacitor is made of two sheets of aluminum. This metal has a peculiar yet useful property—it oxidizes very rapidly. Clean a piece, and without special precautions, it's covered with a thin layer of aluminum oxide before you can say Jack Robinson. Remember this oxide layer!

The original electrolytics were wet types. A corkscrew-shaped electrode was mounted in a can, filled with a solution of borax, etc. A forming voltage, dc, was applied and the oxide layer formed on the positive electrode, the corkscrew. The can was negative. The oxide layer, about 10^{-5} cm thick is the negative plate! Since it is very close to the metal, the result is a very high capacitance per sq. inch. The electrolyte liquid and the other metal plate, or the can, is used only to make electrical contact to the outside of the oxide layer (Fig. 1)!

The wet types, like all electronic components, had disadvantages and advantages. One big advantage was their ability to arc between the plates, and then heal. (The paper capacitors used during that period would not do this. When they broke down, that was it.) The disadvantage was large size. An 8- μ F wet electrolytic had a diameter of about 2.5 inches and were 3 to 4 inches high. Also, they had to be kept right-side up, to assure proper venting of the electrolytic capacitor.

Eventually, the wet electrolytic was replaced by the present dry electrolytic types. These aren't any more dry than a dry battery is. The liquid electrolyte is still used, but in a different form. To make one like this, two very thin sheets of aluminum foil (2-3 mils thick) are rolled up, with a porous separator between them. This is saturated with the electrolyte in a paste form. The roll is

sealed into aluminum cans. One end of the can has an insulator with a terminal, which is the positive plate, except in specially-built units (Fig. 2).

The first dry electrolytics used smooth foils. They got what was then an amazing amount of capacitance into a very small can. Manufacturers kept looking for ways to increase capacitance without increasing size, and they found it. The surface area of the plates determined the capacitance. So the surface of the plates was etched enough to make it rough (Fig. 3). The roughness increased the effective surface area, and the capacitance increased.

Making an electrolytic

Assembling an electrolytic capacitor is a fascinating process. Two sheets of perfectly clean aluminum foil, with the saturated separator between, are rolled up to form a cylinder. The sheets are usually offset slightly; and aluminum tabs are spot-welded to each foil for the connections (Fig. 4). This assembly is sealed into the can and the tabs are welded to the terminals.

In this condition, the thing would have a certain amount of capacitance, but it would be small and the leakage would be high. You could say that it is not a capacitor, yet.

To make an electrolytic out of it, a dc forming voltage is applied. The forming voltage determines the working voltage of the finished capacitor! The positive voltage is connected to the in-

The modern electrolytic capacitor is not the simple device it seems.
Take a look at how it is made and how it may fail.

by EUGENE CUNNINGHAM

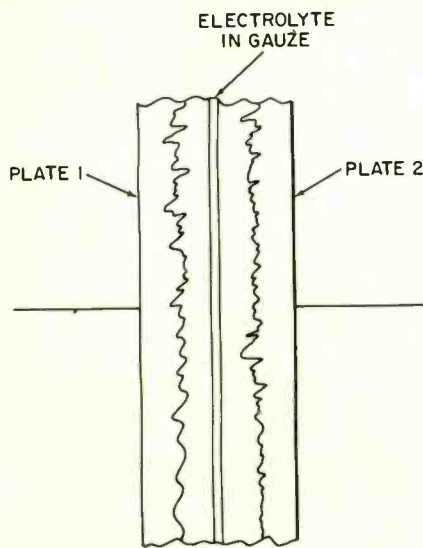

FIG. 3—ETCHING THE SURFACE of the aluminum sheets that form the plates of the "dry" electrolytic capacitor, in effect, increased the surface area of these plates. This, in turn, increases the capacitance, permitting a larger-value capacitor in the same size case. A simple but effective technique.

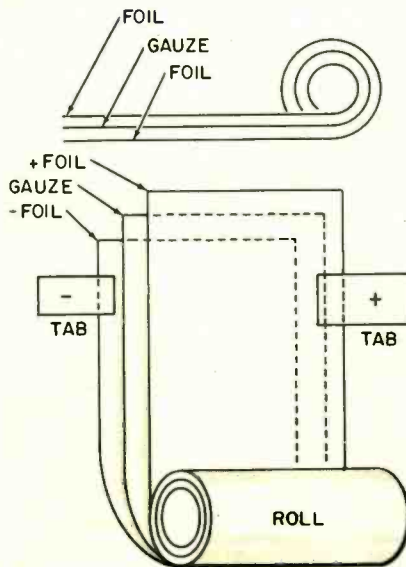

FIG. 4—TYPICAL CONSTRUCTION of a dry electrolytic. You can see how the two foils, with the electrolytic between them, are slightly offset. This simple offset makes it possible to have the connecting tabs located so they come out at opposite ends of the assembled capacitor.

insulated terminal, the + terminal of the capacitor. This causes the oxide layer to form on the positive plate. The thickness of the oxide layer determines the capacitance of the unit, also its safe working voltage. For low-voltage capacitors, a very thin layer is formed, and the capacitance is greater. (Plates spaced closer.) The oxide layer could be said to be plated on the surface of the positive plate.

These capacitors, in all standard types, are definitely polarized. The positive terminal must be connected to a positive voltage. If they are reversed, the current-flow through the electrolyte will actually dissolve the oxide layer into the electrolyte and the capacitor will conduct dc. So you can't use it backwards.

There are specially built "nonpolarized" electrolytics for use on ac. But practically all of the ones we find in electronic circuits, though, will be dc electrolytics. Unless they are a special type, the insulated terminal will always be positive and the can negative.

Remember those little tabs which make the contact; we'll be seeing them later!

Leakage current

Because of their peculiar construction, all electrolytic capacitors permit some leakage. With the proper polarity, in good grade capacitors, this is very small. We used to have a rule on this; "one tenth mill per mike". (0.1 mA/ μ F).

The new models have a leakage much lower than this. They have to! Otherwise, leakage current through a 4,000- μ F capacitor would be something like 400 mA.

Leakage current is measured by applying the rated dc working voltage to the capacitor, and reading the current on a milliammeter. Practically all of the better capacitor testers can make this test. If the applied voltage is reversed, a much greater leakage current will flow, and the capacitor will be destroyed.

You can verify this for yourself with an ohmmeter. Connect the positive lead to the + terminal, and the negative to the -. You'll see a fairly high resistance. Reverse the ohmmeter leads, and you'll see a very low resistance, even with the very low voltage applied by the ohmmeter battery. (Very much like the effect you get when checking a semiconductor diode!)

If the forward leakage current is too high, it will generate heat, inside the electrolytic. So if you find a warm or hot electrolytic in a power-supply circuit, and there is no source of heat nearby, look out! This one is probably on the verge of failing! If the leakage current is high enough, it can even cause steam to form, and the pressure will break the seal and blow off the electrolyte. Whereupon, the capacitor opens. (In some of the older wet types, steam pressure has been known to make the can explode and shoot itself through the top of the cabinet like a tiny rocket!)

High power factor

Excessive leakage is part of the cause of one of the most annoying faults in an electrolytic capacitor—high power factor. It reduces the capacitance only a little bit, but it sharply reduces the filtering efficiency. As simply as I can put it, it's about the same as connecting a good sized resistor *in series* with the capacitor.

All good capacitor testers can measure power factor. This is done with a bridge circuit. As a rough rule of thumb, units which read higher than about 15% power factor should be eyed with deep suspicion! High power-factor capacitors can cause some of those weird reactions I mentioned before. We'll get to a reliable test for this in a minute.

What are they used for?

What do we do with electrolytics? Everything. Their principal use in the early sets was power-supply filtering. However, in modern sets, especially solid-state models, you'll find them used as bypass and coupling capacitors too. We need to know what they do, how they do it, and the typical fault-reactions we see when they aren't doing it.

Power-supply filtering

In all ac-powered equipment, the basic power supply is the 117-volt ac line. This is stepped up or down to the proper voltage, rectified, and must then be filtered to a "pure dc". If you're Brit-

ALL ABOUT ELECTROLYTICS

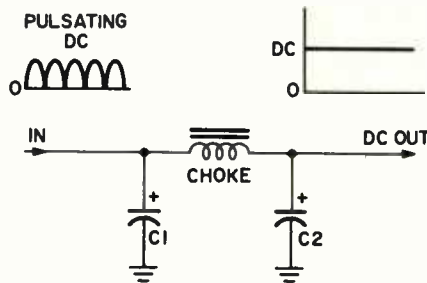

FIG. 5—FILTER CIRCUIT for removing the ripple (ac component) from pulsating dc from the rectifier output.

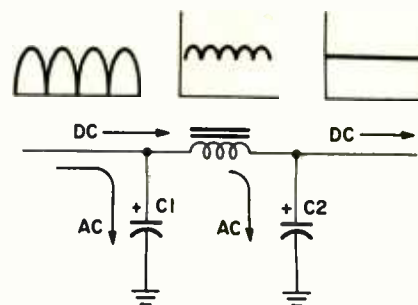

FIG. 6—AC GOES TO GROUND through the filter capacitors. Dc goes on through the circuit.

ish, this is “smoothing”. The basic circuit used in practically all filters is in Fig. 5. It works because of the useful property of a capacitor to pass ac and block dc.

The rectifier output of all power supplies includes ripple. This is the sinewaves of ac that we fed to the rectifier—actually a “pulsating dc” as in Fig. 5. If we think of this as “dc with an ac component” it may be easier. Our filter circuit works something like the diagram of Fig. 6.

The ac component is passed to ground, through the first and second filter capacitors, while the dc component goes on through the choke. We come out of the filter with fairly good dc.

This is a “ π -section filter”—so named because it looks like the Greek letter π . Here, C1 is the input filter and C2 the output filter. Remember these names. They’ll come up later on. Each one has a different fault-reaction to help us find the trouble.

Dc power supply troubles

Rule one: The *one circuit* in a set that is *common* to *all* of the others is the dc power supply. Any faults in it will show up in *all stages*.

Here’s the second one: The *resistance* of the dc power supply, as measured to ground with an ohmmeter, must be *very high*. The *impedance* of the dc power supply must be *absolutely zero*, or very close to it.

If the dc resistance is too low, the circuit draws too much leakage current, and the transformer gets hot, the rectifiers blow, etc. This kind of problem can usually be solved with an ohmmeter, and/or a voltmeter. Low resistance here is usually caused by shorted or leaky electrolytic or paper capacitors. To find the cause, look for the last resistor in the string that’s too hot, and then find the shorted capacitor on the load side of it!

How do we make the impedance of the dc power supply so low? With big electrolytic capacitors connected from the dc supply lines directly to a common ground. All of these capacitors can be considered as being connected in

parallel across the dc supply lines. So their capacitances add. Four 80- μ F capacitors gives us a total of 320 μ F.

Why is this such a big deal? We need pure dc for the power supply, of course, but this is not the only important function of these capacitors. They are also bypasses. Here’s a very important fact: remember it. *The dc power supply acts as a common ground-return for every signal-handling stage in the set!* (See Fig. 7).

The dc power supply is fed up the lines to operate the amplifiers. In all amplifiers, the signal is developed across a “load impedance”. After the signal has passed through this impedance, and done its work, we have to get rid of it! It must be bypassed quickly to ground.

Since the only way we can do this is to bypass it to ground through a big capacitor, here’s where those big electrolytics in the dc power supply come in handy. As you can see in Fig. 7, the total impedance of the power supply to ground, at all frequencies from 60 Hz on up, must be as close to absolutely zero as we can make it. Signal-return currents from every stage in the set flow through it; 60/120-Hz ripple, 60-Hz vertical sweep, 15,750-Hz horizontal sweep, video, audio, color, etc. You name it, we’ve got it in there somewhere.

If you have zero impedance to ground, no matter how many currents you have flowing through it, you won’t develop very much voltage drop across it. And that’s what we must have.

What would happen if we *didn’t*? What if we had what some of the books call *non-zero impedance to ground*? In other words, one of our electrolytic capacitors has opened, or lost capacitance, and as a result, the impedance of our dc power supply is now greater than zero. Now we have some resistance in our return circuit. In Fig. 7, we had zero, so we had zero voltage drop across it. Now we have something like Fig. 8. We have a resistance in series with our signal currents and we do have a voltage drop across it.

Now we’ve got signals of all kinds flowing *back and forth* on our dc power supply lines. Since the dc power supply is common to all stages, some of these are going to be fed back into other stages. What does feedback cause, with the right phase? Yes sir! Oscillation. (Incidentally, it can also modulate the other signal.)

Notice that we didn’t even bother to label each stage in Fig. 8. It makes no difference at all which stage is feeding back into which! In all cases, this causes trouble (and that starts with “T” and rhymes with “E” and that stands for *electrolytics!*) I can make a firm statement here; counting all the cases of this type of trouble that I have ever run into, at least 99% of them have been caused by faulty electrolytics.

Fortunately, there are several ways to pin down this problem. One requires only the well-calibrated eyeball, and the other calls for an instrument that should be used in all service shops. This one gives you an infallible test for this. We’ll get to them very soon.

Symptom analysis

Right now let’s warm up by talking about one of the most important things in all kinds of electronics repair work—the analysis. Diagnosing the cause of a fault is the hard part. The actual repair takes very little time. So if you learn to recognize the usually obvious symptoms of electrolytic capacitor faults, it can speed your work tremendously.

The failure of an electrolytic capacitor in any kind of circuit will give you a definite indication. If it’s shorted, this is easy. Up the ohmmeter and at ’em. In the simple half-wave or full-wave power supply, an open capacitor in the filter input will make the dc voltage drop to about ½ of its normal value or less (C1 in Fig. 6).

So if we find the dc supply voltage is low, and the rectifiers, etc. all in good shape, and no obvious overloads or hot resistors, etc.—the first thing to look for is an open input filter capacitor. You can check for it by simply bridging a good capacitor across the input filter. If

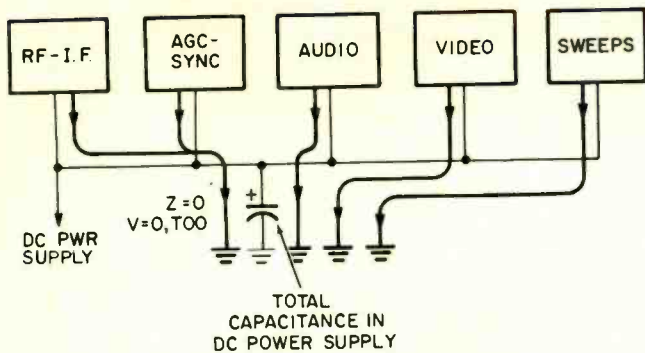

FIG. 7—DC POWER SUPPLY circuit for any set. This also acts as signal-return path for all stages.

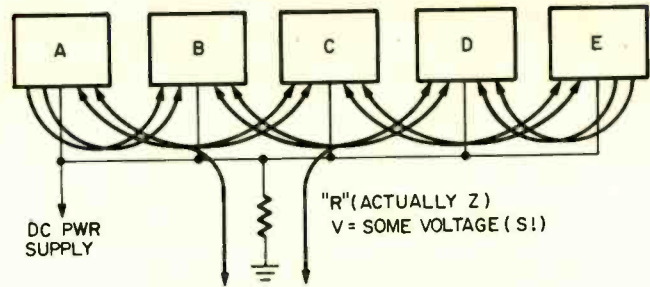

FIG. 8—SAME SIGNAL-RETURN path as in Fig. 7, but now we have non-zero-impedance, and look at that mess of feedback paths.

the dc voltage jumps back to normal, you've found the trouble. Needless to say, this applies to *tube circuits only*. Don't do this in transistor circuits with power on. The resulting surge can damage transistors.

Audio problems

In all audio amplifiers oscillation is a common symptom of electrolytic failure. It is usually caused by a unit that has opened or developed a high power factor. As a result, there is a feedback path through the power supply, and away we go. This kind of oscillation can be anything from a high-pitched squeal to a very low-frequency plop, plop sound, which used to be called motor-boating.

Once again, an open capacitor is at fault, so you can bridge a good one across any suspected unit and see if it stops the trouble. Remember, only in tube sets with the power on. Turn the power off in solid-state sets before bridging and back on only with the bridge capacitor in place. Follow the same power-off procedure to remove the bridge capacitor.

By the way, this kind of trouble can develop even in battery-powered amplifiers, radios, etc. The basic cause is the same; non-zero impedance to ground in the power supply. You'll find a good-sized electrolytic capacitor connected across the dc supply lines to hold this impedance to the lowest possible level. Same basic symptoms; oscillation, etc. A weak battery can cause similar symptoms so check the battery in battery-powered sets first.

Black & white TV set troubles

You can have the same kind of power-supply troubles in black & white TV's. Dc voltages low, oscillation in audio, and so on. Now you can see some of the symptoms, though. In sets with a full-wave rectifier, an open input filter capacitor can allow the ripple to reach high levels, and reduce the dc voltage as well. So you get a symptom looking something like Fig. 9.

Note the BASIC CHARACTER-

ISTICS: raster reduced in width; two dark "hum-bars" showing on the raster, and the edges of the raster pulled in. You see two hum-bars because the basic ripple frequency in full-wave dc supplies is 120 Hz, and the vertical sweep is 60 Hz. If this set had a half-wave rectifier in the dc supply, the ripple frequency would be 60 Hz, and you'd see only one hum-bar.

This is one of the very few places where you can be led up the garden path by the symptoms. A heater-cathode short in any tube with a cathode resistor can cause the same single-hum-bar symptom. Even the rf amplifier can do it. (Our infallible tester will catch this; wait just a minute!)

All TV sets

Remember the multiple feedback paths shown in Fig. 8? Here is our MVS (Most Valuable Symptom). Any fault in this common-ground-return path will cause multiple symptoms. So if you see any TV set with several different symptoms all at the same time, look for a bad filter capacitor! Almost certainly open, or high power-factor.

Why is this? Because, by the nature of things, other part-failures in TV circuits will affect only one thing; video, audio, sweep, etc. Dead tube, open resistor, shorted paper capacitor, etc. Sets which have multiple symptoms are almost certain to have a common cause, and here we are again; the dc power supply and its electrolytics.

This does not refer to something like a "no raster" complaint, that could be a shorted rectifier, fuse, etc. If you do

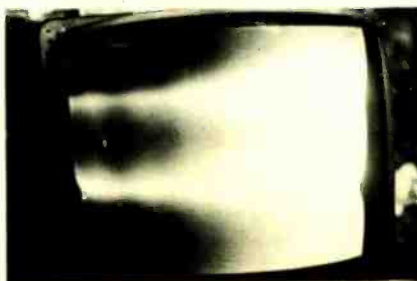

FIG. 9—DOUBLE HUM BARS, bending of edges of raster, narrow raster—all symptoms of electrolytic capacitor trouble.

have a raster, but (for a typical example) you have very poor horizontal and vertical sync, bending, shading of the picture, smeared color, oscillations visible in the picture, and so on, go straight for the dc power supply and start checking electrolytics. Dc voltages in these cases will offer very little help. You need the Infallible Test Instrument; I told you we'd get to it.

The Infallible Test Instrument

The best test for any kind of electronic equipment is actual operation in the circuit where it's supposed to work. If we can get an accurate reading on how well the thing is working, without having to take it out for an external test, this is far more useful (and a heck of a lot faster). The capacitor-tester is very useful, necessary, and you should have one. There will be times when you need it, for reading leakage, capacitance, power-factor, etc.

However, you have one instrument on your bench that is a simple, fast, and *absolutely infallible indicator* of this kind of trouble. It is the oscilloscope. With one quick jab of the probe, you can tell whether any electrolytic capacitor is doing what it's supposed to—in-circuit and in operation.

How-come? What? Well, go back a few paragraphs, and see what I said about what an electrolytic capacitor is supposed to do. It is supposed to *remove all signals* from the dc power supply lines. So to find out if it is doing the job, just touch the scope-probe to the terminal of any electrolytic capacitor: if you see anything, there's a bad (open) capacitor in there! The scope responds only to ac signals! (In this case: you can use a dc scope, but put a blocking capacitor in series, making it an ac scope).

If we see any ac floating around on the dc supply lines, we have trouble. The impedance of the power supply should be so low that you should *never* be able to see any signal; just a nice straight line. You do not have to calibrate the scope, or set the sweep to any particular frequency! Just set the verti-

(continued on page 84)

R-E's Service Clinic

practice what I preach!

Keep your scope handy, use it wisely. It's a friend that will never let you down

JACK DARR
SERVICE EDITOR

AT REGULAR INTERVALS I EMBARRASS myself by NOT doing what I keep telling others to do! A really good example of "Don't do as I do, do as I say!" There is one redeeming feature, though. I get to write up my mistakes and sell 'em, much to the envy of some friends. Herewith, the history of one of these.

The victim was an RCA CTC-38 color set. It had some dandy symptoms (all intermittent, of course): Horizontal pull, loss of sync, color smear, and a few more. It was brought in by a friend who had been working on it for a couple of days. He claimed that it acted up at home, but sat on his bench and played perfectly. (Normal, huh?) So, we set it up, hooked it to the test jig, and started in.

He was right; it did play very well. Voltage checks showed nothing unusual; the agc tube plate showed a normal reaction with and without signal. However, the agc control showed a rather odd effect. Instead of going smoothly from whiteout to blackout, it had a sort of "hump in the middle" kind of action. Agc voltages seemed to be very close. I tried to override the agc voltage with my bias box, without success. Checking the schematic showed why: my old box went only to 20 volts, and this one needed considerably more than that. So, "Oh, well. We'll do without it." (Mistake No. 1.)

At about this point in the proceedings, I accidentally found that the thing was *mechanically* intermittent. You could push on the bottom of the PC board, at certain places, and make the symptoms appear and disappear. Oh, ho! This is going to be easy. Cold solder joint. After about 15 to 20 minutes of pushing, tapping, bending and hammering on it, I decided that it was not going to be all that easy. Everything I *touched* made it cut in and out!

A close visual examination of the bottom of the PC board showed no obvious bad solder joints. So, I got down the shotgun; I resoldered all of the joints in the area that seemed to be the most sensitive. This helped—just as much as anything I'd done so far—or, not at all.

Quite a few fruitless voltage measurements and hammer-tests later, I fi-

nally did what I should have, long before this. I got out the scope. Nothing in the way of excess ripple on the dc voltage supply lines; symptoms in or out. Keying pulse on agc tube plate clean, plenty of amplitude. So, there went that one. Signal on agc tube grid, woops! Here's something that isn't right! All bent up and badly distorted.

Back to the video detector output; signal there OK when board was pushed down, very badly distorted when board pushed up to make the symptom show up. Ah, ha! This trouble is NOT in the sync, etc. where I'd been looking for it. It's farther back, in the i.f. or tuner. (At this point, I am now beginning to show signs of having a normal mentality.)

Changing to the crystal-detector probe, I followed the signal back through the i.f., to the 1st i.f. input.

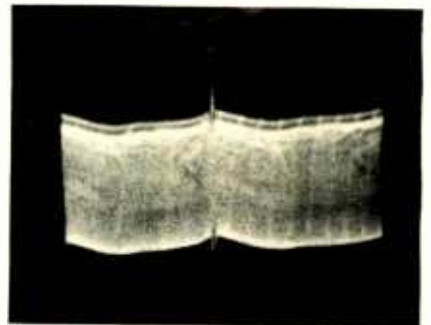

Hmm. Signal clean at that point, distorted when board pushed. Tuner trouble? No. Oh, oh. What *controls* the i.f.? The agc. So, how about the agc line? (Right at this point, I'm looking pretty good. About time, too!)

Going back to the low-cap probe, I scoped the agc line. Oh, wow! With the symptoms out, clean. With the symptom in, the dangedest mess of stuff you *ever* saw. The scope photo shows what *this* pattern looked like. This is just a *little* out of the ordinary! The agc line should have nothing but pure dc on it. Not this mess of horizontal and vertical pulses, at about 5.0 volts p-p.

After I stopped hitting myself on the head with the rubber hammer kept on the bench for this purpose the real nature of the trouble dawned on me. There are all sorts of pulses and things

This column is for your service problems—TV, radio, audio or general and industrial electronics. We answer all questions individually by mail, free of charge, and the more interesting ones will be printed here.

If you're really stuck, write us. We'll do our best to help you. Don't forget to enclose a stamped, self-addressed envelope. Write: Service Editor, Radio-Electronics, 200 Park Ave. South, New York 10003.

THIS IS WHAT THE BRAIN found on the agc line, when it went looking for it! 5.0 volts p-p of assorted mess, on the i.f. agc!

on the agc line, at its "beginning". What parts are used to take them out? Bypass capacitors. (Boy! How complicated can you get?) What would happen if one of these bypass capacitors was open? I'd have exactly the same kind of mess on the agc line that I had just seen. Ergo, the intermittent that I had been fruitlessly chasing for so long was now identified. It was one of the three agc bypass capacitors. Had to be. (Now, you're beginning to think.)

Locating these capacitors, and checking them carefully showed that C251, a .001- μ F capacitor directly connected to the emitter of the agc transistor, had a **VERY** bad ground connection. This joint just happened to be under a couple of wires on the bottom of the PC board, and I hadn't seen it. When it opened, being right on the agc input to the i.f., it allowed all of those pulses to be applied to the i.f. bases. There, they caused the mother and father of all feedbacks, and I got all of those different symptoms at the same time.

The moral of this is very simple. When I stopped using my muscles—pushing and hammering on the board, and began using my head—to make a logical *analysis* of the symptoms, I could trace the fault back through the circuits to the point where it *began*. Then, everything cleared up in a hurry! Total elapsed time, using second method, not more than 10 minutes; time wasted using first method, about two hours.

So, **STOP** and **THINK**. You **KNOW** how these things work, and "what causes certain reactions". If you'll make a few logical tests, and then interpret the results correctly, you'll get along a lot better, and be embarrassed much less frequently! **R-E**

Reader Questions

NOT ENOUGH HIGH-VOLTAGE

I've problems with a Zenith 25NC38. The high-voltage rectifier tube gets red hot and I can only read about 9-10 kV of high voltage. After some fiddling around, I pulled the cap off the 6BK4 high-voltage regulator; the high voltage shot up to 30 kV, and the high-voltage rectifier tube cooled off.

Voltage on grid and cathode of the 6BK4 reads +290 volts. Boost voltage reads +600 volts. I've checked everything I can think of in the 6BK4 circuit, no results. Where is it?—J.L., Elizabeth, N.J.

You're there, keep looking! The fact that you can get up to 30 kV with

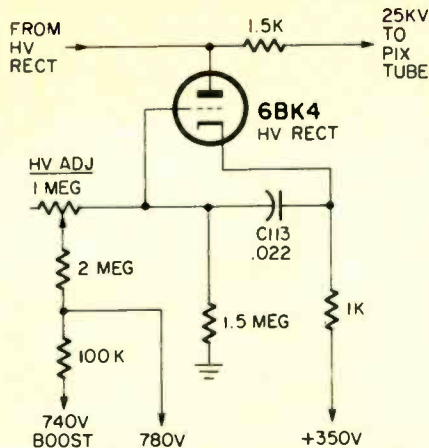

the regulator tube out of the circuit, and only 10 kV with it in proves one thing. That regulator tube is drawing a heck of a lot more current than it's supposed to. (It doesn't take much, either, with a plate voltage of 25,000 volts. Check the *maximum* rated current of a 6BK4 in the tube manual. It's a whopping big 1.5 mA!)

You have the key voltage reading—you said that *both* grid and cathode of the 6BK4 were at +290 volts. If you read this from cathode to grid, you'd notice that the tube actually has *zero-bias* on it! Same voltage on grid and cathode. Going back to the tube-man-
(continued on page 68)

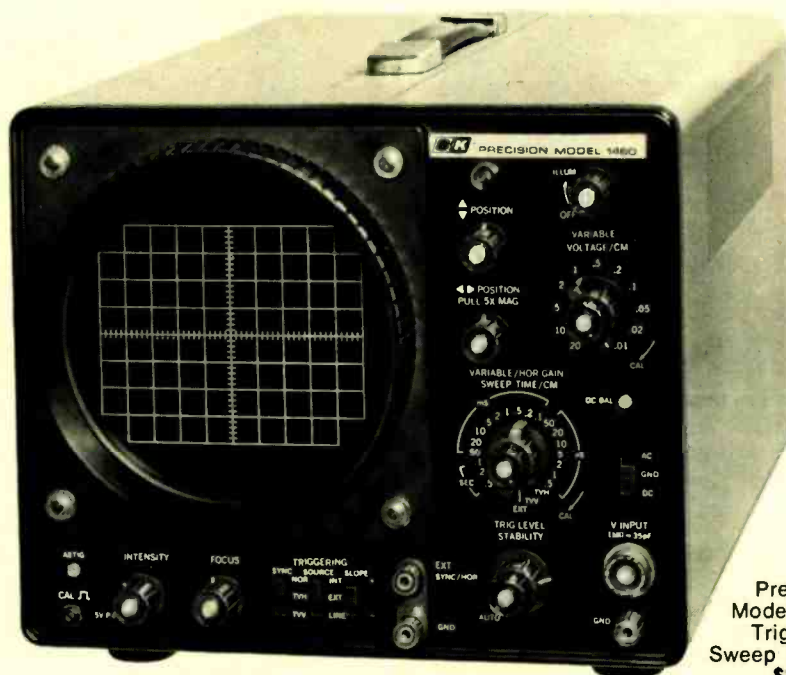

B&K
Precision
Model 1460
Triggered
Sweep Scope
\$399.95

B & K Precision's new 1460 Triggered Sweep Scope... The one that's been worth waiting for.

You won't believe how easy it is to sync TV-V and TV-H signals until you've actually tried it.

Trouble shooting complex TV circuits takes enough time without having to fiddle with dials and controls to adjust to the proper wave form.

That's why the new B&K Triggered Sweep Scope features the TV-H and TV-V positions. These are the two new positions you've always needed for quick one-knob selection of horizontal or vertical TV signals. Exclusive sync separator circuit. No complicated and time-consuming adjustments... just flick a single knob.

Fully automatic triggered sweep lets you view the entire complex TV signal or any part of it. Including the VITS (vertical interval test signal).

And the "back porch" of the horizontal sync pulse, with color burst information. All locked in rock steady.

All solid state with 6 FETS. Runs coolest. Vertical sensitivity (10mV/cm) and writing speed of 0.1 microsecond/cm (using 5X multiplier). Features usually found in expensive lab scopes. Complete with direct/10 to 1 probe. 19 sweep speeds and 11 voltage calibrated ranges, DC to 10 MHz.

Pinpoint your problems quickly and accurately with the new 1460 Triggered Sweep Scope. The only thing you'll have to adjust to is having more time on your hands. Ask your distributor or write for our free catalog.

There is a difference in test equipment—ours works!



Product of DYNASCAN CORPORATION

1801 W. Belle Plaine / Chicago, Illinois 60613

Circle 15 on reader service card

FEBRUARY 1972 • RADIO-ELECTRONICS

Does your mother-in-



law call you a meatball?

Does your boss?

Maybe even your wife? On payday.

Know what? If you have read this far, you are not meatball material. Because meatballs don't face the present, the future, the facts. They stay put. Dreaming and talking. And today, more than ever staying put means falling behind. Pretty tragic in a time when people with specific aptitudes are so necessary in so many interesting fields.

Today huge industries depend on people with electronics training.

Today there is a course of action that may lead you toward these well-paying, vital positions. It is RCA Institutes.

RCA Institutes is not for meatballs. RCA Institutes trains you for the fields where the action is: Computers • Color TV • Automation • Communications • Industrial Electronics • And more.

RCA Institutes not only has years of experience, it has an exclusive line-up of tested methods:

1. Hands-On Training

Over 250 interesting experiments. As many as 22 kits with some of the programs.

2. RCA Autotext

The easy-way-to-learn method that gets you started easier, faster.

3. Wide choice of courses and programs

Training in electronics fundamentals right up to solid state technology and communications electronics.

4. Low-Cost Tuition Plans

You'll find the one just made to fit your own budget.

5. FCC License Training Money-Back Agreement

RCA Institutes' money-back agreement assures you of your money back if you fail to pass the FCC examination taken within six months after completing RCA Institutes' FCC course.

RCA Institutes gets your training started even if you've not had previous experience or training. Just bring us your interest.

Set your own pace depending on your schedule.

If you like to tinker, fiddle, fix, put that ability to work to do a real repair job on your future now.

Don't wait. Get complete information right now. No obligation. Except to yourself. Send us the attached postcard. Or return the coupon.

Veterans: Train under GI Bill. Accredited Member National Home Study Council. RCA Institutes, Inc. is licensed by—and its courses of study and instruction facilities approved by—the N.Y. State Education Department.

RCA Institutes

Home Study Department 758-202-0
320 W. 31 Street, New York, N.Y. 10001

Please rush me FREE illustrated electronics career catalog. I understand that I am under no obligation.

NAME _____

ADDRESS _____

CITY _____ STATE _____ ZIP _____

Veterans check here

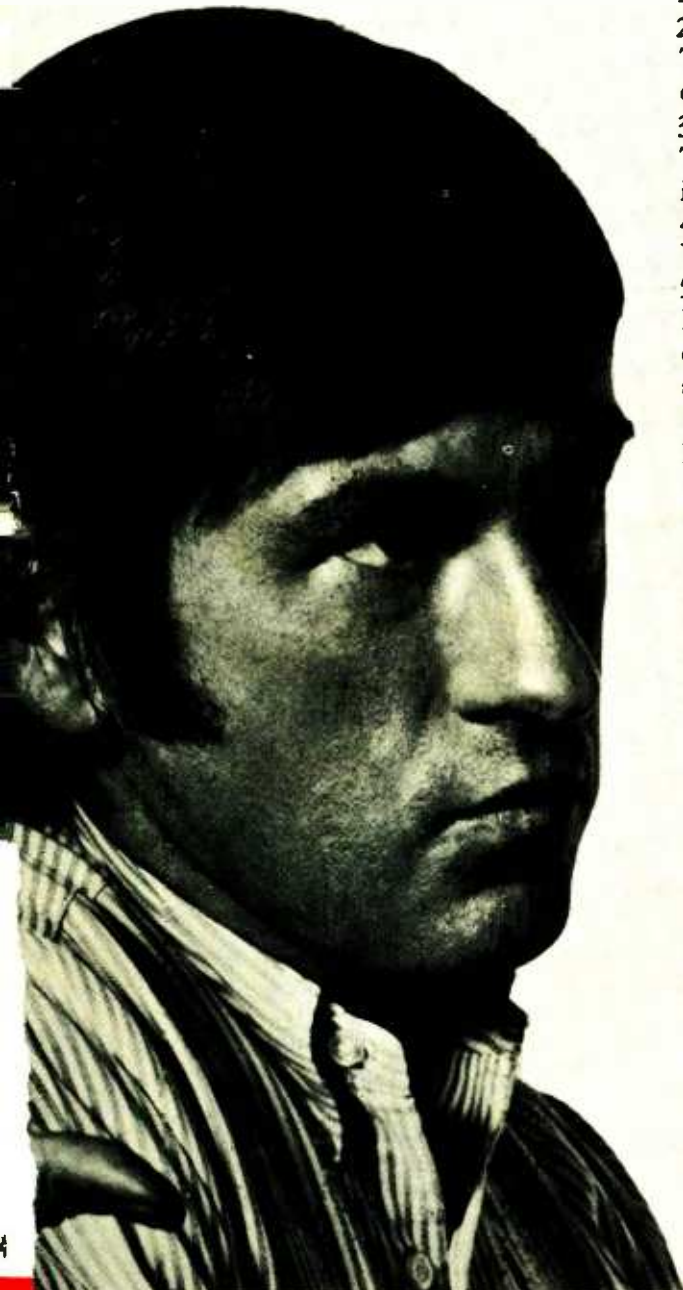

READER QUESTION

(continued from page 63)

ual again, at zero bias, the tube draws a fat 2.8 mA, or more than double the maximum rated plate current.

Normal bias on this tube must be about -15 volts. This holds the current down to not more than 1.0 mA. In actual operation, this is set by the two resistors in the grid circuit, 1.0 megohm variable (HV ADJUST) and the fixed 1.5 megohm to ground. This goes back to the boost voltage through a 2-megohm resistor. The cathode is fixed at B+ voltage through the 1000-ohm resistor to the damper plate.

Normal operation should be at about a -15 volts, or less than 1.0 mA current with the pix tube screen dark. Check these resistors. One of them may be off; or C113, the .022µF may be shorted.

RASTER RIPPLE, RAINBOW BARS

I've a bad 120-Hz ripple in the raster of this Motorola 918 color chassis. Two horizontal bars, about an inch wide, roll slowly up through the picture. At the point where the bar is at any moment, there's a color rainbow! Follows the bar up. The sides of the raster pull in and wrinkle, and this too follows the bars.

The silly part is that it does not do this on my test jig! All filter capacitors,

which I suspected at first, check perfectly good and the picture is clear; no ripple at all. I smell a resistor burning somewhere, but I haven't found it yet.—R.G., Cove, Ark.

When you took the chassis out of the cabinet, you "moved" everything

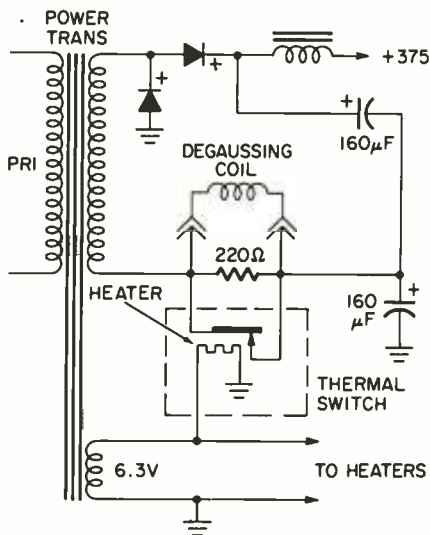

that could normally cause this, with one exception. The degaussing coil. I'm pretty sure that you'll find the thermal switch either open or burned up so that it doesn't make contact (See diagram).

In normal operation this switch is

open at turn-on leaving the degaussing coil in the circuit. It is a tiny thermal switch with a heating element in the filament circuit. It should close after a short time, shorting the degausser. If it doesn't, the coil is left in-circuit, and is carrying a hefty ripple pulse and quite a bit of dc. It is causing the 120-Hz bars and the rainbows.

There is a 220-ohm 2-watt resistor connected across the degaussing coil. It is on the front of the chassis at the degaussing coil plug. If the set is operated with the degaussing coil unplugged, the B+ circuit is completed through this resistor, which should be shorted by the thermal switch. If the switch is open, the resistor carries all the current and burns up. That's the one you're smelling. Replace the thermal switch and check the coil. It may have been heated up and shorted.

REPLACEMENT SWITCH

The on-off switch on this RCA KCS-160 is damaged. I'd like to replace it with one of the push-pull types. Don't find a listing for a replacement.—J.F., Media, Pa.

This is a special, dual switch (see diagram). S1 is the regular on-off switch in the ac input. However, S2 is a completely separate switch. It is connected to the ungrounded end of the brightness control and to a +110-volt dc source at

INTERNATIONAL
Frequency meter FM-2400CH



The FM-2400CH provides an accurate frequency standard for testing and adjustment of mobile transmitters and receivers at predetermined frequencies.

The FM-2400CH with its extended range covers 25 to 1000 MHz. The frequencies can be those of the radio frequency channels of operation and/or the intermediate frequencies of the receiver between 5 MHz and 40 MHz.

Frequency Stability: ± .0005% from +50° to +104°F.

Frequency stability with built-in thermometer and temperature corrected charts: ± .00025% from +25° to +125° (.000125% special 450 MHz crystals available).

Self-contained in small portable case. Complete solid state circuitry. Rechargeable batteries.

WRITE FOR CATALOG!

- Tests Predetermined Frequencies 25 to 1000 MHz
- Extended Range Covers 950 MHz Band
- Pin Diode Attenuator for Full Range Coverage as Signal Generator
- Measures FM Deviation



FM-2400CH (meter only).....	\$595.00
RF crystals (with temperature correction)	24.00 ea.
RF crystals (less temperature correction)	18.00 ea.
IF crystals.....	catalog price

INTERNATIONAL
CRYSTAL MFG. CO., INC.
10 NO LEE • OKLA. CITY, OKLA. 73102

the 22JF6 screen grid.

This is a "spot-killer" switch; it turns on when the ac line switch is turned off. This puts the +110 volts dc on the brightness control and the picture tube cathode, thus discharging the hv quickly and killing the spot.

As far as I know, no one makes an

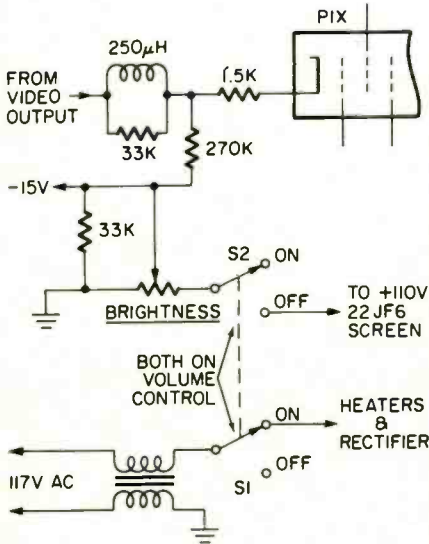

exact duplicate. RCA part number is 119191. In an emergency, you can use any stock 1-megohm volume control with an spst switch and leave the spot-killer circuit open. With an aluminized picture tube it doesn't do much good anyhow!

APPLIANCE CLINIC

(continued from page 24)

an open. If C1 is shorted, you won't be able to get enough gate voltage on the trigger diode. So, the thing would stay off at all times. If C1 was open or leaky, the chances are that it would either refuse to work or operate erratically. If either the trigger diode or the Triac shorts, the light will stay on all the time. (I'm not sure, but I believe that a shorted trigger diode would destroy the Triac, from breakdown due to excessive gate voltage. Depends on the resistance "after the short.")

The photocell causes little trouble: if you suspect it, check it with an ohmmeter. Dark, it should have a very high resistance. Shine a flashlight on it and the resistance should go away down. If it'll do this, it's OK.

This particular Triac and several others in the same series are built in a TO-5 transistor case. Looks like a transistor but isn't. Check the number in any good Transistor Guide to make sure.

JACK DARR
SERVICE EDITOR

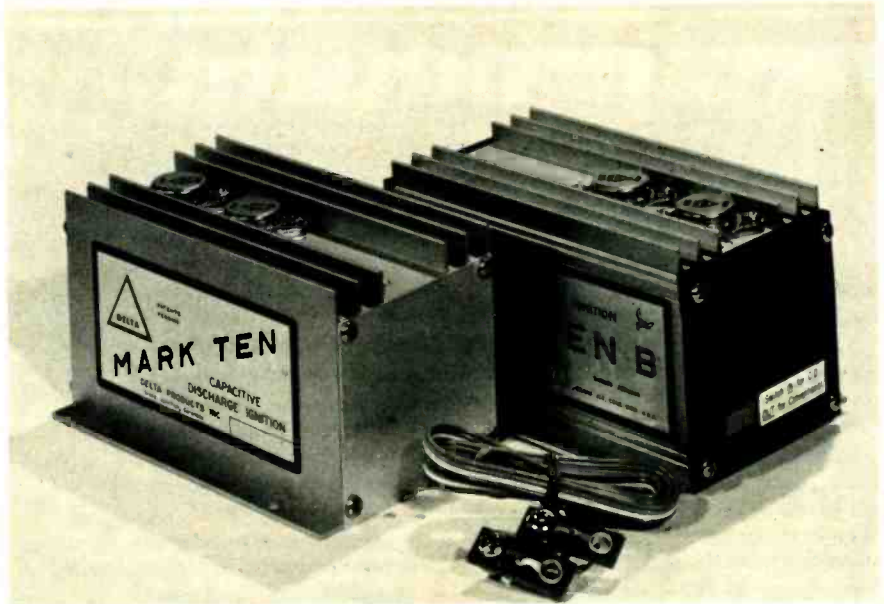

Save money and improve car performance at the same time.

Maintenance costs go down and performance increases when you put a Delta Mark Ten Capacitive Discharge Ignition System on your car.

For eight years we've been telling you about the tremendous advantages of CDI systems. We've promised and delivered better performance for cars, boats and trucks. Hundreds of thousands of satisfied customers testify to that fact. However during these eight years, we've been asked over and over again, "If CDI systems are so great, why doesn't Detroit adopt them?" It's taken a long time, but finally Detroit has recognized the value of the CDI system. Chrysler, long noted for excellence in engineering, is now installing CDIs in new cars. Have you seen their ads? Heard their commercials? They're repeating what we've said for eight years. *CDI systems not only improve performance, but eliminate the need for most tune-ups.* If you're not buying a new car, but want new car performance, put a Mark Ten or Mark Ten B on your present automobile. If you're purchasing a new car with no CDI system, install a Mark Ten or Mark Ten B and enjoy the benefits of low maintenance and increased performance.

HERE'S WHAT A MARK TEN WILL DO FOR YOU:

Mark Ten and Mark Ten B – up to 20% increase in gasoline mileage
 Eliminates 3 out of 4 tune-ups Installs in only 10 minutes Spark plugs last 3 to 10 times longer Dramatic increase in performance Promotes more complete combustion Instant starts in all weather.

Mark Ten B—Improves combustion, reducing contaminants Handy switch with redundant contacts for instant return to standard ignition Applicable to ANY 12 volt negative ground engine Eliminates starting and idle problems Longer spark duration during cranking and idling.

Mark Ten (Assembled) \$44.95

ppd

Mark Ten (Deltakit) \$29.95

ppd

Kit available in 12 volt only,
positive or negative ground

Mark Ten B \$59.95 ppd

(12 volt negative ground only)

ORDER TODAY!

Superior Products at Sensible Prices



DELTA PRODUCTS, INC.

P.O. Box 1147 / Grand Junction, Colo. 81501
(303) 242-9000

Please send me literature immediately:

Enclosed is \$ _____ Ship ppd. Ship C.O.D.

Please send:

___ Mark Ten B @ \$59.95

___ Standard Mark Ten (Assembled) @ \$44.95

___ 6 Volt: Neg. Ground Only ___ Positive Ground

___ 12 Volt: Specify ___ Negative Ground

___ Standard Mark Ten (Deltakit) @ \$29.95
(12 Volt Positive Or Negative Ground Only)

Car Year _____ Make _____

Name _____

Address _____

City/State _____ Zip _____

Circle 17 on reader service card

new products

More information on new products is available from the manufacturers of items identified by a Reader Service number. Use the Reader Service Card on page 101 and circle the numbers of the new products on which you would like further information. Detach and mail the postage-paid card.

BURGLAR ALARM SYSTEM, Watchdog, do-it-yourself kit. Low-cost system is easy to install. Comes with eight-inch diameter bell that is activated by solid-state control circuitry. Three sets of magnetic weather-proof switches, on-off key switch, door cord, wood screws, 100 feet of plastic-



coated wire and illustrated installation drawing are included. Designed to sound local audible alarm to scare off intruders, the system is powered by 12-volt dc battery. \$49.95.—**Crime Detection Systems, Inc.**, P.O. Box 790, Dept. A-89, Pearland, Texas 77581.

Circle 31 on reader service card

MAGNETIC TAPES, UD-C-60, UD-C-90. Blank cassette tapes in sixty- and ninety-minute lengths. Feature wide dynamic range, high output, low-noise characteristics. These are ferric-oxide coated tapes



that are intended to be used in existing cassette recorders without any need for readjusting the bias setting.—**Maxell Corp. of America**, 501 Fifth Ave., New York, N.Y. 10017.

Circle 32 on reader service card

TRANSISTOR SOCKET for new 8 lead TO-3 case. Molded nylon top wafer with two integral .060 high insulating shoulder

mountings. Eight spring brass cadmium plated pin contacts and two steel cadmium plated mounting lugs with 6-20

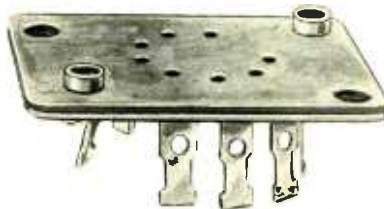

formed threads that will accept a No. 6 metal tapping screw.—**Keystone Electronics Corp.**, 49 Bleecker St., New York, N.Y. 10012.

Circle 33 on reader service card

AUDIO AMPLIFIERS, Sanken Series S-1000A. A 50-watt hybrid IC for audio amplifier applications. Delivers 50 watts into an 8-ohm load. Harmonic distortion is 0.5%. An application note showing how to



use the hybrid IC to build a stereo amplifier is available.—**Airpax Electronics, Int'l. Div.**, P.O. Box 8488, Fort Lauderdale, Fla. 33310.

Circle 34 on reader service card

SPEAKER SYSTEM, LST, designed specifically for professional applications as a broadcast and recording monitor or on a medium-power sound reinforcement system requiring maximum accuracy. Offers six different energy profiles, repeatable at the turn of a switch. Low harmonic distortion; wide dispersion of midrange and high frequencies; multiple drivers to handle power levels significantly higher than speakers for home use. Uses one 12-

inch acoustic suspension woofer, four 1½-inch midrange hemispherical domes, and four ¾-inch high-frequency hemispherical

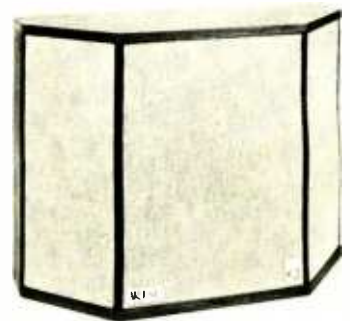

domes.—**Acoustic Research, Inc.**, 24 Thorndike St., Cambridge, Mass. 02141.

Circle 35 on reader service card

REMOTE CONTROL, Whistle Switch. Wireless sound command device turns TV, lights, appliances on and off. Plugs into any 117-volt standard household outlet, then plug any home appliance up to



300 watts capacity into the Whistle Switch. Comes with both squeeze-bulb and mouth whistle to activate the device. Possible uses include: security device for turning on lights in dark areas, to a convenience for bedridden or convalescent persons. \$14.95.—**Signal Science, Inc.**, Box 413, 140 Lowland St., Holliston, Mass. 01746.

Circle 36 on reader service card

STEREO MIXER KIT, Prokit SM-6. All plug-in IC's minimize servicing and troubleshooting problems. Kit forms profes-



sional system for remote or studio recording, and sound reinforcement mixing. Will mix up to six signals simultaneously. Any

input can be switched between line or microphone function. Inputs 5 and 6 can be switched to function as RIAA phono preamps. Input 5 is permanently assigned to output A, input 6 to output B. Other four inputs can be switch-assigned to either output or both at the same time. Microphone preamps can be switched into either high- or low-gain mode. Accessory packages available. \$229.00.—**Gately Electronics**, 57 W. Hillcrest Ave., Havertown, Pa. 19083.

Circle 37 on reader service card

PORTABLE SOLDERING IRON, *Iso-Tip*, cordless rechargeable iron is designed for hobbyist, service technicians, engineers. Construction prevents ac leakage from damaging delicate electronic components. Mimimizes problems caused by

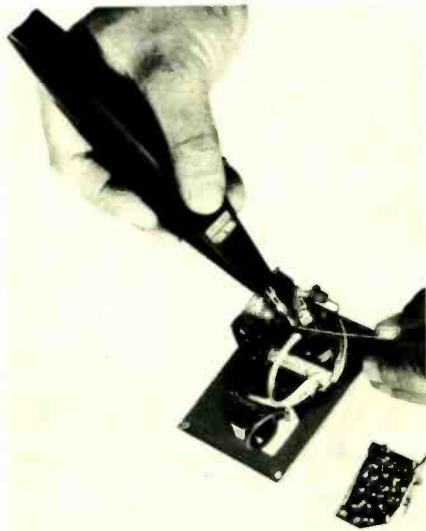

high heat transfer. Tip capacity up to 60 joints per charge; reaches soldering temperature in five seconds; performance equivalent up to 50 watts. Uses nickel cadmium batteries. Overnight recharging. \$19.95.—**Wahl Clipper Corp.**, 2902 Locust St., Sterling, Ill. 61081.

Circle 38 on reader service card

COMPONENT FORMING & MEASURING SYSTEM, *ConForm I*, fits in palm of the hand. Designed to make leads conform to proper hole-to-hole spacing for all axial lead components while compensating for lead thickness, stress relief loops and MIL

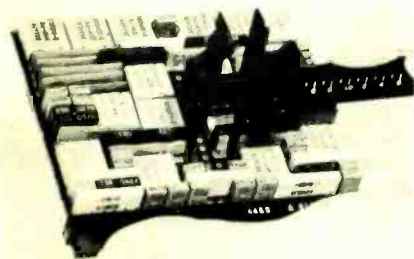

Spec's. Also bends all sizes and shapes of axial lead components for horizontal and vertical mounting with or without stress relief loops. Device straightens transistor leads and provides gauging for cutting leads to suit board thickness and lead

length requirements. \$8.95.—**Pace, Inc.**, 9329 Fraser St., Silver Spring, Md. 20910.

Circle 39 on reader service card

PATTERN GENERATOR, model LCG-384. A digital-clock binary system assures quality test patterns and is among the prin-



cipal features of this mini-portable color-bar pattern generator. Powered by four 1.5V pen-lite batteries (6V total) and ac adaptable, this generator fits into a tool

caddy. The LCG-384 provides 8 patterns including the gated rainbow for testing NTSC color sets. It has two push-button selectable TV channel frequencies, offers full protection against ambient temperature and line voltage changes and is supplied with two battery compartments, carrying case and strap. The unit weighs 2 lbs. \$109.50.—**Leader Instruments Corp.**, 37-27-27th St., Long Island City, N.Y. 11101.

Circle 40 on reader service card

INDOOR TV/FM ANTENNA AMPLIFIERS, *Color Caster Plus series* designed to make signals from a single antenna strong enough to serve every TV and FM receiver in homes, apartment houses, and motels.

**DID YOU KNOW THAT
ADEMCO SELLS & STOCKS
1031 DIFFERENT
COMPLETE ALARM
SYSTEMS AND
COMPONENTS
FOR THE BURGLAR
ALARM TRADE?**



- and offers training in installation work
- and provides technical assistance
- and offers prompt delivery from stock

**IF YOU'RE IN THE BURGLAR ALARM BUSINESS OR
THINKING OF GETTING INTO IT, YOU SHOULD BE USING**

ADEMCO

CONTROL INSTRUMENTS? Ademco stocks 70 different styles.
MAGNETIC CONTACTS? Ademco stocks 18 different styles.
BELLS? Ademco stocks 23 different styles.

**PLUS PHOTOELECTRIC SYSTEMS, POWER PACKS, FOIL
AND HUNDREDS OF OTHER ESSENTIAL COMPONENTS**



ALARM DEVICE MANUFACTURING CO.
A DIVISION OF PITTSWAY CORPORATION
165 Eileen Way, Syosset, L.I., N.Y. 11791

Circle 61 on reader service card

The amplifiers feature dual-diode input circuits protecting them from lighting induced voltages at the antenna terminals. Model TA-84 amplifies all uhf, vhf and FM signals, provides four 300-ohm outputs from a single 300-ohm input, \$40.75. Model TAC-84 is similar, except it is a 75-



ohm unit for use with coaxial cable, and particularly applicable wherever interference is a problem, \$49.95. TA-246, \$31.50. TA-81, \$46.50.—Jerrold Electronics Corp., 401 Walnut St., Philadelphia, Pa. 19105.

Circle 41 on reader service card

ADHESIVE, Permabond. Industrial-strength adhesive for repair and maintenance. Liquid requires no solvents, catalysts, or heat treatments and bonds all hard surface materials to themselves and to each other, including rubber, glass, porcelain, wood, ceramics, metal and most plastics. Water and weatherproof, solvent-free and non-toxic, Permabond is useful to repair autos, cameras, radio and TV cabinets, switches and knobs, sporting goods, motors, lab apparatus, etc.



—Oneida Electronic Mfg. Co., 843 N. Cottage St., Meadville, Pa. 16335.

Circle 42 on reader service card

RATCHET SCREWDRIVER SET, Palm-Grip. Change drivers in the common handle of this screwdriver set which comes with two sizes of Slot drivers, two sizes of Phillips drivers, and 10 sizes of

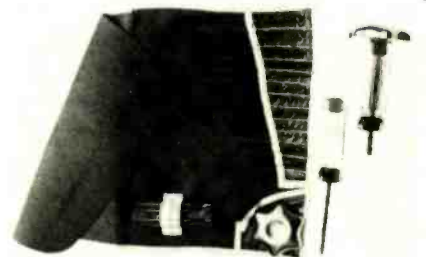

Hex drivers in standard increments. Handy, durable pouch included.—J. Mills Tool & Mfg. Co., Inc., 1444 South 27th St., Phoenix, Ariz. 85034.

Circle 43 on reader service card

EMERGENCY MONITOR, CB-9. Monitors emergency channel 9 or any alternate channel. Full receiver with squelch and volume control, sensitivity 0.5 μ V. Crystal supplied for monitoring channel 9; any other channel or Citizen or business band between



25 and 30 MHz may be monitored on alternate switch by adding plug-in crystal for appropriate frequency. \$39.95.—PACE Div., Pathcom Inc., 24049 S. Frampton Ave., Harbor City, Calif. 90710.

Circle 44 on reader service card

OSCILLOSCOPE, model 553P. 5" CRT has all solid-state circuitry, dual-trace trigger scope is suited for measurement and waveform monitoring applications. With two identical channel operations, the 553P contains a vertical differential dc amplifier that produces a bandwidth of dc to 10 MHz. with a voltage accuracy of $\pm 3\%$. The system displays either channel sepa-

ROTARY SWITCHES

Some single gang, multiple N122. **16 for \$1.00**

SLIDE SWITCHES

All types, SPDT, DPDT, etc. **12 for \$1.00**

TRANSISTOR REPAIR KIT \$1.00

Includes resistors, condensers, transistors, transformers and various & sundry parts used to repair transistor radios, walkie-talkies, tape recorders, etc. **N107**

RADIO & HI-FI KNOBS 100 for \$1.00

All different types, shapes & colors. Some with set screws, others for knurled shafts. **N112**

PRECISION RESISTORS 60 for \$1.00

All 1%, 1/2 watts & 1 watt. From low to high ohmages. **N113**

BARRIER TERMINAL BLOCKS 20 assorted for \$1.00

These are seconds from 2-14 terminals. Some screws missing. All functional. **N126**

FUSE HOLDERS 4 for \$1.00

Standard, for 3AG fuses. **N129**

NC188 100 PC. GIANT PACK OF ASSORTED TRANSISTORS

Silicon Planar, Untested, NPN & PNP. Power, Audio, RF. 100 for \$1.98

MONEY BACK GUARANTEE

Terms: Minimum order \$3.00. Include postage. Either full payment with order or 20% deposit, balance C.O.D.

FREE CATALOG

BARGAIN BONANZA OF EDLIE HIGHEST QUALITY KITS ONLY NEW PRODUCTS

EXCELLENT MIXTURE

FULL YEAR GUAR. RADIO & TV RECEIVING

Acquired from U.S. Defense depots or removed from equipment (new and used). These are laboratory tested and guaranteed for one full year. Most are of such standard makers as RCA, GE, etc.

- 1L4, 1S4, 1S5, 1U4, 1V2, 2BN4, 3A3, 3BC5, 3BY6, 3CS6, 3DK6, 3DT6, 3Q4, 4BC5, 4BN6, 4BZ7, 4DE6, 5X8, 6AC7, 6AG5, 6AH6, 6AM6, 6AN5, 6AU5, 6AY3, 6AV5, 6AX4, 6B8, 6BC5, 6BG6, 6BK5, 6BL8, 6BW8, 6CG3, 6CG7, 6CG8, 6CH8, 6CL8, 6CM6, 6CJ3, 6CS7, 6CQ4, 6CZ5, 6DE4, 6DQ6, 6DT8, 6DW4, 6DX8, 6EB8, 6EJ7, 6EM5, 6EV7, 6EW6, 6FD7, 6FQ7, 6GF7, 6GH8, 6I6, 6JM6, 6JS6, 6K6, 6KA8, 6KT8, 6SL7, 6SV7, 6V4, 6W4, 7Y4, 8CS7, 8EB8, 10DE7, 12AB5, 12AV7, 12BA6, 12BY7, 12DT5, 12EN6, 12EK6, 12J5, 12SN7, 13EM7, 17JZ8, 17BF11, 25C5, 25CU6, 25EH5, 25W4, 25L6, 25Z6, 27, 28D7, 28HE7, 55.

WRITE FOR FREE VALUE PACKED CATALOG

BONUS FREE CUT WIRE

KIT* for any \$5.00 Kit purchase

1/2 WATT CARBONS 100 for \$1.00

All standard ohmages, some 5%. Standard makes. **N150**

CARBON RESISTORS 200 for \$1.00

Most with cut leads (long enough for soldering), some pre-formed. Most all 5% or 10%. **N136**

POWER RESISTORS 35 for \$1.00

Consists of standard makes such as Clarostat, Sprague, etc. Assorted ohmages & wattages. **N109**

DISC CAPACITORS 60 for \$1.00

Assorted capacitances from .0001 to .1. Different voltages, mostly 600 volts N.P.O. **N140**

MINIATURE TRANSISTOR ELECTROLYTES 12 for \$1.00

Some axial leads, some vertical mount, mixed capacitances and mixed voltages. **N121**

1 WATT CARBON RESISTORS 70 for \$1.00

All standard ohmages, some 5%. Standard makes. **N145**

MINIATURE POTS 12 for \$1.00

Used in transistor and miniature applications. **N141**

CRYSTALS 8 for \$1.00

Some for receiving or transmitting; some CB, some Ham, some business band, in different type holders. **N144**

RELAYS 4 for \$1.00

Assorted types, from 6 volts to 110 volts. Some sell for as much as \$10.00. **N155**

EDLIE ELECTRONICS, INC.

2700 F HEMPSTEAD TPKE., LEVITOWN, N.Y. 11756

Circle 62 on reader service card

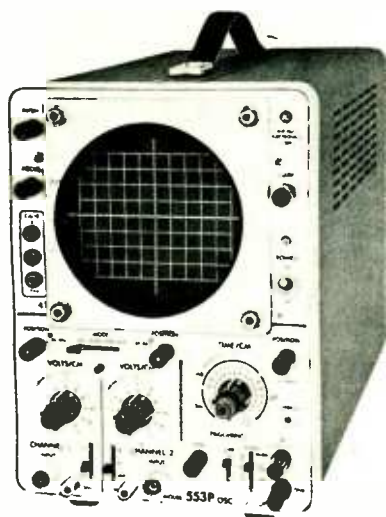

rately, alternates between channels, or choppers between channels. \$538.00.—**Kikusui Electronics Corp.**, 200 Park Avenue, New York, N.Y. 10017.

Circle 45 on reader service card

D.I.P. SOCKETS. Fourteen contact D.I.P. sockets designed with a low profile of 0.218 in. to provide high-density packaging. Large tapered entry channels aid IC insertion and reduce lead damage. Dual-leaf wiping contacts, accepting round or

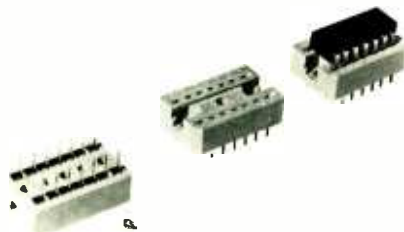

flat leads, insure low contact resistance and high reliability. Body design features mounting points for hexagon bolts or nuts, and standoffs provide an air gap between socket and board.—**Vero Electronics, Inc.**, 171 Bridge Road, Hauppauge, N.Y. 11787.

Circle 46 on reader service card

SPEAKER LINE TESTER, model LTS-1, is a self-contained ac powered direct reading instrument designed to determine the wattage requirement of any 25- or 70-volt speaker line up to 200 watts, the wattage drawn by a speaker with a 25- or 70-volt



transformer, and the impedance of a speaker voice coil. It tests speaker lines, speaker with transformer, and the speaker voice coils for shorts and opens. \$34.75.—**Trutone Electronics, Inc.**, 14660 Raymer St., Van Nuys, Calif. 91405. R-E

Circle 47 on reader service card

new literature

All booklets, catalogs, charts, data sheets and other literature listed here with a Reader Service number are free for the asking. Turn to the Reader Service card on page 101 and circle the numbers of the items you want. Then mail the postage-paid card.

ELECTRONIC CHEMICALS CATALOG, No. 7172. Among the products described are tuner sprays, circuit coolers, insulating sprays, lubricants, tape head and record cleaners, glues and cements, solder, and spray paints. The 12-page catalog is complete with descriptions, applications, tables and pricing for all products.—**Chemtronics Inc.**, 1260 Ralph Ave., Brooklyn, N.Y. 11236.

Circle 48 on reader service card

RADIAL HORN LITERATURE, Model RH-500. Information on an indoor and outdoor radial horn for use in stadiums, auditoriums, transportation terminals and industrial plants is now available. Describes the weatherproof horn designed for high intensity audio in the middle and upper range of the spectrum.—**Atlas Sound**, 10 Pomeroy Road, Parsippany, N.J. 07054.

Circle 49 on reader service card

CONNECTOR & SWITCH CATALOG, No. 7FOM. 24 pages in full color, illustrating IC terminal sockets, connectors and terminals, relay sockets, phono sockets, lighted pushbutton switches, and various tools for hand and production assembly and extraction of components.—**Waldom Electronics, Inc.**, 4625 W. 53rd St., Chicago, Ill. 60632.

Circle 50 on reader service card

SCIENCE & OPTICS, Catalog No. 721. 4,000 unusual items for hobbyists, experimenters, craft enthusiasts, students, gardeners and workshop buffs. Fully illustrated book lists tools, puzzles, games, rockets, microscopes, telescopes, binoculars, photographic attachments, black-light equipment, and unique lighting equipment.—**Edmund Scientific Co.**, 380 Edscorp Bldg., Barrington, N.J. 08007. R-E

Circle 51 on reader service card

IT'S EASY TO ASSEMBLE A SCHOBER ORGAN!

*Includes easy to assemble walnut console kit. (Only \$1575 if you build your own console.) Amplifier, speaker system, optional accessories extra.

You couldn't touch an organ like this in a store for less than \$4,000—and there never has been an electronic instrument with this vast variety of genuine pipe-organ voices that you can add to and change any time you like! If you've dreamed of the sound of a large pipe organ in your own home, if you're looking for an organ for your church, you'll be more thrilled and happy with a Schober Recital Organ than you could possibly imagine—kit or no kit.

You can learn to play it—and a full-size, full-facility instrument is easier to learn on than any cut-down "home" model. And you can build it, from Schober Kits, world famous for ease of assembly without the slightest knowledge of electronics or music, for design and parts quality from the



ground up, and—above all—for the highest praise from musicians everywhere.

Send right now for the full-color Schober catalog, containing specifications of all five Schober Organ models, beginning at \$499.50. No charge, no obligation. If you like music, you owe yourself a Schober Organ!

The Schober Organ Corp., Dept. RE-99
43 West 61st Street, New York, N.Y. 10023

- Please send me Schober Organ Catalog and free 7-inch "sampler" record.
 Enclosed please find \$1.00 for 12-inch L.P. record of Schober Organ music.

NAME _____

ADDRESS _____

CITY _____ STATE _____ ZIP _____

Circle 63 on reader service card



the Troubleshooter

The coldest circuit cooler. Cools to -50°F and leaves no liquid residue. Isolates and pinpoints thermal intermittents. Saves hours of probing and testing. A must for every serviceman.

Preferred by Professionals
CHEMTRONICS INC.
 1260 Ralph Avenue, Brooklyn, N.Y. 11236
 Circle 64 on reader service card

more ways to use your tape recorder



by **BYRON G. WELS**

ONCE UPON A TIME YOU BOUGHT A tape recorder. You took it home, showed it to the family, and let them all take turns making recordings. You smiled as they heard their own voices coming back to them, and then you put the recorder away.

Now we're going to try to interest you in using that tape recorder once again, and maybe make you take it out and try a few new useful and/or amusing little applications. Who knows? You might even leave it out this time!

Play a musical instrument?

If so, you can have a ball with a tape recorder. To begin with, you need a pickup microphone, available from most mail-order houses, for everything from accordions and guitars through harmonicas and saxophones! Connect an appropriate unit to your instrument, plug it into the tape recorder, and you're all set. Record the melody on track one, playing it straight. Then, using sound-on-sound,

record a harmony line or chord accompaniment on track two. Using sound-on-sound, put both voices on track one, and then add another voice



TAPE-RECORDER FUN can be listening to earlier performance while taping sound-on-sound.

Unusual
 tools, hard-
 to-find items.
 Send for
 free catalog!



Diversified collection-

tools of all kinds
 precision instruments
 essential shop items

... convenient
 one-stop shopping
 from your desk.

NC Flasher



National Camera

Dept. GBA
 Englewood, Colorado, 80110

to track two. I've had a lot of fun with this, using my guitar. After recording melody and a chord accompaniment, try slowing the machine to 3¾-inch speed, and record a tremolo accompaniment an octave lower. Then add this to the first track, at the 7½-ips speed. It comes out sounding like a mandolin, and the total effect is astounding. You don't play a musical instrument? Try using your own voice, monitoring track one with earphones while you record track two, and sing a harmony figure. You can make yourself sound like a choral group!

“ . . .Veddy Intderesstink. . .”

Invite a friend or two over, and without their knowledge, make a good, long recording of a conversation. Make sure you get lots of words of all types. Make the recording at 7½ ips. Then cut the words apart. Carefully place them in envelopes, adding duplicates as you get them. Then mark the envelope so you know what words are in each. Now you can actually write a script, and splice the words together so that, in their own voices, your friends are saying entirely different things. With practice, you will learn how to select inflections properly too, making the tape much more realistic.

Automatic sound-slide shows

Got an automatic slide projector? Good! Make a sensing element by attaching two brass standoffs to a piece of plastic about 1 inch by ½ inch, and cementing the plastic base to your tape deck so it is in the path of the tape as it goes to the take-up reel. The back of the tape must be in contact with both posts at all times.

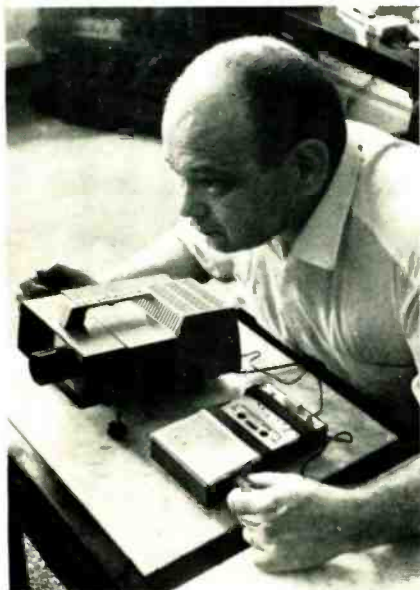

AUTOMATIC SLIDE SHOWS are easy when you use a tape recorder to do the hard part.

Connect a piece of ac line cord to each post, and connect the other end of the cord to the slide projector's remote switch socket. Now arrange your slides, and project the first one on a screen. Record your comments (maybe even some background music and sound effects) on the tape. When you're finished, apply a bit of aluminum sensing tape to the back of the recording tape. When the sensing tape shorts the two posts, the projector will switch to the next slide.

Next time you have people over, plug the slide projector into the tape

recorder, and sit back and enjoy the show with your guests!

“Hello. Hi. Who's this? . . .”

You've heard the bit, and are probably very well aware of it. You telephone a friend, and he says, “Hello”. Then you say, “Hello”. He says, “Who's this”, and so it goes. Get a telephone pickup and connect it to your phone and tape recorder. Start recording all your telephone conversations. After each one, play them back. You aren't trying to “bug” anybody—you're trying to learn how to

FREE!

JUST OFF THE PRESS!!

SEND FOR YOUR EXCITING COPY NOW!



LAFAYETTE 1972 Catalog 720

468 PAGES

**YOUR 1st GUIDE TO
EVERYTHING IN
ELECTRONICS**

Our 51st Year

.....

- Stereo/Hi-Fi Components • Musical Instruments and Amplifiers
- Photography Equipment • Ham and CB Gear • Public Address Systems
- Tools and Test Equipment • Educational and Optical Equipment
- Black and White/Color Televisions • Police and Fire Monitor Receivers
- Books and Parts Plus Thousands of Additional Items

Send For Your Free Lafayette Catalog Today!

Lafayette Radio Electronics, Dept. 17022
P.O. Box 10, Syosset, L.I., N.Y. 11791

**Mail This
Coupon Today
For Your
1972 Catalog
No. 720**

Send Me the Free Lafayette Catalog 17022

Name

Address

City

State Zip

(Please include your zip code)

Circle 66 on reader service card

use a telephone properly. Before long, you'll find yourself making a call, and when the other party says, "Hello", you'll answer, "This is John Smith; may I speak to Mr. Jones, please?" Your phone efficiency factor will zoom. In fact, you will soon lose patience with people who are not efficient on the telephone, and it won't take long at all.

Do-it-yourself language lab

Start out with a packet of 5 x 7 file cards. Mark them at the bottom so that, with the card resting on your tape deck, a pair of marks on the card will indicate the level of the tape. Now, using rubber cement and a razor blade, apply a strip of recording tape at the bottom of each card. When they have all dried, write a word in English on each card. Set your machine to RECORD, and feed the card into the head gap, until the capstan and capstan idler grab the card and pull it through. As it passes through, speak the same word in the foreign language into the mike.

To use this device, look at the card, and try to remember the foreign equivalent for the word. To check yourself, slip it into the head with the machine on PLAY, and you'll

hear the foreign word coming out the speaker!

Record a TV program

Maybe you can't record the video portion of a TV program, but there's nothing to stop you from picking off the audio portion! Unfortunately, with the relatively poor fidelity one gets from today's television set, you'll be better off to slightly modify the television receiver first. Do this by adding a jack to the back of the chassis and connecting the jack across the volume control. Plug in your tape recorder, and make sure you set the recording level before the program starts. The quality of filmed programs is usually pretty poor, but you can do great on live or taped shows, and usually, the sound is worth saving, too. (Better add blocking capacitors—about .05 μ F, 600 volts) to each side of the jack for isolation if your TV is a transformerless type.

"Hello CQ, Calling CQ. . ."

Three times three, three times. That's the way you're supposed to initiate a CQ. A lot of hams lately have taken to using a tape-recorded CQ, as it saves a lot of time and trou-

ble. Simply record a good one, and either play it through your microphone, or plug the tape recorder's output directly into the mike jack (provided the impedances aren't too far off). There's a good chance here for the CW operator, too. Use a relay in place of the speaker on the recorder, and record your CQ in CW. The audio from the recorder's amplifier will key the relay, which in turn will key the transmitter.

Living greeting cards

We all know that tape-response isn't new. Families, separated by many miles, often keep in touch with one another via reels of tape—after all, the spoken word is far more satisfying than written letters. But have you thought about making taped greeting cards? The youngsters especially like these "tapes with a theme."

Got any more good ideas on how to use a tape recorder? Got some special technique of your own? Jot it on a postcard and mail it to Tape Ideas Editor, RADIO-ELECTRONICS, 200 Park Ave. South, New York, N.Y. 10003. We'll pick out the best of those we receive and publish them at some future date for all our readers to enjoy.

R-E

**SOLDERING +
DESOLDERING +
RESOLDERING =**

SOLDER ABILITY
ELEMENTARY TO ELITE

WORLD'S MOST PRACTICAL SOLDER HANDLING TOOLS

meets industries demands....

with a COMPLETELY PORTABLE SOLDERING/DESOLDERING/RESOLDERING SYSTEM



U.S. and Foreign Patents Applied for

EDSYN
15954 ARMINTA STREET
VAN NUYS, CALIFORNIA 91406
PHONE (213) 989-2324
TELEX NO. 65-1469 EDSYNEX VAN

Send for our FREE 16 page **SOLDER ABILITY** manual.

Edsyn is a registered trademark of Edsyn, Inc.



give...so more will live
HEART FUND

audio switching systems

In a search for versatility, I have devised a switching system, so that various parts of an audio system can be operated, without having to plug and unplug the separate parts, or having to turn on more equipment than is necessary. In effect, this unit combines a hi-fi system and an intercom system.

Many of you know that a simple way to feed a signal from a self-contained unit, such as a shortwave receiver, into a high-impedance input of a recorder or amplifier, is to take off the signal across the receiver voice coil and feed it to the input. This is convenient for recording, but suppose you just want to listen to the receiver at some remote point. Why amplify the voice-coil output, since it is all ready to feed a speaker? That is where this unit will come in handy.

The coupling unit consists of 3 switches, which I have labeled WHAT, HOW and WHERE. The WHAT switch selects the program originator such as tuner, tape, etc. which can be high impedance or low impedance. The HOW switch selects the volume level at which the program is to be reproduced. The WHERE switch selects the location where the program will be heard.

A little explanation may be needed about the HOW switch. It has three positions. Position 1 connects a high-impedance program source to a step-down transformer (Stancor A3327 or equal), to operate a speaker directly, without amplification as a low-level background source. If you have 1 to 2 volts at a high-impedance level you can do this. I found this very adequate if the ambient noise level is low.

Position 2 connects the inputs to 5-watt amplifiers for stereo, more serious listening or where there may be higher background noises.

Position 3 has two uses. If the input is low impedance (4, 8 or 16 ohms) to start with, you can send it on to the speakers directly through position 3 and leave the amplifiers off. Position 3 also feeds the signal to the right and left channels of a large stereo amplifier (in the living room).

I did not make any provision for a dummy load on the 5-

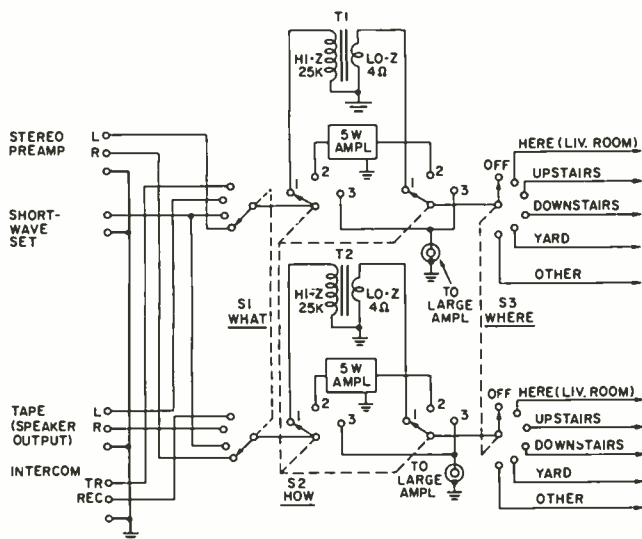

watt amplifiers. This can be done by making S2 a 5-pole switch (both amplifiers using a common dummy load). For my purposes, I found miniature zip cord (2 cond. 24 GA stranded) obtainable from Lafayette, ideal for running between the unit and the remote speakers.—Fred Butterfield

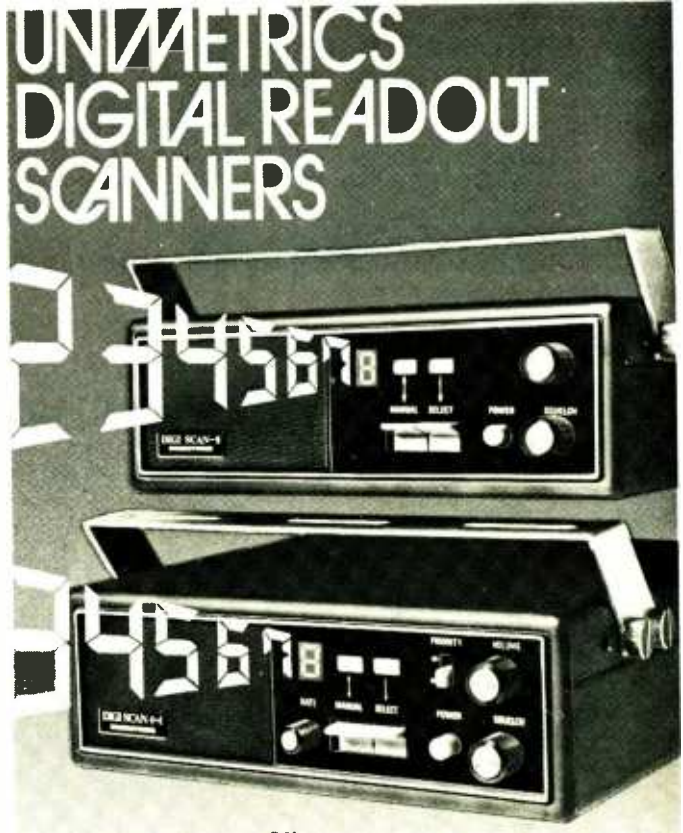

DIGI SCAN-8™

This most popular & best selling digital readout scanner has become infamous for making all other types of monitor receivers obsolete. And you can understand why when you look over the many outstanding features this 8 channel, crystal controlled, FM digital scanner incorporates. Features that include ■ A digital (not just dots) readout indicator that automatically seeks and identifies broadcasting channels ■ Exclusive "Drop-in" front end Printed Circuit Boards for interchangeable Low Band, VHF or UHF monitoring ■ Individual channel lock-out switches for selective programming ■ Variable squelch control ■ "Piano Key" switches for automatic or manual operation ■ "Easy Open" crystal compartment ■ Approx. 0.5 uv sensitivity over a 7MHz band spread ■ Handsome die-cast front panel & vinyl on metal case. These features and more, combined with proven dependable performance have made DIGI SCAN-8 the "standard of comparison" of many Federal & local agencies. "DIGI SCAN-8... the monitor receiver of the 70's, TODAY!"

DIGI SCAN 4+4™

Here are a few of the outstanding features that make the new DIGI SCAN 4+4 so unique that we feel it too will become a best selling scanner along with our famous Digi Scan-8... ■ DIGI SCAN 4+4, like the Digi Scan-8, is an 8 channel digital readout scanner BUT the listener is not restricted to monitoring only one band at a time! DIGI SCAN 4+4 permits simultaneous monitoring of 4 channels on any 2 out of 3 bands! For example: 4 on VHF and 4 on UHF—or 4 on VHF and 4 on Low Band—or 4 on UHF and 4 on Low Band ■ Accommodates any frequency spread within a selected band (i.e.: 4 channels, 150-158MHz, 4 channels, 162-170MHz) ■ Front panel scan rate control ■ Front panel priority channel switch ■ Individual channel "Lock-Out" switches ■ VHF, UHF or Low Band interchangeable "Drop-in" front end modules ■ Extremely fine sensitivity and selectivity ■ Die-cast front panel, vinyl on metal case. If because of the change over in frequency bands by many Federal, State and Municipal agencies, or just because you're missing channels you would like to be monitoring, DIGI SCAN 4+4 is the scanner you've been waiting for.

See your Unimetrics Dealer today for a demonstration of either of these fine digital scanners. Or write to us for complete information and technical specifications. Dealer inquiries invited.



UNIMETRICS, INC.

23 WEST MALL, PLAINVIEW, NEW YORK 11803

In Canada: Western Radio Services, Ltd., 1675 W. 3rd Ave. Vancouver, B.C. Canada

Circle 68 on reader service card

FEBRUARY 1972 • RADIO-ELECTRONICS 77

More kits than ever...over 350...all in your

The most advanced color TV kit we've ever offered.

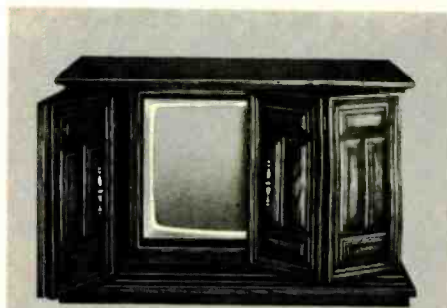
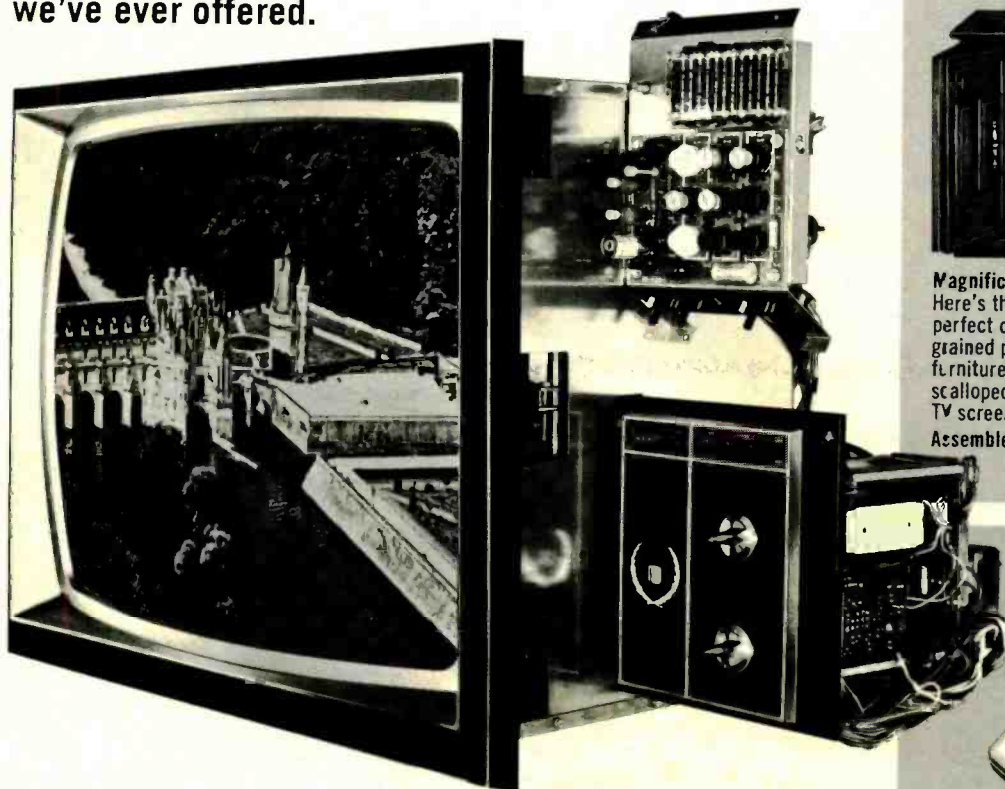

Magnificent Mediterranean Console. Here's the finest TV cabinet we offer, a perfect choice for a GR-900. Has deep-grained pecan veneers on hand-rubbed furniture grade hardwood solids. Two scalloped double-hinged doors hide the TV screen when not in use.
Assembled GRA-405-25, 100 lbs. . . . 179.95*

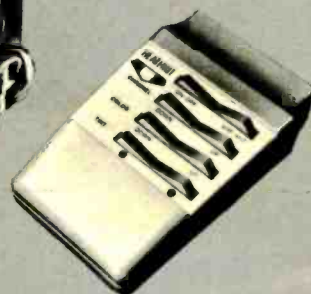

Wireless Remote for your GR-900. The ultimate in armchair viewing. Gives you eight-function across-the-room control of on/off, three preset volume levels, power tuning (up or down), color, tint, UHF/VHF channel selection. Also activates Custom Wall Mount doors.
Kit GRA-900-6, 6 lbs. 79.95*

The new Heathkit GR-900 25V Color TV has UHF/VHF detent tuning & varactor UHF tuner, angular tint control — more features than any other color TV kit! Better performance than any other set.

UHF/VHF detent power tuning. Push a button and you scan the channels in either direction with detent action locking in on VHF channels 2-13 and any 12 preselected UHF stations. A pushbutton selects either UHF or VHF mode, and a lighted dial indicates tuner position. And you can have full remote-control selection too for just a few dollars more.

New voltage-controlled varactor UHF tuner and specially designed VHF tuner with MOS Field Effect Transistor contribute to better fringe-area reception, increased sensitivity.

New angular tint control. A switch now gives you either "normal" or "wide angle" color demodulation to reduce tint and flesh tone change when changing stations and when programs change. Other deluxe features include "instant on" operation with override for conventional on/off operation; automatic fine tuning; adjustable tone control, and an output for playing TV audio through your stereo hi-fi system.

Exclusive Heath MTX-5 ultra-rectangular tube. It's the largest color screen you can buy anywhere, with a full 25 inch meas. diag., 315 sq. in. viewing area. You see virtually everything the station transmits, in the corners and at the sides. The specially etched face plate cuts glare, and reflection, increases contrast without sacrificing brightness, and each dot is projected through a matrix screen to stand out crisply against a solid black background.

Modular solid-state circuitry. Plug-in circuit boards and plug-in transistors make assembly, adjustment and servicing easy. There are 46 transistors, 57 diodes and four ICs — making this one of the most reliable sets we've ever designed.

Other features include automatic chroma control, adjustable video peaking, adjustable noise limiting and gated AGC.

Exclusive Heath self-service built-ins. Your Heathkit GR-900 includes built-in dot generator, tilt-out convergence panel for set-up and periodic adjustments. A handy volt-ohm meter included in the circuitry helps you check your work during assembly, and can be used in conjunction with the manual for any servicing. Like all Heathkit color TVs, the GR-900 gives you complete installation flexibility. There are four beautiful Heath cabinets to choose from plus the new built-in electronic wall mount with hide-away tambour doors. Or you can custom install your GR-900. We think you'll agree, the GR-900 is truly the most impressive color receiver we've ever offered.

Kit GR-900, TV less cabinet, 125 lbs. 599.95*



New Custom Wall Mount. Touch a button on the frame or on your Heathkit Remote Control unit and the folding tambour doors open to reveal your color TV. Kit includes everything needed to build your Heathkit GR-371MX or GR-900 into a wall.
Kit GRA-402-25, walnut finish, 50 lbs. 114.95*
Kit GRA-407-25, unfinished, 50 lbs. 109.95*

FREE '72 HEATHKIT Catalog

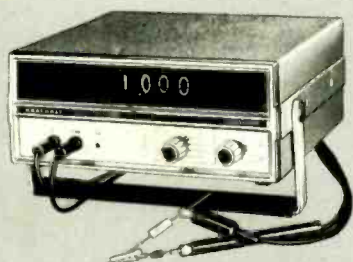

New Heathkit Digital Multimeter 229.95*

A kit-form multimeter that meets lab specs. Has 3½ digits for 100 uV resolution on the 200 mV range, 1V on 1000 V. Five overlapping ranges measure voltage from 100 uV to 1000 V on DC (either polarity); 5 ranges cover 100 uV to 500 V on AC; 10 ranges measure 100 nA to 2A AC or DC; and 6 ranges measure resistance from 0.1 ohm to 20 megohms. Input impedance is approx 1000 megohms on 2V range, 10 megs on higher ranges, with overload protection built-in. DC calibrator supplied permits 0.2% accuracy without external equipment. Can be lab calibrated to 0.1%. For lab performance at a budget price, order your IM-102 today. Kit IM-102, 9 lbs. 229.95*



New Heathkit 10 MHz Triggered Sweep Scope 229.95*

Here's a five-inch triggered sweep scope at a price you can't afford to pass up. Has DC-10 MHz response, calibrated attenuator, 50 ns sweep rate with magnification, AC-DC coupling, 50 mV sensitivity. It's the ideal instrument for general service and design work . . . and its quality design, easy assembly, simple operation and self-service capability make the Heathkit IO-103 one of the greatest scope values on the market today. Order one for your shack, shop, lab or classroom, now. Kit IO-103, 37 lbs. 229.95*

The better-than-ever '72 Heathkit Catalog has the world's largest selection of fun-to-build, money-saving electronic kits . . . including color TV, stereo/hi-fi, organs, home appliances, engine tune-up tools, radio control, portables, shortwave, marine gear, metal locator, instruments, hundreds more. If you don't have this catalog, you've missed seeing over 50 new kits, introduced since the last edition. Send today for your free copy.

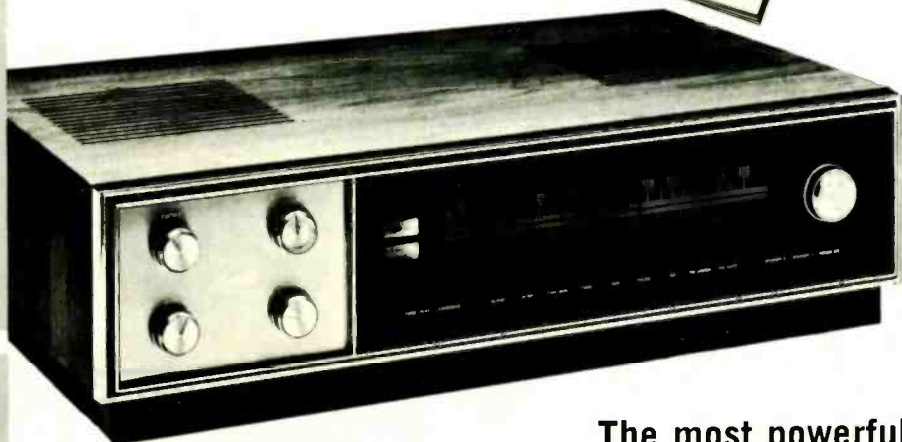

The most powerful and sensitive stereo receiver they've ever tested.

Heathkit AR-1500 AM/FM/FM-Stereo Receiver — ranked by independent experts as the best ever. Here's 180 watts dynamic music power, 90 watts per channel into 8 ohms, 120 watts per channel into 4 ohms. Less than 0.1% intermod distortion, less than 0.25% harmonic distortion. FM selectivity greater than 90 dB, outstanding phase linearity, separation, and low distortion result from two computer-designed 5-pole LC filters. A 4-gang 6-tuned circuit front end offers rock-solid stability, 1.8 uV sensitivity, 1.5 dB capture ratio and 100 dB image and IF rejection. Automatic FM squelch is both noise and deviation activated, fully adjustable for sensitivity.

The AM section, overlooked in most receivers, boasts two dual-gate MOSFETS in the RF and Mixer stages, one J-FET in the oscillator, 12-pole LC filter in the IF, and broad-band detector for good overload characteristics, proper AGC action, no IF alignment and high-fidelity performance. The AR-1500 is an easy kit to build, ten plug-in circuit boards, two wiring harnesses and extensive use of pre-cut wiring with installed clip connectors make assembly fun. Built-in test circuitry uses the signal meter to make resistance and voltage checks as you go. Other features include Black Magic panel lighting that hides the dial markings when the set is not in use; flywheel tuning; pushbutton function controls; outputs for two separate speaker systems, bi-amplification, oscilloscope monitoring of FM multipath; inputs for phono, tape, tape monitor and auxiliary sources — all with individual level controls. The AR-1500 is the critics choice, and with no reservations, the best stereo receiver we've ever designed.

Kit AR-1500, less cabinet, 42 lbs. 379.95*
ARA-1500-1, walnut cabinet, 6 lbs. 24.95*

Send for your FREE 1972 Heathkit Catalog today

HEATHKIT ELECTRONICS CENTERS — ARIZ.: Phoenix, 2727 W. Indian School Rd.; CALIF.: Anaheim, 330 E. Ball Rd.; El Cerrito, 6000 Potrero Ave.; Los Angeles, 2309 S. Flower St.; Redwood City, 2001 Middlefield Rd.; San Diego (La Mesa), 8363 Center Dr.; Woodland Hills, 22504 Ventura Blvd.; COLO.: Denver, 5940 W. 38th Ave.; FLA.: Miami (Hialeah), 4705 W. 16th Ave.; GA.: Atlanta, 5285 Roswell Rd.; ILL.: Chicago, 3462-66 W. Devon Ave.; Downers Grove, 224 Ogden Ave.; KANSAS: Kansas City (Mission), 5960 Lamar Ave.; MD.: Rockville, 5542 Nicholson Lane; MASS.: Boston (Wellesley), 165 Worcester St.; MICH.: Detroit, 18645 W. Eight Mile Rd. & 18149 E. Eight Mile Rd.; MINN.: Minneapolis (Hopkins), 101 Shady Oak Rd.; MO.: St. Louis, 9296 Gravois Ave.; N.J.: Fair Lawn, 35-07 Broadway (Rte. 4); N.Y.: Buffalo (Amherst), 3476 Sheridan Dr.; New York, 35 W. 45th St.; Jericho, L.I., 15 Jericho Turnpike; Rochester, Long Ridge Plaza; OHIO: Cincinnati (Woodlawn), 10133 Springfield Pike; Cleveland, 5444 Pearl Rd.; PA.: Philadelphia, 6318 Roosevelt Blvd.; Pittsburgh, 3482 Wm. Penn Hwy.; TEXAS: Dallas, 2715 Ross Ave.; Houston, 3705 Westheimer; WASH.: Seattle, 2221 Third Ave.; WIS.: Milwaukee, 5215 Fond du Lac.

HEATH COMPANY, Dept. 20-2
Benton Harbor, Michigan 49022



Please send FREE Heathkit Catalog.
 Enclosed is \$_____, plus shipping.

Please send model(s) _____

Name _____

Address _____

City _____ State _____ Zip _____

Prices & specifications subject to change without notice.
*Mail order prices; F.O.B. factory. CL-429

Circle 100 on reader service card

FREE! New '72 Edition Radio Shack Electronic Accessories & Parts Catalog

1000's of
Products
100's of
Exclusives

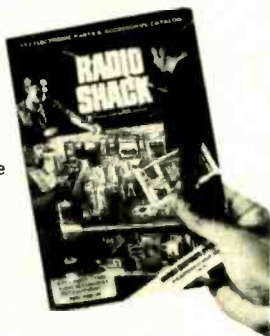

THE buying guide for kit builders, CB'ers, installers, experimenters, hobbyists, electricians — anyone in electronics in any way!

Electronics from A to Z — Antennas, Batteries, Capacitors, Diodes, Educational Kits, Fiber Optics, Grille Cloth, Hi-Fi Speakers, IC's, Jacks, Knobs, L-Pads, Mikes, Needles, Oscillators, P-Boxes, Quad-racs, Resistors, Semiconductors, Telephones, Ultrasonic Alarms, VHF Antennas, Wire, Xenon Strobe, Y Adapters, Zener Diodes plus our Science Fair kits and Knight-Kits — and much more!

Get your **FREE** copy at our nearby store — or mail in coupon today!

Allied RADIO SHACK Dept. RE-14
A WALKER CORPORATION COMPANY
2725 W. 7th St. Fort Worth, Texas 76107
Send me your FREE 1972 Catalog #215
Please PRINT Clearly
Name _____ Apt. # _____
Street or Rte. & Box _____
City _____
State _____ Zip _____

Circle 69 on reader service card

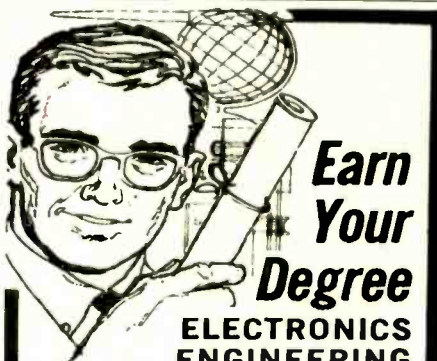

Earn Your Degree

ELECTRONICS ENGINEERING

through HOME STUDY

HIGHLY EFFECTIVE HOME STUDY COURSES IN:

- Electronics Engineering Technology
- Electronics Engineering Mathematics

Earn your Associate in Science Degree in Electronics Engineering and upgrade your status and pay to the engineering level. Complete college level courses in Electronics Engineering. We're a forward looking school. Outstanding lesson material — thorough and easy to understand. Engineering taught on the basis of application and understanding rather than on the basis of memorization. Up to date in every respect. Acquire the knowledge and ability that means the difference between a low paying technician job and a high paying engineering position. Low tuition cost with low monthly payments. Free engineering placement service for our graduates. Write for free descriptive literature. Ask for bulletin R, no salesman will call on you.

COOK'S INSTITUTE
of Electronics Engineering

Forest Hill Road
P. O. Box 10634
Jackson, Miss. 39209

Established 1945

Formerly Cook's School of Electronics

Circle 70 on reader service card

AC circuits nomogram

by A. K. QUINN

The graph on the facing page makes it easy to solve series and parallel circuits containing resistance and reactance. It's simple to use and gives results well within normal parts tolerances.

The conventional way to solve the circuit of Fig. 1, when the reactance of C is known, takes many steps. One way would be the solving equations like

$$Z = \sqrt{X^2 + R^2}$$

which requires squaring and square root. Another would be to draw vectors and either measure phase angles with a protractor or look up values in trig tables.

Consider the circuit in Fig. 1. Assume we want to find the voltages across C and R, the current, the impedance, the phase angle, and the power factor. The graph, plus some Ohm's-law arithmetic, will give us all those quantities.

Here's how to go about it.

1. Divide the reactance by the resistance. For our example, this would be $7,000/10,000$, or 0.7.
2. Locate 0.7 on the left-hand vertical axis. A straightedge laid straight across the graph at this point shows that 0.7 corresponds to a phase angle of 35° .
3. The straightedge cuts scale A at about 0.58. Multiply this by the applied voltage 200 volts times 0.58 gives us 116 volts. This is the voltage across C.
4. The corresponding point on scale B is 0.82. Multiply this by 200 volts and we get 164 volts across R. Scale B also gives the power factor, 0.82.
5. Ohm's law gives us the value of current as E_R/R , or $164/10,000$, or 16.4 mA.
6. Impedance is 200 volts/16.4 mA or 12,200 ohms.

Series R-C-L circuits

These circuits are even simpler. Look at Fig. 2.

1. Subtract X_C from X_L .
2. X/R gives the vertical axis index, as with the last example.
3. Scale B value gives a multiplier for E_R
4. Current is E_R/R
5. E_C is I times X_C

6. E_L is I times X_L
7. E_L is I times X_L
8. Z is E_A/I
 $60 - 40 = 20 (X)$
 $20/20 = 1 (Index)$
0.71 (Multiplier)
 $E_R = 0.71 \times 100 = 71V$
 $I = 71/20 = 3.5 \text{ amps}$
 $E_C = 3.5 \times 40 = 140V$
 $E_L = 3.5 \times 60 = 210V$
 $Z = 100/3.5 = 2.9 \text{ ohms.}$

Parallel ac circuits

For these circuits, procedure varies, because now we are looking for different things. We know the voltage across the components, but we want to find the current through each component, the total current, the impedance, phase angle and power factor. (See Fig. 3.)

1. Find the current through each com-

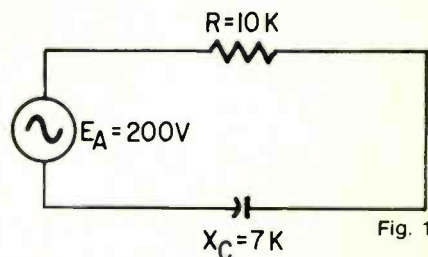

Fig. 1

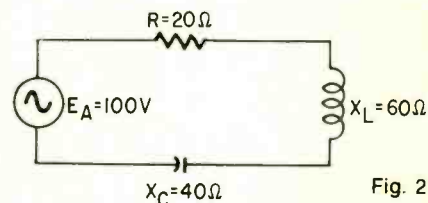

Fig. 2

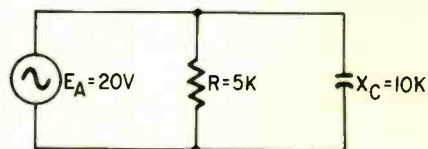

Fig. 3

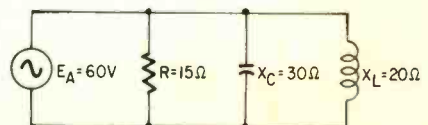

Fig. 4

TV TECH AID

Takes you right to the source of the trouble... without guesswork and wasted time!

You receive each month OVER 40 ACTUAL CAUSES AND CURES OF COLOR AND B-W TV TROUBLE SYMPTOMS . . .

reported by leading TV manufacturers, technicians and field reps . . . each presented in a concise, brief format, including a clearly marked schematic diagram of the associated circuitry . . . no wading through unnecessary details!

You also receive timely and complete information about CIRCUIT MODIFICATIONS AND OTHER VALUABLE SERVICE DATA relating to both new and existing TV models.

Start or expand your own file of causes and cures with TV TECH AID . . . arranged so you can file them by make and model, by trouble symptom or use your own system:

SUBSCRIBE or RENEW NOW!

only \$7.95 per year (12 issues) (that's less than 67¢ per month!)

NEW!

Over 400 Causes and Cures of Recurring Troubles in major-brand Black-and-White TV

All in one large, easy-to-use issue All for only \$5.95 . . . Less than 1½¢ per tip . . . each of which can save you hours of valuable troubleshooting time!

TV TECH AID
P.O. BOX 603
KINGS PARK, N.Y. 11754

ENCLOSED IS A CHECK OR MONEY ORDER FOR \$

PLEASE SEND:

1971—12 ISSUES—\$7.95
 1970—BOOK FORM—\$5.95
 1969—12 ISSUES—\$4.95
 1971 B-W BOOK—\$5.95
 1972—12 issues—\$7.95

TO:
NAME

ADDRESS

CITY

STATE ZIP

The math for ac circuits is generally tedious and boring. This nomogram speeds the solutions to R-C, R-L and R-C-L networks.

ponent by dividing the applied voltage by the resistance or reactance.

$$I_C = E_A / X_C = 20 / 10,000, \text{ or } 2 \text{ mA.}$$

$$I_R = E_A / R = 20 / 5,000, \text{ or } 4 \text{ mA.}$$

2. Divide R by X_C . $5,000 / 10,000 = 0.5$. This is the index, or left vertical axis value. It corresponds to a phase angle of 26° .

3. A straightedge at 0.5 cuts scale B at 0.90. This is the power factor.

4. Now divide I_R by 0.9 to get the total current (I_T). For example, I_T will be $4 \text{ mA} / 0.9$, or 4.5 mA.

5. Impedance is E_A / I_T , or $20 \text{ V} / 4.5 \text{ mA}$, or 4.450 ohms.

Parallel RCL circuits

This type of circuit is shown in Fig. 4.

1. I_R , I_C , and I_L are found by Ohm's law. $60 / 15 = 4$ amps. $60 / 30 = 2$ amps. $60 / 20 = 3$ amps.

2. $I_L - I_C$ gives 1 amp, which we will call I_X .

3. I_X / I_R gives us our vertical index value. $1 / 4 = 0.25$

4. Read scale-B value as 0.97 (power factor). Phase angle is 14° .

5. $I_R / (\text{scale-B value})$ gives I_T . $4 / 0.97 = 4.13$ amps.

6. E_A / I_T gives impedance. $60 / 4.13 = 14.5$ ohms.

You'll note that in all the applications, scale B is associated with resistive voltage or current. Scale A is associated with reactive voltage or current. Knowing that makes it easier to find and use the right scale.

The graph is not absolutely precise, yet it yields solutions well within practical tolerances, and is easier to use than other approaches that rely on vectors, square roots or trig tables. **R-E**

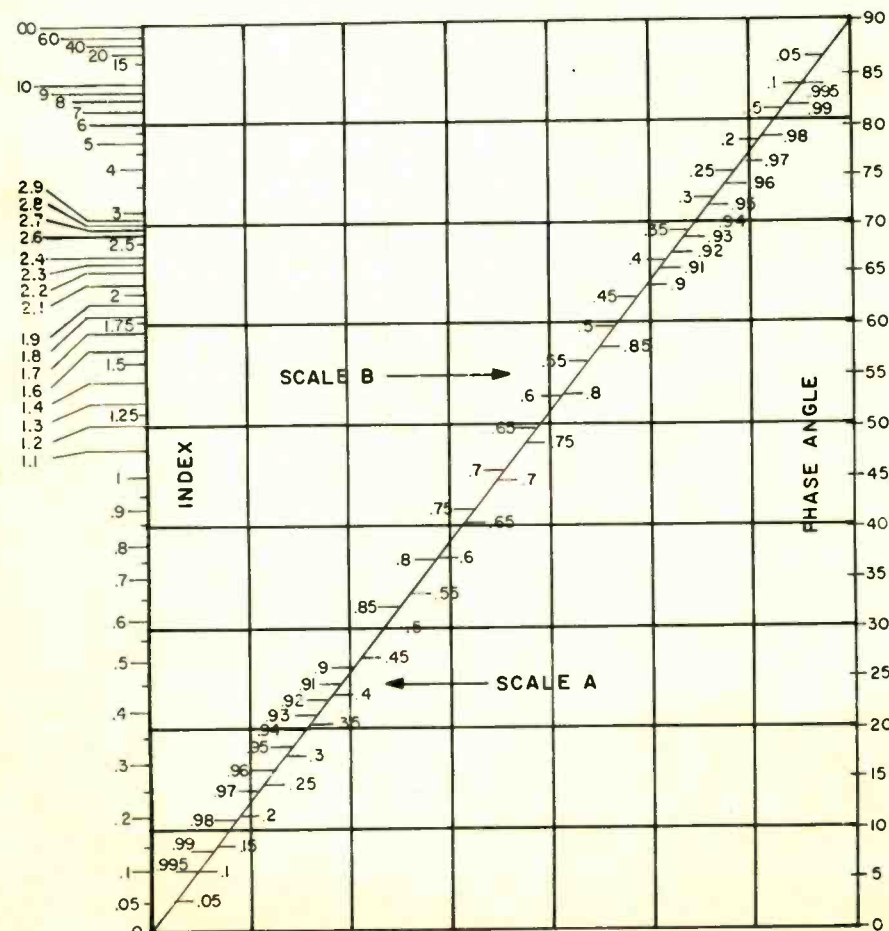

AT LAST! PROFESSIONAL HOME PROTECTION EVERYONE CAN INSTALL AND AFFORD.

Model FC-100
\$49.95
WIRED



- Start your custom Burglar/Hold-up/Fire Alarm System with the FC-100. Add on Sensors, Alarms and Accessories to suit your own needs.
- "Do-it-Yourself" Installers Handbook included. No technical knowledge needed—No soldering.
- 100% Professional in Design, Reliability, Performance.



'Fail Safe'-SYSTEM BY EICO

A New Concept in "Do-it-Yourself" Home Protection

FREE 32 PAGE EICO CATALOG

For latest catalog on EICO Test Instruments, Stereo, EICOCRAFT Projects, Environmental Lighting, Burglar/Fire Alarm Systems, and name of nearest EICO Distributor, check Reader Service Card or send 25¢ for First Class mail service.

EICO, 283 Malta Street, Brooklyn, N.Y. 11207



Circle 73 on reader service card

new books

RCA TRANSISTOR, THYRISTOR & DIODE MANUAL (Technical Series SC-15). RCA Solid State Div., Somerville, N. J. 08876. 5 x 8 in., 768 pages. Soft cover. \$2.50.

This, the latest edition of the RCA semiconductor manual, has been expanded and updated to cover the latest developments in solid-state technology and application. Too, the technical data has been regrouped according to product type (small-signal bipolar transistors, MOS transistors, low- and medium-frequency power transistors, rf power transistors, etc.) to facilitate selection of the optimum device for a particular application. An index to specific devices is included.

The Circuits Section includes several new additions and the circuits carried over from previous editions have been modified and updated to reflect current practices in circuit design and applications.—RFS

SERVICING ELECTRIC ORGANS, 1969 from TAB Books, Blue Ridge Summit, Penna. 17214. By Max H. Applebaum and Donald A. John. 8 1/2 x 11 in. 160 pp. Bound in simulated leatherette. \$7.95.

This book is a handy reference for those interested in repairing and tuning electronic organs. It covers actual technical aspects of organs, presents a history of the organ as a musical instrument, and the way the organ basically functions, for better understanding of the possibilities of what could go wrong. The section on troubleshooting hints is heavily illustrated to show organ troubles and their causes.

There is a separate 36-page fold-out section of typical organ schematics. Step-by-step tuning methods, which do not require previous musical knowledge, are also detailed.—JW

Try Us — You'll Like Us

FREE \$1 BUY WITH EVERY 10 YOU ORDER

Only applies to "\$1" Buys

FREE GIFT WITH EVERY ORDER

- 70° COLOR TUBE BRIGHTNER \$3.95
- 90° COLOR TUBE BRIGHTNER \$4.95
- HEAVY DUTY COLOR FOCUS RECTIFIER 14,000 PIV @ 1 ma \$1
- 50 — OIL IMPREGNATED TUBULAR CAPACITORS Porcelain, Axial Leads—Most popular values \$3.95
- COLOR-TV RECTIFIER — Used in most color sets—6500 kv \$1.95
- 15 — ASST. ROTARY SWITCHES all popular types \$20 value \$1
- 15 — G.E. #NE-2 TUBES Neon Glow Lamp for 101 uses \$1
- 30 — .005 DISC CERAMIC CAPACITORS C.R.L. \$1
- 3—ELECTROLYTIC CONDENSERS most popular number 50/30—150v \$1
- 7 — TV ELECTROLYTIC CONDENSERS desirable types \$1
- 12—MINIATURE ELECTROLYTIC CONDENSERS For Transistor & miniature work \$1
- 10 — MINIATURE 456KC IF TRANSFORMERS Exceptional value —PC—1 1/4" x 1 1/4" \$1
- 2 — BELFUSE #450-1 ad 3-1 RCA Replacement 945392-4 and 945392-3 \$1
- UHF OR VHF MATCHING TRANSFORMER Simple Fool-proof installation \$1
- 2—ELECTROLYTIC CONDENSERS C.D. 500 mfd—200 volts \$1
- STEREO HEADPHONES Hi-Fi Quality... Complete with Stereo plug \$5.95

- UHF TUNER — TRANSISTOR TYPE Used in all TV sets \$3.95
- STANDARD TUNER — TRANSISTOR (GUIDED GRID) 4 Channel closed circuit \$1
- 20 — DIPPED MYLAR CAPACITORS .01—600V \$1
- 20 — DIPPED MYLAR CAPACITORS .033—600V \$1
- 20 — DIPPED MYLAR CAPACITORS .0033—1000 V \$1
- 20 — DIPPED MYLAR CAPACITORS .04—400 V \$1
- 15 — MOLDED TUBULAR CAPACITORS .068—400 V \$1
- 6 — MINIATURE ELECTROLYTIC CAPACITORS 5 MFD—150 V \$1

SARKES TARZIAN TUNER 41mc

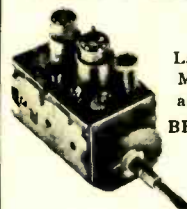

Latest Compact Model good for all 41 mc TV's. BRAND NEW—

Best TUNER "SARKES TARZIAN" ever made—last word for stability, definition & smoothness of operation. An opportunity—to improve and bring your TV Receiver up-to-date. \$7.95 COMPLETE with Tubes

- ### KNOB SPECIAL
- 100 — ASSORTED RADIO KNOBS All standard types \$20 value \$1
 - 50 — TV KNOBS — POPULAR TYPES Mostly Selector & Fine Tuning \$1
 - 25 — VERTICAL LINEARITY KNOBS Long shank... Front mount... miniature assortment \$1
 - 30 — VERTICAL LINEARITY KNOBS Side mount... Standard sizes \$1
 - 25—KNURLED RADIO KNOBS Hard to get... Best selection \$1
 - 40 — DELUXE RADIO KNOBS Choice assortment... Popular types \$1

ANY 6 KITS FOR \$5

- TRANSISTOR RADIO *asst type* good, bad, broken, as-is, potluck \$1.50
- TAPE RECORDER—assorted types good, bad, broken, as-is, potluck \$4
- 300 — ASST. 1/2 W RESISTORS Top Brand, Short Leads, Excellent Selection \$1
- 100—ASST 1/4 WATT RESISTORS stand. choice ohmages, some in 5% \$1
- 100—ASST 1/2 WATT RESISTORS stand. choice ohmages, some in 5% \$1
- 70 — ASST 1 WATT RESISTORS stand. choice ohmages, some in 5% \$1
- 35 — ASST 2 WATT RESISTORS stand. choice ohmages, some in 5% \$1
- 50 — PRECISION RESISTORS asst. list-price \$50 less 98% \$1
- 20 — ASSORTED WIREWOUND RESISTORS 5, 10, 20 watt \$1
- 10—ASSORTED SLIDE SWITCHES SPST, SPDT, MPDT, etc. \$1

- 2 — COLORBURST QUARTZ-CRYSTAL For Most Color TV sets 3579.545 KC \$1.89
- 2 — ELECTROLYTIC CAPACITORS CD — 40/40 MFD — 450 Volts \$1
- 1 — VACO MONO CARTRIDGE Model TO-45X \$1
- 1 — 6" x 9" HEAVY DUTY 10 OZ. SPEAKER Ceramic Type 8 Ohm \$3.69
- \$20 — SHURE M7D DIAMOND NEEDLE exact replacement \$3
- SHURE M44 SERIES DIAMOND NEEDLE exact Replacement \$4.69
- 4 — 9 VOLT MOTORS Excellent for hobbyist \$1
- 200' — #24 SOLID PUSH BACK WIRE Yellow or Black excellent buy \$1
- MATCHED PAIRS TRANSISTORS NPN & PNP (2N4252-2N2904) (2N2222-2N2907) Each set \$1
- RONETTE STEREO CARTRIDGE latest dual sapphire flipover type \$2
- 6 — TRANSISTOR RADIO EARPIECES wires complete with plug \$1
- 5 ASSORTED GLOBAL VARI-SISTOR Popular replacements for most COLOR TV \$1
- 10 — SETS PHONO PLUGS & PIN JACKS RCA type \$1
- 5—PRINTED CIRCUIT IF TRANSFORMERS 4-Lug, 456 KC \$1
- 25 — 3900-OHM-7w RESISTOR 10% Corning glass \$1
- 20 — 47-600V CONDENSERS White Ceramic C.D.—American \$1
- 13 Pc. SCREWDRIVER & NUTDRIVER SET reg \$8.95 \$4.50

IMMEDIATE DELIVERY . . . Scientific light packing for safe delivery at minimum cost. HANDY WAY TO ORDER: Pencil mark or write amounts wanted in each box, place letter F in box for Free \$1 BUY. Enclose with check or money order, add extra for shipping. Tearsheets will be returned as packing slips in your order, plus lists of new offers. Minimum Order \$3.00

Please specify refund on shipping overpayment desired: CHECK POSTAGE STAMPS MERCHANDISE (our choice) with advantage to customer

BROOKS RADIO & TV CORP., 487 Columbus Ave., New York, N. Y. 10024

212-874 5600
TELEPHONE

ENGINEERING CIRCUIT ANALYSIS, by William H. Hayt, Jr. and Jack E. Kemmerly. McGraw-Hill Book Co., 330 W. 42nd St., New York, N.Y. 10036. 6 1/2 x 9 1/2 in., 653 pp. Hardcover, \$15.50.

Intended for use as text for a first course in electrical engineering. The concepts covered include the resistive circuit, natural response and complete response to dc excitation of the simpler RL, RC, and RLC circuits, frequency domain, complex-frequency, magnetic coupling, and transform methods in circuit analysis.—MCL

BASIC ELECTRONICS PROBLEMS SOLVED, by Donad A. Smith. Tab Books, Blue Ridge Summit, Pa. 17214, 192 pp. 5 1/2 x 8 1/2 in. \$7.95 hardbound, \$4.95 clothbound.

Answers basic electronics problems dealing with solid-state and tube-type circuits. Concentrates on problem solving giving detailed explanations with answers. Starts with simple problems, then goes on to dc circuits, semiconductors and power supplies, all the way through the use of the slide rule.—JW

RCA SHUTS DOWN SERVICEAMERICA

December 31, 1971 was the last day of business for RCA's ServiceAmerica operation. Established in three test markets (Philadelphia, San Francisco, and Miami), ServiceAmerica was to repair all makes of tv sets and other home-entertainment equipment. RCA stated that its results in the test markets did not justify the investment of manpower and other resources needed to expand ServiceAmerica nationally.

3 Instruments in One!



**NEW EICO
TRANSISTOR
ANALYZER**

**Model 685
\$99.95
KIT**

FACTORY WIRED \$149.95

Nobody but Eico makes the troubleshooting of solid state equipment so quick, easy, versatile and precise for the professional electronics technician and engineer—and at such low cost!

- Dynamically tests transistors in and out of circuit.
- Performs the 4 basic tests on all types of FETs including pinch-off.
- Performs the 3 basic tests on all types of bipolar transistors.
- Tests for true transconductance and AC Beta, in and out of circuit.
- Tests all types of diodes and measures zener voltage.
- Tests SCRs, TRIACs, and UJTs.
- Incorporates easy-to-use DC Voltmeter and Ohmmeter.
- 50 uA taut band meter movement.

FREE 32 PAGE EICO CATALOG

For latest catalog on EICO Test Instruments, Stereo, EICOCRAFT Projects, Environmental Lighting, Burglar/Fire Alarm Systems, and name of nearest EICO Distributor, check Reader Service Card or send 25¢ for First Class mail service.

EICO, 283 Malta Street, Brooklyn, N.Y. 11207



Circle 73 on reader service card

CANADIANS: Ordering is easy — we do the paperwork — try a small order

WESTINGHOUSE ALL TRANSISTOR HOME/OFFICE MESSAGE CENTER

Leaves messages for other for replay . . . Built in speaker/microphone for talk-into convenience . . . Records up to 3 minutes of messages . . . Illuminated signal shows when a message is waiting. Control adjusts playback volume without affecting recording volume . . . Capstan Drive;
BRAND NEW SOLD AS IS \$7.95



IBM COMPUTER SECTIONS

8 assorted Units we sell for \$1 are loaded with over 150 valuable parts.
Incl. — Transistors
Condensers, Resistors, Heat Sinks, Diodes, Etc.

**8 for \$1
100 for \$10**

SHANNON MYLAR RECORDING TAPE

2 1/2" — 225' .. \$.17	7" — 2400' .. \$1.79
3" — 225' .. \$.19	7" — 3600' .. \$2.95
3" — 300' .. \$.27	CASSETTE 60 minutes .89
3 1/4" — 600' .. \$.58	CASSETTE 90 minutes 1.54
5" — 600' .. \$.62	CASSETTE 120 minutes 1.97
5" — 900' .. \$.80	
5" — 1200' .. \$.97	2 1/2" TAPE REEL .. \$.05
5" — 1800' .. \$ 1.49	3" TAPE REEL .. \$.06
7" — 1200' .. \$.77	3 1/4" TAPE REEL .. \$.07
7" — 1800' .. \$ 1.12	5" TAPE REEL .. \$.14
	7" TAPE REEL .. \$.15

- WESTINGHOUSE FM TUNER \$2.99 (12D78 Tube)
- WESTINGHOUSE FM TUNER #476-V-015D01 Transa- \$3.99 for
- 300 — ASSORTED HEX NUTS 2/56, 4/40, 5/40, 6/32, 8/32 .. \$1
- 250 — ASST. SOLDERING LUGS best types and sizes .. \$1
- 250 — ASST. WOOD SCREWS finest popular selection .. \$1
- 250 — ASST. SELF TAPPING SCREWS #6, #8, etc. \$1
- 150 — ASST. 6/32 SCREWS and 150 6/32 HEX NUTS .. \$1
- 150 — ASST. 8/32 SCREWS and 150 8/32 HEX NUTS .. \$1
- 150 — ASST. 2/56 SCREWS and 150 2/56 HEX NUTS .. \$1
- 150 — ASST. 4/40 SCREWS and 150 4/40 HEX NUTS .. \$1
- 150 — ASST. 5/40 SCREWS and 150 5/40 HEX NUTS .. \$1
- 500 — ASSORTED RIVETS most useful selected sizes .. \$1
- 500 — ASSORTED WASHERS most useful selected sizes .. \$1
- 100 — ASST. RUBBER BUMPERS for cabinet bottoms & other uses .. \$1
- 100—ASSORTED RUBBER GROMMETS best sizes .. \$1

RCA 110° FLYBACK TRANSFORMER



We scooped the Market Latest type — standard for all 110° TV's
RCA's design of large Coil produces 18KV— assuring adequate width Incl Schematic Diagram application for any TV
List price \$13.90
Your price .. \$3
10% off in lots of 3

- 110° TV DEFLECTION YOKE for all type TV's incl schematic \$3.95
- "COMBINATION SPECIAL" RCA 110° FLYBACK plus 110° DEFLECTION YOKE \$5.95
- 90° FLYBACK TRANSFORMER for all type TV's incl schematic .. \$2
- 90° TV DEFLECTION YOKE for all type TV's incl schematic .. \$2
- 70° FLYBACK TRANSFORMER for all type TV's incl schematic .. \$2
- 70° TV DEFLECTION YOKE for all type TV's incl schematic .. \$2
- 2 — TV CIRCUIT BREAKERS Rated 4.2 TO 5.0 AMPS, etc. \$1.19
- 70° COLOR YOKE For all round color CRT's .. \$12.95
- 90° COLOR YOKE For all Rectangular 19 to 25" Color CRT's .. \$10.95

- 10 — STANDARD TRANSISTORS NPN & PNP 2N404, 2N414, etc.
- 10—ASSORTED DIODE CRYSTALS 1N34, 1N48, 1N60, 1N64, etc.
- 3 — TOP BRAND SILICON RECTIFIERS 1 amp, 1000 PIV
- COLOR POWER TRANSFORMER — Good for most sets 28R150 \$6.95 List Price—\$36.75
- 4—50' HANKS HOOK-UP WIRE assorted colors .. \$1
- 100'—SPOOL SPEAKER WIRE 2 cond. mult zip, clear, 101 uses .. \$1.50
- 10 — ASST. RADIO & TV TUBES Every Tube a good number .. \$1
- 5 — I.F. COIL TRANSFORMERS 456-ke for Transistor Radios .. \$1
- 5 — AUDIO OUTPUT TRANSFORMERS Sub-min for Trans Radios .. \$1
- TV TWIN LEAD-IN 300 ohm 500' — \$7.100'—\$1.50 50' — \$1
- CO-AX CABLE RG59U grey or black 250'—\$9.100'—\$3.69 50'—\$1
- 4 — TV ALIGNMENT TOOLS most useful assortment #1 .. \$1
- 4 — TV ALIGNMENT TOOLS For Color TV #2 .. \$1.49
- 6 — TV COLOR ALIGNMENT TOOLS Most popular type .. \$2.79
- 5 — PNP TRANSISTOR general purpose, TO-5 case .. \$1
- 5 — NPN TRANSISTORS general purpose, TO-5 case .. \$1
- UNIVERSAL TV ANTENNA Hunk of set Mounting 5 section rods .. \$1.98
- 50 — ASSORTED TRANSISTORS big factory scoop—sold as-is .. \$1
- RCA COLOR FLYBACK Part #113382 (Stancor #HO-601C) .. \$12.95

MARKET SCOOP COLUMN

- 6" UNIVERSAL SPEAKER Top quality Special buy \$1.29 Ea. 5 for \$5
- 12" UNIVERSAL SPEAKER Top Quality .. Large Magnet .. \$4
- 10" PHILCO SPEAKER Top Quality .. Large Magnet .. \$2.69
- 8" UNIVERSAL SPEAKER Large Magnet—Special Buy .. \$2.49
- 5" UNIVERSAL TWEETER 1 Oz. .. Magnet .. \$1.29
- UNIVERSAL 4" PM SPEAKER With 501.6 Output Transformer .. \$1
- 2 1/2" x 4" SPEAKER Special Buy 10 For \$5— 69¢ Ea.
- 3 1/2" — ROUND SPEAKER Special Buy .. \$5.95
- 4" x 6" "QUAM" 16 OHM SPEAKER Large magnet .. \$1.79 Special BUY (10 for \$15.00)
- CRYSTAL LAPEL MICROPHONE High Imped. 200. 6000 ohm .. 11 for \$5 .. 49¢ ea.
- MONO PHONO ARMS Most popular type .. Used in most Transistorized phono Players (13 for \$12.00) .. \$1
- RCA — SK3054 — NPN TRANSISTOR General Replacement Voltages up to 50 Volts (5 for \$5.00) .. \$1.25
- SPECIAL TUBE BUY (8J8-12BH7-12D78-12SG7-12PX50-1K3) .. 75¢ Ea.
- ALL AMERICAN TUBE KIT (12AV6-12BE6-12BA6-35W4-50C5) .. \$2.49

Circle 74 on reader service card

laser experiment

Coherence is one of the prime characteristics of laser light. Try this experiment

Consider an ideal elementary sinusoidal wave form. The characteristics of this wave are its amplitude A (its height above the zero line) and its wavelength λ (the distance from wave peak to wave peak). In this case, the amplitude varies with time in a constant sinusoidal manner and with the maximum remaining the same. The wavelength also remains constant, as the wave propagates (Fig. 1).

Temporal coherence

The definition of coherence involves two or more waves rather than just one. Consider two waves, one superimposed over the other on the same line of propagation. (Figure 2 shows the two waves with the super-imposition modified for clarity.)

First, disregard the amplitudes of the points and consider points *only* with respect to the direction of propagation.

During a time t , each of the two waves advances down the line of propagation to a wave peak, point 1 on wave A_1 and point 2 on wave A_2 . They are traveling at the same speed and have the same wavelength and, if allowed to continue, the wave peaks will occur at the same places all the way down the line. These waves are said to be in phase and coherent. This particular coherence, that is, with respect to time, is called temporal coherence.

With this in mind, we can now define coherence. Two or more waves are said to be coherent if the "phase difference" between two pairs of points, one on each wave, *remains constant*. If our example, where the waves are in phase, the phase

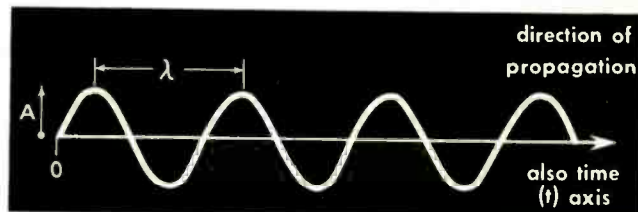

Fig. 1

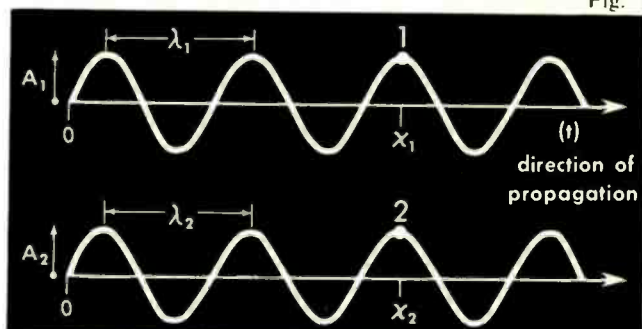

Fig. 2

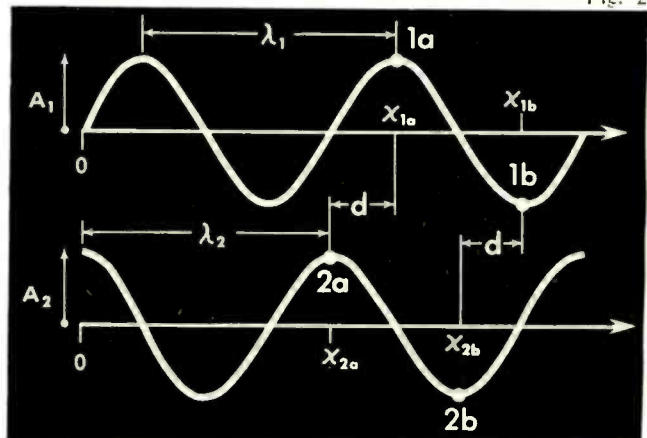

Fig. 3

difference is zero throughout and thus constant.

Figure 3 shows a slightly different situation. In this case, one wave "lags" the other slightly, but the waves are still temporally coherent because the sets of points remain at constant distance d apart along the line of propagation. They are not in phase but have a constant phase difference.

Interference

Up to this point, the amplitude of the waves being discussed has been ignored to stress other factors.

Consider two waves superimposed on each other along the same line of propagation. It is well known that as a wave moves through a media, it propagates a disturbance along the direction of propagation. The amount of disturbance depends on the amplitude of the wave. When the amplitude is positive (i.e. when a peak is formed or the wave point is moving up), it is termed positive disturbance. Alternately, when the amplitude is negative, it is termed negative disturbance.

If two waves are superimposed on one another along the same line of propagation, the amplitudes add. If there are two positive amplitudes, they total to a greater positive amplitude. Two negative amplitudes follow the same formula, adding to a greater negative amplitude. If, however, a negative amplitude is paired with a positive, the difference between the two is found for the total amplitude.

The interaction of two waves as described above is called

Accuracy like a VTVM... Convenience like a VOM...

NEW BATTERY-OPERATED FET SOLID-STATE VOLT-OHMMETER #116

Easy-to-build KIT

\$29⁹⁵ # 116K

Factory-Wired & Tested

\$40⁹⁰ # 116W

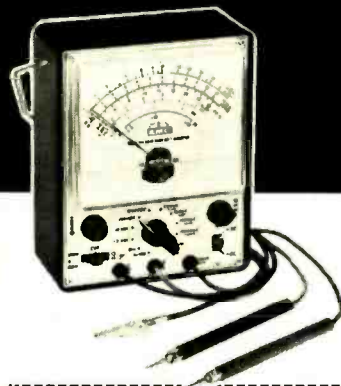

Now you can get all the benefits of a VTVM (laboratory accuracy, stability and wide range) but with its drawbacks gone: no plugging into an AC outlet, no waiting for warm-up, no bulkiness. New Field Effect Transistor (FET) design makes possible low loading, instant-on battery-operation and small size. Excellent for both bench and field work.

Compare these valuable features:

- High impedance low loading: 11 meg-ohms input on DC, 1 megohm on AC
- 500-times more sensitive than a standard 20,000 ohms-per-volt VOM
- Wide-range versatility: 4 P-P AC voltage ranges: 0-3.3, 33, 330, 1200V; 4 RMS AC voltage ranges: 0-1.2, 12, 120, 1200V; 4 DC voltage ranges: 0-1.2, 12, 120, 1200V; 4 Resistance ranges: 0-1K, 0-100K, 0-10 meg., 0-1000 meg.; 4DB ranges: -24 to +56DB.

Sensitive easy-to-read 4 1/2" 200 micro-amp meter. Zero center position available. Comprises FET transistor, 4 silicon transistors, 2 diodes. Meter and transistors protected against burnout. Etched panel for durability. High-impact bakelite case with handle useable as instrument stand. Kit has simplified step-by-step assembly instructions. Both kit and factory-wired versions shipped complete with batteries and test leads. 5 1/4" H x 6 3/4" W x 2 7/8" D. 3 lbs.

Send FREE catalog of complete EMC line and name of nearest distributor.

RE-2

Name _____
Address _____
City _____
State _____ Zip _____

EMC

ELECTRONIC MEASUREMENTS CORP.
625 Broadway, New York, N.Y. 10012

interference. *Constructive interference* results from adding two wave amplitudes of the same sign (+ or -) (see Fig. 4A). *Destructive interference* results from adding two amplitudes of different signs (Fig. 4B).

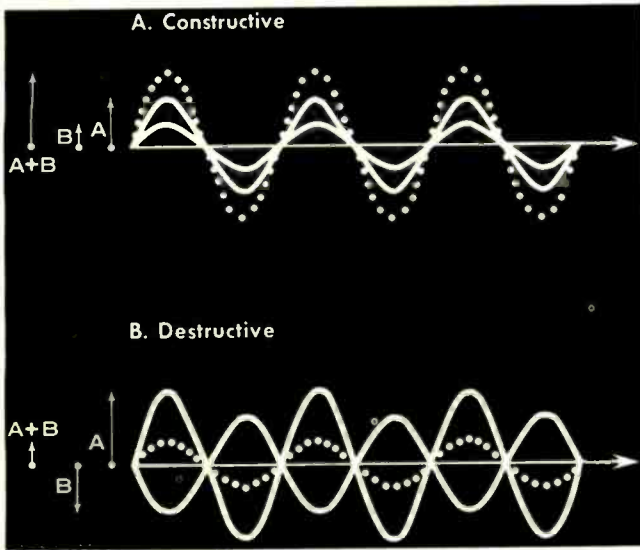

Fig. 4

Lateral coherence

Consider two waves traveling along the parallel lines of propagation, with equal amplitudes, wave lengths, and in phase (Fig. 5). Pick two points, one on each wave, and note

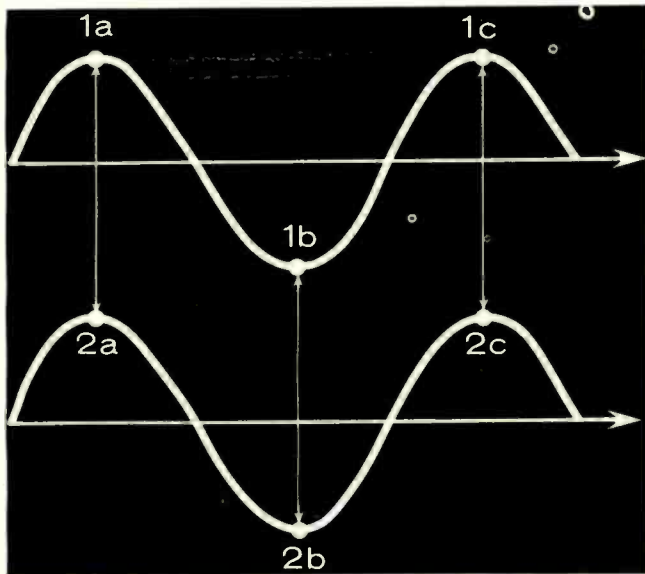

Fig. 5

what happens as the wave propagates. (It must be emphasized that only the positions of the points in a perpendicular direction to the line of propagation need be considered.) As the points move from a to b to c, the distance between them remains constant. The points are not only in phase along the path of propagation, but also in a direction perpendicular to the paths of propagation. Since these points are in phase perpendicular to the path of propagation, they are said to be *laterally coherent*.

Spatial coherence

The discussion has been limited thus far to a two-dimensional representation. However, light waves are three-dimensional, and the concept of coherence must be expanded to cover such a system.

The transition is simple. Temporal coherence remains the same along the direction of propagation as does lateral coherence, but now lateral coherence is allowed to relate to any direction perpendicular to the line of propagation.

The result of combining these two concepts, lateral and

temporal coherence, produces what is called spatial coherence in which two or more points are in phase a) along the direction of propagation (temporal); and b) along any direction perpendicular to the direction of propagation (lateral) (See Fig. 6).

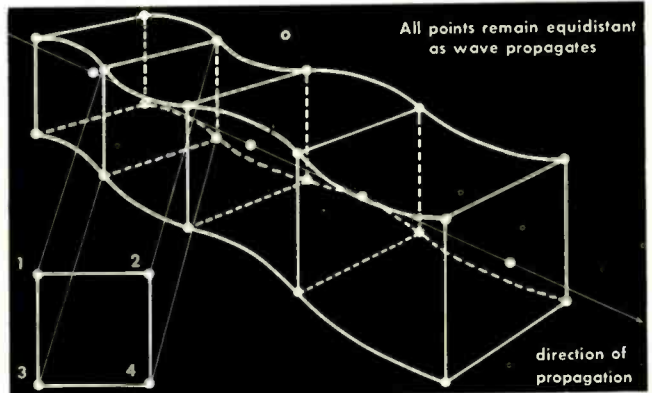

Fig. 6

Importance of coherence

One of the most startling consequences of coherent light was totally unexpected until the phenomenon was viewed for the first time during the operation of a continuous wave laser. This phenomenon is, of course, the speckled image produced when the highly coherent laser light is scattered from a semi-smooth diffuse reflector. Here we see diffraction and phase interference effects on a scale never attained before with visible light. What we see is really a stationary diffraction pattern in space resulting from the scattering of the coherent light by the diffuse reflector and the subsequent interference of the coherent wave trains with each other. The effect is enhanced by the high coherence so that the pattern extends to dimensions visible to the human eye.

R-E

10 CHANNELS SONAR-SCAN™

FM MONITOR RECEIVERS

EXCLUSIVE! *NOBODY CAN TOP THESE FEATURES!*

- ★ PRIORITY CHANNEL—LOCKS OUT ALL OTHER SIGNALS*
- ★ CARRIER DELAY—YOU HEAR MOBILE CALLBACKS*
- ★ MANUAL SELECTION BY SLOW SCAN TECHNIQUE*

A proven professional performer with the most advanced technology in design, circuitry and solid state electronics assures flawless performance you can hear with extreme clarity • SONAR-SCAN will search and automatically lock a signal on any of 10 pre-programmed channels • Noise free squelch • 10 crystal controlled channels • Adjustable scan sensitivity • Narrow band operation • 117 VAC or 12 VDC, negative ground only

FR-2516 (25-50MHz) FR-2517 (150-175MHz)
 Comes complete with AC and DC power cables, mounting bracket less crystals—Crystals \$5.00 ea.

\$159⁹⁵

EXCLUSIVE WITH SONAR and PATENT PENDING*

SONAR RADIO CORPORATION
 73 Wortman Avenue
 Brooklyn, N. Y. 11207

Send Information on Model FR-2516/17 SONAR-SCAN. Dept. 425

Name

Address

City..... State..... Zip.....

'No-Noise' Products Work Like Magic!

For Color and B/W

SUPER - LUBE

Concentrated formula for heavy duty jobs. Foams away corrosion, dirt, oxidation and polishes all tuners without drift or detuning. Avoid call-backs.

"No-Noise" products are guaranteed non-flammable, no carbon tet, non-toxic, safe for plastics.

Volume Control & Contact Restorer

Cleans, lubricates, restores volume controls, push button assemblies, band switches, relays and other electrical contacts.

Manufacturers of These Other Famous "NO-NOISE" Products:
Tuner-Tonic • EC-44 • Super Spray Bath
Frigid-Air • Tape-Recs Head Cleaner

Often imitated but never duplicated

ELECTRONIC CHEMICAL CORP.

813 Communipaw Avenue Jersey City, N. J. 07304

Circle 76 on reader service card

LIQUID CRYSTAL

(continued from page 36)

treat them with respect! Don't get any on your hands, eyes, or mouth. Clean up thoroughly when finished, and keep the chemicals away from children. Avoid getting any fumes (highly unlikely) in your eyes or mouth. In spite of the fact that liquid crystal chemicals appear harmless—treat them as dangerous chemicals. Better safe than sorry.

Before you start your display work, get as much printed information as you can, starting with manufacturer's literature from Tables I and II. Then read *Dynamic Scattering: A New Electrooptic Effect in Certain Classes of Nematic Liquid Crystals* by Heilmeyer, et al., in the July 1968 *Proceedings of the IEEE*, Vol 56, no 7, pp 1162-1171. You might also find pages 2146-2148 (December 1968) of interest, as well as pages 34-38 (January 1969) of volume 57. For more information beyond this, check the *Engineering Index* in your local library under *Crystals, Liquid*. This will generate a hundred or so papers, some of which you'll be able to pin down. Remember that nematic liquid crystals are most often the ones used in displays, while half the papers will deal only with thermal effects and cholesteric materials. R-E

TRANSISTOR TESTING IS A CINCH

(continued from page 39)

istor now shows good. No leakage, and npn (and, as you can see in Fig. 4-c, the "almost-standard" TO-5 basing or E-B-C counting clockwise around from the locator lug on the case.)

There was evidently too much shunt resistance somewhere to let the transistor test good in-circuit. This was in a little "gadget" I had picked up; I thought the transistors were good, and this one was.

In another test, on an all-channel TV booster, there was a definite suspicion that the transistor was bad. (I don't know what made me think that; maybe because it had been hit by lightning, and wouldn't work!) At any rate, there were a lot of low-resistance things hooked across the transistor; baluns, small resistors, and so on. Resistance readings were way off. However, I did note that the ohmmeter showed no diode-effect between base and emitter.

I took the transistor out and checked it on the tester, no good. The ohmmeter showed that the base-emitter junction was open. The collector-emitter junction still showed a diode-effect. From the low resistance indicated, this note that the ohmmeter showed no the ohmmeter was on the emitter. So, this was a pnp. I did note that what I was using as the collector lead was connected to the case.

The assumption turned out to be correct. Plugging the booster in, and checking the open-circuit dc voltage from the power supply showed 25 volts. So I chose a pnp germanium transistor, collector-voltage rating of 35 V, 800 MHz high-frequency cutoff, and tried it. It worked.

So even if the transistor is a complete stranger, with one junction completely open, you can still use these tests to get enough data to make a ball-park diagnosis of what it was, and select a replacement that has a chance of working. As a matter of fact, if you turn out to be wrong (as demonstrated by the indisputable fact that the thing *won't* work!), it doesn't seem to do any harm to a modern junction transistor to be installed *backward*.

Summation: I have only one suggestion now. Be sure to *try* these tests yourself, with your own equipment, and compare results. At first, use new (checked) transistors, and keep notes. Watch for the peculiar reactions of the two types of bipolar transistors, and remember them. I believe this will be very helpful!

Possibly some of you have your own methods of identifying and testing unknown transistors. If so, I'd like to hear from you. Perhaps we can get together and develop a "standard" test. R-E

BONUS SALE

NEW LOW, LOW PRICES

free 810 operational amplifier (dual) DIP w/data for all prepaid orders of \$10. or more. **\$1.25 value**

FREE 810 op-amp and one LM309K 5 volt 1 amp. power supply module (TO-3) with prepaid orders of \$25. or more. **\$3.75 value**

With prepaid orders for \$50. or more you get the \$25. bonus plus ten per cent discount on all items purchased.

EPOXY TRANSISTORS

Popular numbers, all factory-marked with 2N-type numbers. Guaranteed minimum of 40 pieces of TO-5 and TO-18 mixed. Untested, but sampling indicates over 85% good.

approximately 1-ounce—40+ transistors for only \$1.89

DIGITAL SPECIAL

Ten brand new (on carriers) dual-in-line JK flip-flops—LU321 with data sheet and two pages of application notes describing hookups for—divide by three through ten, and twelve. Also self correcting ring counter hookups, etc.

10 LU321 W/data \$5.00

DIGITAL COUNTER MODULE 30MC

unit includes board, SN7490, SN7475 quad latch, SN7447 7-segment driver and RCA "numitron" display tube W/decimal, 1" x 4.5" module will mount on 1" centers.

kit \$12—wired and tested \$15.

LINEAR IC's (dual-in-line)

709 operational amplifier	..50
710 voltage comparator	..75
LM309K 5V-1A power supply module	..2.50
LM100 positive voltage reg.	..80
747 dual 741 op amp DIP	..1.25

LINEAR SPECIAL

Ten (10) Teledyne TO-5 741 operational amplifiers with a two-page sheet of application notes covering the basic circuits using op-amps \$ 75 each

Op-amp package 10-741's, data sheet and application notes only \$7.00

LED Red Emitting Lamp

7491 8 bit shift register\$1.40	8242 4 bit comparator\$.90
7492 divide by 12 counter1.40	8280 preset decade counter1.40
7493 4 bit binary counter1.40	8281 preset binary counter1.40
74154 one of 16 decoder3.00	8520 25 MC divide by "N" 2 to 152.00
74192 up/down decade counter2.25	7495 4 bit SHIFTR REGISTER1.40
74193 up/down binary counter2.00	8590 8 bit shift register2.00
74195 univ. 4 bit Slt1.40	8270 4 bit shift register2.00
8220 parity gen/checker1.00		

TTL dual-in-line

7400, 7401, 7402, 7404, 7405, 7410, 7420, 7430, 7440, 7450, 7451, 7453ea. \$.30
7441 BCD decoder driver1.40
7442 BCD decoder1.40
7473 dual JK flip-flop65
7474 dual type D FF50
7475 quad latch1.40
7476 dual JK FF65
7480 gated full adder80
7483 4 bit full adder1.60
7488 quad exclusive or gate65
7490 decade counter1.40

BABYLON ELECTRONICS

SEND FOR FREE FLYER

P.O. Box 85
CARMICHAEL, CA. 95608
(916) 966-2111

Circle 77 on reader service card

try this one

MINI SOLDER POT HEATS IN MINUTES

How many times have you wished for a ready hot solder pot at hand as you tinned a dozen or so wires one at a time with an iron? Here is a miniature solder pot that fits into a regular solder-

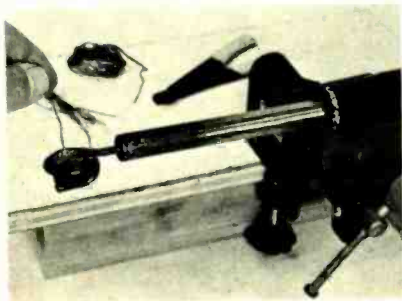

ing iron that heats up, ready to use, in only a few minutes.

The solder cup is an end cap for 1/2-

inch rigid copper tubing around which a copper wire is bent, as shown, forming a circle slightly smaller than the diameter of the end cap.

After forming the wire and checking for a tight fit thoroughly clean it and the outside wall of the cup with steel



wool or sandpaper. As the iron heats up for the first time apply solder to the copper wire and it will flow between the wire and the cup.

The wire used to support the cup should be soft copper (preferably solid)

of the same diameter as the soldering-iron tip it replaces. A No. 2 or 3 wire is about right for a 1/4-inch tip.

With care lightly shake the iron (wear safety glasses!) to get rid of excess solder. What's left will form a near perfect heat transfer, hot or cold, insuring a quick warm up of the solder that now can be put in the pot.

For safety and to free both hands, use a bench stand or a small vise to hold the iron. This is a case where an ounce of prevention, by way of the stand, is well worth a pound of trouble that the lead on the loose would surely be.—
Gene Cabot

R-E

If electrolytic capacitors are your nemesis, you won't want to miss the article starting on page 58. It's called "All About electrolytics," and once you've read it you shouldn't have any questions left.

audio signal generator

PARTS LIST

- 1 HEP 310 or 2N5871 unijunction transistor
- 1 180 ohms, 1/2 watt, 10% resistor
- 1 200,000-ohm potentiometer
- 1 47,000 ohms, 1/2 watt, 10% resistor
- 1 0.5-μF, 25-volt capacitor
- 1 Key (for code practice)
- 1 Set headphones (or speaker)
- 1 0.01-μF, 25-volt capacitor (optional, needed only for signal generator)
- 1 9-volt battery

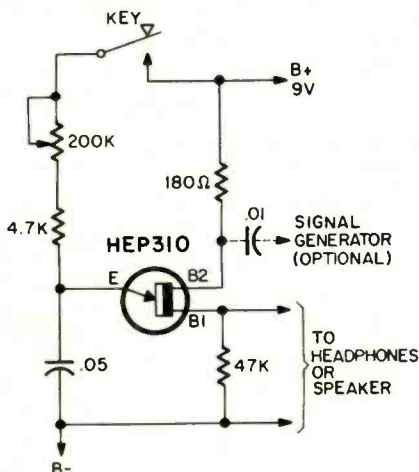

A unijunction relaxation oscillator can be used for many purposes simply by changing a few components, as illustrated by this one-transistor project. It can generate an audio signal for troubleshooting amplifiers or for practicing code. The frequency is adjustable and the oscillator can be used with headphone or speaker. The signal generator output provides a pulse output with high harmonic content. For a clarinet-like sound, take the output signal from the emitter of the unijunction transistor.

R-E

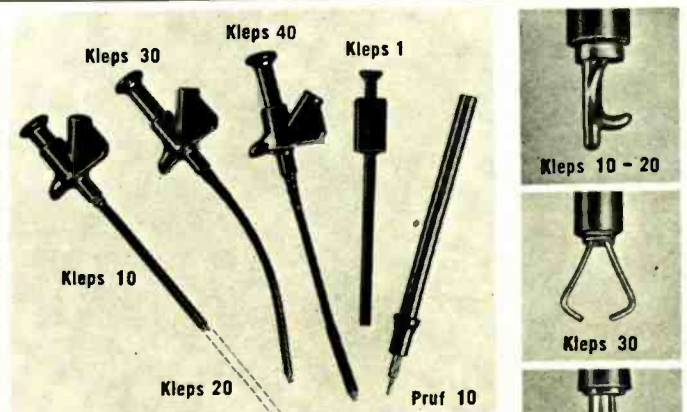

Clever Kleps

Test probes designed by your needs—Push to seize, push to release (all Kleps spring loaded).

- Kleps 10.** Boathook clamp grips wires, lugs, terminals. Accepts banana plug or bare wire lead. 4 3/4" long. \$1.19
 - Kleps 20.** Same, but 7" long. \$1.39
 - Kleps 30.** Completely flexible. Forked-tongue gripper. Accepts banana plug or bare lead. 6" long. \$1.47
 - Kleps 40.** Completely flexible. 3-segment automatic collet firmly grips wire ends, PC-board terminals, connector pins. Accepts banana plug or plain wire. 6 1/4" long. \$2.39
 - Kleps 1.** Economy Kleps for light line work (not lab quality). Meshing claws. 4 1/2" long. \$.99
 - Prof 10.** Versatile test prod. Solder connection. Molded phenolic. Doubles as scribing tool. "Bunch" pin fits banana jack. Phone tip. 5 1/2" long. \$.79
- All in red or black—specify. For additional information, write for complete catalog of—test probes, plugs, sockets, connectors, earphones, headsets, miniature components.



Available through your local distributor, or write to:
RYE INDUSTRIES INC.
127 Spencer Place, Mamaroneck, N.Y. 10543
In Canada: Rye Industries (Canada) Ltd.

Circle 78 on reader service card
FEBRUARY 1972 • RADIO-ELECTRONICS 91

ELECTRONIC TECHNICIANS!

Raise your professional standing and prepare for promotion! Win your diploma in

ENGINEERING MATHEMATICS

from the Indiana Home Study Institute

We are proud to announce two great new courses in Engineering Mathematics for the electronic industry.

These unusual courses are the result of many years of study and thought by the President of Indiana Home Study, who has personally lectured in the classroom to thousands of men, from all walks of life, on mathematics, and electrical and electronic engineering.

You will have to see the lessons to appreciate them!

NOW you can master engineering mathematics and actually enjoy doing it!

WE ARE THIS SURE: you sign no contracts—you order your lessons on a money-back guarantee.

In plain language, if you aren't satisfied you don't pay, and there are no strings attached.

Write today for more information and your outline of courses.

You have nothing to lose, and everything to gain!

The INDIANA HOME STUDY INSTITUTE

Dept. RE-2, P.O. Box 1189, Panama City, Fla. 32401

Circle 79 on reader service card

EQUIPMENT REPORT

(continued from page 84)

(C7, L3, C8, C9) and only the lower difference-frequency signals are passed. The first af amplifier feeds through the volume control to three cascaded af voltage amplifiers. The receiver's selectivity (2 kHz at -6-dB points) is quite adequate for most amateur communications.

Two paralleled diodes protect the mixer transistor against possible damage by very strong rf signals and induced voltage from electrical storms.

The ANTENNA TUNE control tunes L2 on 80 and 40 meters. On 20 15, L1 is switched across L2 to low the effective inductance of the antenna circuit and permit it to be tuned to the higher frequencies.

The oscillator circuit is rather unusual. On 80 meters L5 and L6 are in series and the main tuning capacitor is between ground and the oscillator emitter. The buffer, an emitter follower, feeds the signal to the mixer. On 40 meters, only L5 is tuned and the MAIN TUNE capacitor is moved to a capacitive tap to provide the correct bandsread tuning for that band and the ones above it. When receiving on 20 and 15 meters, the oscillator tunes from 7.0 to 7.3 MHz

SPECIFICATIONS

Frequency range: 3.5-4.0 MHz
7.0-7.3 MHz
14.0-14.6 MHz
21.0-21.9 MHz

Modes of operation: USB, LSB, AM, CW

Sensitivity: Less than 1 μ V for readable signal

Stability: Less than 100 Hz drift, no warm-up

Audio output: 3 volts across 1000 ohms

Antenna impedance: 50-70 ohms unbalanced

Selectivity: 2 kHz at -6 dB points

and the multiplier is cut into the circuit to double or triple the oscillator frequency as needed.

Ten-Tec has a set of three PC modules (VO-1 oscillator, MX-1 mixer and AA-1 audio oscillator that can be interconnected to make a receiver similar to the RX-10. By adding to this, the TX-1 crystal oscillator and 2-watt rf amplifier module, you will have a low-power ham-band transceiver.



"Pssst! Looking for a bargain?"

AR guarantees its published specifications

At Acoustic Research we believe that the publication of complete performance data on our high fidelity components is obligatory. Otherwise, our guarantee would have little meaning.

Find out just what AR guarantees that its products will do. Mail the coupon below, and detailed technical literature will be sent to you free of charge.



Acoustic Research, Inc.
24 Thorndike Street
Cambridge, Mass. 02141
Dept. RE-2

Please send measured performance data on AR products to

Name _____

Address _____

EDI

THOUSANDS OF BARGAINS—TOP VALUES IN Electronic Parts

Translators, Modules, Speakers, Stereo, HI-FI, Photo Cells and thousands of other Electronic Parts. Send for **FREE** Catalog



ELECTRONIC DISTRIBUTORS INC.
Dept. TA-2, 4900 Elston
Chicago, Ill. 60630

RUSH CATALOG

Name _____

Address _____

City _____ State _____ Zip Code _____

Circle 80 on reader service card

Circle 81 on reader service card



"Highy, you've got to find a better way to cure your hiccups."

SONY KV-1710

Residual buzz in this color set is caused by hum or noise in the deflection circuit. After replacing the SC board, use the following procedure to eliminate the buzz:

1. Move the grounding point of the GRY/WHT shielded wire connected between the volume control and terminals 12 and 13 on the SC board as shown in Fig. 1.

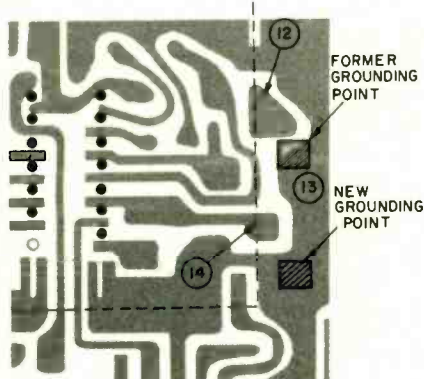

Fig. 1

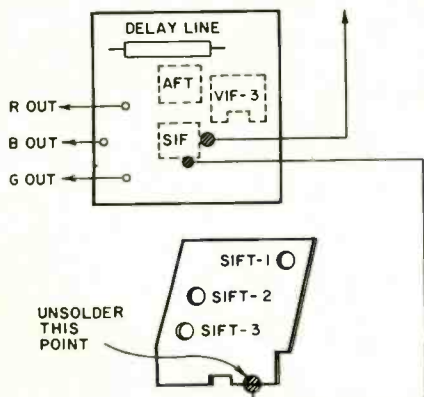

Fig. 2

2. Unsolder the single ground point for the SIF shield case as shown in Fig. 2.—*Sony Service Supplement*

RCA CTC 46 SERIES

The output impedance of the MAN sound output module is relatively high (32-35 ohms) compared to other current color chassis. When bench servicing is required, make certain a lower impedance (4-8 ohms) test speaker is *not* used since this can result in damage to the MAN module components.—*RCA Service Information*

3CU3 HV RECTIFIER

Some late Magnavox color TV chassis use a 3CU3 high-voltage rectifier tube and a 3A3 should never be tried as a substitute. The 3CU3, a directly heated type, has a posted filament design that prevents the possibility of a broken fila-

ment from contacting the tube anode. The 3A3 does not provide this protection.

The 3CU3 has a faster warm-up time and receivers using it may display the picture before the automatic degaussing action is completed. **DO NOT** use a 3A3 to delay the picture and thus conceal the degaussing action.—*Magnavox Service News Letter*

LINEARITY CONTROL REPLACEMENT

When a vertical linearity control (usually a wire-wound pot) burns out an exact replacement may not be available. While an ordinary wire-wound pot may be substituted I've found that a 3-watt fixed wire-wound resistor may be used. The resistance required for good linearity can be found by substituting. The height control can be used to fill the screen vertically.

I used this scheme in an RCA KCS146 b-w chassis.—*Paul Galluzzi*

Do you know what liquid-crystals are all about? If not turn back to page 33 right now and read Don Lancaster's article on Liquid Crystal Displays. It opens the door to a whole new corner of electronic devices.

BIRTH
DEFECTS
ARE
FOREVER

...unless you help.
give to the
MARCH OF DIMES

THIS SPACE CONTRIBUTED AS A PUBLIC SERVICE BY THE PUBLISHER

AMPEREX READOUT TUBE

Brand new
\$3.00 ea.
10/\$25.00

**COUNTING PACKAGE**

Amperex Tube
SN 7490
SN 7441

All above \$6.75

NIXIE TUBE POWER SUPPLY

From used eqpmt. OK.
115V input, solid state.
\$4.95

GIANT NIXIES

\$3.00 each, 10/\$25

Magnificent alpha-numeric 15 segment nixies. Display full alphabet plus numbers 0-9, all in one tube 4 1/2 inches high with 2 1/2 inch characters. 170 volt operation, make unusual clocks, displays, games, etc.



#7971 \$3 each 10/\$25. Sockets 50¢ each

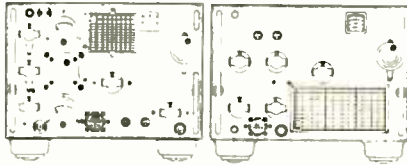

TCS receiver & transmitter. 4 channel crystal or tuneable. 1.5 thru 12 mc. Collins design, gov't surplus, xint cond. No conversion required. Simple make a power supply, data included. Receive foreign broadcast, amateur, time signals, short wave, marine. Either rcvr or xmtr at \$40 or both for \$75.

MM500 Dual 25 bit shift register	\$2.50
MM502 Dual 50 bit shift register	3.50
MEM 511 MOS P-channel FET	1.00
1 amp diode 1000 PIV	8/1.00
1 amp diode 1500 PIV	4/1.00
2 amp diode 1000 PIV	6/1.00

Please add postage for above items
Send 25¢ for Surplus Catalog . . .

JOHN MESHNA JR. ELECTRONICS
P.O. Box 62 E. Lynn, Mass. 01904

Circle 97 on reader service card

ANOTHER SUPERB VALUE from Olson Electronics



ONLY
\$28
DELUXE WIRELESS INTERCOM

Save steps, keep in touch with this compact two-station intercom. Needs no cable. Just plug into any AC outlet in your home wiring system and talk between them. Can continuously monitor baby's room, sickroom or any desired location.

Olson Electronics, Dept. L2
260 S. Forge St., Akron, Ohio 44308

- I enclose \$28, plus \$1 for postage and handling. Send me the AM-366 Wireless Intercom.
 Send me the next seven issues of the Olson Catalog, without cost or obligation. **FREE**

Name _____
Address _____
City _____
State _____ Zip _____

Circle 84 on reader service card

market center

HIGH FIDELITY

DISCOUNTS: All stereo equipment. Request Quotes: **NEWPORT AUDIO**, 50 Newport Drive, Hewlett, N.Y. 11557

HI-FI system designed especially for you. Professional help in choosing your components. Write: **DONALD DAUGHTERY**, 5754-N Backlick, Springfield, Va. 22150

MAKE YOUR OWN SPEAKER SYSTEMS. SAVE 1/2 THE COST. WRITE FOR CATALOG. MCGEE RADIO COMPANY, 1901 MCGEE STREET (RE), KANSAS CITY, MO. 64108

TAPE & RECORDERS

RENT 4-track open reel tapes—all major labels—3,000 different—free brochure. **STEREO-PARTI** 55 St. James Drive, Santa Rosa, Ca. 95401

MEMOREX recording tape, audio & video lowest prices, write for free information. **BERGETZ SYSTEMS CO.**, Box 1181, Melrose Park, Ill. 60161

HONEYWELL COMPUTER BOARDS

Honeywell Computer boards, 4 1/2" x 12". Transistors, diodes, zeners, capacitors, precision resistors, heat sinks, trimmers etc. 2 Different boards \$1.00. Stock No. J9082.

COMPUTER GRADE CAPACITORS

J2062 40,000 mfd. 10 volts 3 1/4" x 4 1/4" 1.25 ea. 6/7.00
J2118 70,000 mfd. 10 volts 3 1/4" x 4 1/4" 1.75 ea. 6/9.00
J2117 6,000 mfd. 55 volts 2 1/2" x 4 1/4" 1.50 ea. 7/9.00
J2116 3,750 mfd. 75 volts 2 1/2" x 4 1/4" 1.75 ea. 6/9.00
All above are brand new and include terminal hardware.

PHOTO ELECTRIC ASSEMBLIES

H7000



H7001

H7000
Contains cadmium sulfide photo cell, potentiometer, relay, lamp & Fairchild 2N2657. 1 1/2" x 1 1/4". original used as exposure meter control. Complete with circuit diagram & application data . . . \$1.25

H7001
Contains cadmium sulfide photocell, 2-500 JL variable resistors, & Fairchild 2N2240. Change in light changes bias on transistor. Useful for all types of light sensing & alarm devices75 ea.
3 ea. H7000 & H7001 5.00

\$1.00 FREE WITH \$10.00 ORDER
MINIMUM ORDER \$3.00

Lots of other items—send for free flier; all merchandise fully guaranteed. Please include postage; excess will be refunded.

DELTA ELECTRONICS CO.
BOX 1, LYNN, MASSACHUSETTS 01903

Circle 85 on reader service card

FIRST BREAKTHROUGH IN RECORDING TAPE. Originally made by America's leading tape manufacturer **2400' MYLAR**, 7" reel, \$2.29; **1800' MYLAR**, 7" reel, \$1.69; **1200' ACETATE**, 7" reel, \$.79. Write for quantity prices. **AAE**, 218 Columbia St., Utica, N.Y. 13502

ELECTRONICS ENGINEERING & INSTRUCTION

TV TUNER REPAIRS—Complete Course Details, 12 Repair Tricks, Many Plans, Two Lessons, all for \$1. Refundable. **FRANK BOCEK**, Box 3236 (Enterprise), Redding, Ca. 96001

COMMUNICATIONS CONSULTANT—F.C.C. Licensed-Commercial, Amateur, C.B. **THEODORE AHRENS**, 21 Poplar Street, Bloomingdale, N.J. 07403

FCC "TESTS-ANSWERS" . . . Original exam manual for F.C.C. First and Second Class License—plus—"Self-Study Ability Test." Proven! \$9.95. Satisfaction Guaranteed. **COMMAND** Box 26348-E, San Francisco, Ca. 94126



USE THIS HANDY DANDY STORAGE IDEA!



Handy Dandys are plastic caps that hook onto 1/8" pegboard and hold quarter-twist jars, such as popular food jars with 1 1/4" neck. Nothing better for storing components, workshop supplies, parts, small tools conveniently. Sample pack, caps only: 10-\$1 • 36-\$3.50 • 72-\$6 • 144-\$11.50. Unbreakable, clear plastic jars only: 10-\$2 • 24-\$4.50 • 36-\$6.25 • 72-\$11.50 • 144-\$22 • 500-\$72. Ppd. U.S.A. No C.O.D.'s. **WICKLIFFE INDUSTRIES, INC.**, Box 286 RE-2 Wickliffe, Ohio 44092.

GET INTO ELECTRONICS

V.T.I. training leads to success as technicians, field engineers, specialists in communications, guided missiles, computers, radar and automation. Basic & advanced courses in theory & laboratory. Electronic Engineering Technology & Electronic Technology curricula both available. Associate degree in 29 mos. B.S. also obtainable. G.I. approved. Graduates in all branches of electronics with major companies. Start Sept., Feb. Dorms. campus. High school graduate or equivalent. Catalog. **VALPARAISO TECHNICAL INSTITUTE**
Dept. C, Valparaiso, Indiana 46383

**YEATS appliance dollies**

MOVE 'EM EASY with a **YEATS dolly**



DeLuxe Model No. 14 \$89.50
ORDER YOURS TODAY! FREE illustrated brochure

Yeats Appliance Dolly Sales Co.
1301 W. FOND DU LAC AVE.
MILWAUKEE, WIS. 53205

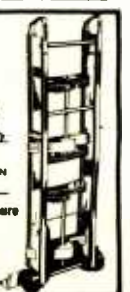

IMPOSSIBLE? BARGAINS IN SURPLUS ELECTRONICS AND OPTICS

B & F ENTERPRISES — WE SCOOP THE COMPETITION

SURPLUS TTL INTEGRATED CIRCUITS, BRAND NEW IN ORIGINAL MANUFACTURERS CARTONS



DIP

B & F has one of the worlds largest inventories of surplus integrated circuits. All are new, meeting all manufacturers original specifications, and in factory packaging. The low prices should speak for themselves. Manufactured by Texas Instruments, National, Signetics or Philco, no choice. All packages are 14/16 lead silicone Dual In-Line Pak.

NEW LOWER PRICES!

404		954		\$1.75			
7400	7409	7450	7406	7470	7413	7480	74141
7401	7410	7451	7407	7472	7442	7483	74151
7402	7411	7453	7416	7473	7443	7480	
7403	7420	7454	7417	7474	7444	7484	
7404	7421	7460	7426	7486	7475	7485	
7405	7430		7437	74121	7476	7486	
7408	7440		7438	74122	7477	74107	

\$2.00	\$2.50	\$2.75	\$3.75	\$5.75	\$8.75	
7448	7445	7441	74150	7485	74166	7489
7491	7447	7491	74152	74182	74198	74170
7492	7448	74123	74153		74199	74181
7493	7483		74154			2501
74180	74145		74192			
	74194		74193			

HOT NEW INTEGRATED CIRCUIT ITEMS!

7413	Dual NAND Schmidt Trigger	\$ 1.75
7485	Magnitude Comparator	3.75
74123	Dual One Shot W/clear	2.75
74153	Dual 4 Line to 1 Data Selector/multiplexer	3.75
7489	64 Bit Random Access Memory	9.75
74170	4 x 4 Register File	9.75
74181	Arithmetic Logic Unit	9.75
74182	Look Ahead Carry Generator	3.75
2501	256 Bit MOS Random Access Memory	9.75
74166	Parallel In Series Out Synch Shift Reg.	5.75
74198	8 Bit Shift Reg., Shift Right/left	5.75
74199	Same as 74198	5.75
2513	MOS 64 x 7 x 5 ASCII Character Generator — generates 64 alpha-numeric characters on a 5 x 7 matrix of lamps (on a CRT)	\$25.00

20% discount on all orders for 100 or more integrated circuits. All I.C.'s postpaid, with FREE air mail on orders over \$50.00. We strive to ship I.C.'s by return mail. Free data sheets on all items.

DIGITAL CLOCK KIT WITH NIXIE DISPLAY



We have well over 20,000 surplus nixies in stock, and because of this bargain purchase we can sell a complete digital clock kit for less than the usual cost of the display tubes only. We provide

a complete etched and thru-plated circuit board, all integrated circuits, complete power supply, display tubes, I.C. sockets and a nice front panel with polaroid visor. We have never seen anyone offer this kit for less than \$100.00 before. Includes BCO outputs for use as with timer option. May be wired for 12 or 24 hour display. Indicates hours, minutes, seconds.

- Clock Kit, complete less outside cover \$57.50
- Aluminum blue or black anodized cover (specify) \$ 4.50

BRIDGE RECTIFIERS MOLDED EPOXY

- 1/2 amp 200 volt \$0.50
- 1/2 amp 400 volt 0.75
- 1 amp 200 volt 0.75
- 1 amp 400 volt 1.00
- 1 amp 600 volt 1.25
- 4 amp 200 volt 1.50
- 4 amp 400 volt 1.75
- 10 or more mixed or matched, 20% discount.

SANKO AUDIO AMPLIFIERS



We have made a fortunate purchase of Sanko Audio Amplifier Hybrid Modules. With these you can build your own audio amplifiers at less than the price of discrete components. Just add a power supply, and a chassis to act as a heat sink. Brand new units, in original boxes, guaranteed by B and F, Sanko and the Sanko U.S. distributor. Available in three sizes: 10 watts

RMS (20 watts music power), 25 watts RMS (50 watts M.P.) and 50 watts RMS (100 watts M.P.) per channel. 20 page manufacturers instruction book included. Sanko amplifiers have proved so simple and reliable, that they are being used for industrial applications, such as servo amplifiers and wide band laboratory amplifiers.

- 10 Watt RMS Amplifier \$ 4.75
- 25 Watt RMS Amplifier \$14.75
- 50 Watt RMS Amplifier \$22.50

You may have noticed that our competitors are mimicking our product lines, sometimes even our advertising copy! We don't mind, not only because imitation is the sincerest form of flattery, but because we have a whole bag of surprises, including items you might have thought were only a gleam in some engineer's eye (witness the "calculator on a chip", phase locked loops). B and F is dedicated to supplying the electronics enthusiast with the most advanced technology, at prices that are "impossibly low". How do we do this? By putting our head on the chopping block! For instance one purchase of integrated circuits was over 250,000 pieces, representing more than the total inventory of most of our competitors.



SPECIAL! SHARP MODEL EL8A CALCULATOR

The response to last months offer of the Sharp QT-8 calculator was overwhelming, and within a short period of time we exhausted their entire stock so that this model is no longer available. Because of this unprecedented response, Sharp has offered B & F a special quantity purchase on the model EL8A, which is the new pocket size version of the QT8. We can offer this model at only a few dollars more than the

QT8, a remarkable buy at only \$192.50.

Don't forget, you can charge this, as well as other items to Mastercharge or BankAmericard. Fully guaranteed by Sharp and B & F.

- Sharp electronic calculator, model EL8A \$192.50

TEXAS INSTRUMENTS LIGHT EMITTING DIODES (LED's)

Use as logic readouts, either on panel or right on cards. Infinite life.

- 2 for \$ 1.50
- 10 for 7.00
- 100 for 50.00

OPERATIONAL AMPLIFIER SUPPLY

±15 volts @ 100 milliamps. Brand new, 115 VAC input, manufactured by Analog Devices, similar to their model 902. List price \$49.00, our price \$32.50.

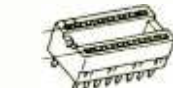

ROPER = 5 J PUNCH

Whitney Roper =5 J punch, brand new with all punches and dies. We guarantee this punch will be one of the most used tools in your toolbox. Wish we could afford the time and space to tell you how handy we have found these to be for light production. Takes one tenth the time of drilling. Include shipping for five pounds, not postpaid \$14.50



- NIXIE— READOUT DECADE COUNTER KIT, including 7490 and 7441 integrated circuits, readout tube, complete etched circuit and instructions. Would you believe \$8.95 (Add \$2.00 for 7475 latch)
- Burroughs 5441 tube and socket only Price \$4.75
- Amperex B1000R tube only Price \$2.95

HIGH VOLTAGE POWER SUPPLIES

We have 1200 of these. At 15 pounds each the floors are groaning. Help clear them out at our bargain price. Provides +5000 volts, -6500 volts, 5000 volts A.C. at 1.5 milliamps each seems to be regulated. Weighs 15 pounds. Definitely not postpaid, include shipping \$9.00

BRAND NEW AM/FM RADIOS



Mfg. by Delco for 1969 Pontiac. This would have cost \$170.00 when you bought your car, but you can buy them now for \$32.50. Use them in car, boat, camping trailer. Weight 10 lbs., not postpaid. A great buy. \$32.50

- AM/FM Radio \$32.50
- AM only \$17.50

FEATURE ITEM!



This succession of devices portrays the evolution of active components necessary for implementation of an 8000 calculator. In 1969 the effort required dozens of bipolar devices. By 1970 the same calculator could be produced using only four MOSFET devices and now it has been implemented on a single 1802 LSI chip.

Texas Instruments TMS-1802 "Calculator on a Chip". This is tomorrow's technology today, and at a fraction of list price. This calculator logic unit consists of a 3,520 bit read-only program memory, a 182 bit random memory, a decimal arithmetic logic unit, plus timing, control, and output decoders. The features are: eight digits • four operations • three registers • floating or fixed point decimal • constant or chain operations • automatic rounding • leading zero suppression • internal keyboard encoding and debouncing • decoded display outputs • single phase clock operations • 28 pin DIP package • internal power on clear.

Every TM-1802 is a brand new Texas Instruments factory packaged, fully guaranteed unit. The only devices required to build a calculator are a battery, clock generator, keyboard, display drivers, and eight digits of display, all available from B & F. Full schematics, specifications and instructions from T.I. are included.

- Texas Instrument TMS 1802 Calculator Chip \$29.00
- Texas Instruments keyboard \$19.00
- T.I. SN25391, SN26392 Drivers, 4 required .1 for \$ 3.00
- All parts for clock generator \$ 4.75
- Readouts, eight required .1 for \$ 3.50
- Complete package, except battery \$88.00

7 SEGMENT READOUTS

7 Segment Readouts. Two types are available, a large size model with wire leads for P.C. Board Mounting illustrated at (A) and a small size low-current version in a Dual In-Line type package for miniature battery operated instruments illustrated at (B).

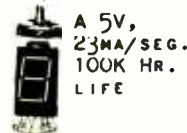

- Large Size Readout (Illus. A) \$3.95
- Low Current Version (Illus. B) \$3.75
- Complete counter kit, including 7490 decade counter, 7447 decoder and printed circuit board, and choice of either readout. Price \$8.75
- Complete counter as above, with 7475 latch, for storage. Price \$10.75



- Complete Bi-directional counter, with 74192 instead of 7490, for up-down counting \$11.75
- Complete Bi-directional counter, with latch for storage (74192-7475-7447) \$12.75

- NE 567 phase locked loop, with full instructions for touch tone decoding \$ 5.00
- NE566 phase locked loop, with full instructions for touch tone generation \$ 5.00

Moltex termopoint connections for I.C.'s. With these you can build low cost I.C. sockets by just cutting off the number of connections required, i.e., two strips of seven for 14 pin socket.

- 500 Molex 1938-4 Solderconcs \$ 4.75
- 1 ampere 5 volt regulated power supply for I.C.'s \$12.50
- 3 ampere, 5 volts regulated \$24.50
- 5 ampere, 5 volts regulated \$29.50
- 3 amp, 5 volts regulated and +200 volts for Sperry and Nixie displays \$34.50

- Polaroid circular polarized red plastic for LED, Nixie and lamp displays, piece 1 1/4" x 6" \$ 1.50

- 80 PAGE CATALOG - Free with any order or send \$0.25

ALL ITEMS (WHERE WEIGHT IS NOT SPECIFIED) POSTAGE PAID IN THE U. S. A.

Charges Welcome: BankAmericard - Mastercharge - \$10.00 min.

B. & F. ENTERPRISES

Phone (617) 532-2323

P.O. Box 44, Hathorne, Massachusetts 01937

Circle 86 on reader service card

market center

FOR SALE

B & K, Sencore test equipment, discount prices. Free catalog and price sheet. FORDHAM RADIO, 265 E. 149th St. Bronx, N.Y. 10451

FREE Electronics magazines list \$1.00. ELECTRONIC PUBLICATIONS, DEW-50, Wainwright, Ak. 99782

200 MILE TV RECEPTION? YES- with CADCO equipment. Free catalog. CADCO SYSTEMS, Box 18904, Oklahoma City, Ok. 73118

CLASSIFIED COMMERCIAL RATE (for firms or individuals offering commercial products or services). 90¢ per word . . . minimum 10 words.

NONCOMMERCIAL RATE (for individuals who want to buy or sell personal items) 60¢ per word . . . no minimum.

FIRST WORD and NAME set in bold caps at no extra charge. Additional bold face at 10¢ per word. Payment must accompany all ads except those placed by accredited advertising agencies. 10% discount on 12 consecutive insertions, if paid in advance. Misleading or objectionable ads not accepted. Copy for April issue must reach us before Feb. 1

TELEVISION Broadcasting Employment Information: "How to Break In," \$2.00 I.Q. ENGINEERING, Box 374, Canoga Park, Ca. 91305

SPECIAL Clearance Sale: Rectifiers, Transistors, small motors, electronic parts. Lowest Prices. Free Catalog. GENERAL SALES COMPANY, (713-265-2369) 254 E. Main St., Clute Tx. 77531

MEMORIES SEMICONDUCTORS FREE FLYER, UTI, P.O. Box 252, Waldwick, N.J. 07463

RESISTORS, capacitors, Telephones, parts. Brochure. COMET COMMUNICATIONS, Dept. "R" 639-50th Street, Brooklyn, N.Y. 11220

SPECIAL 30 DAYS SUPER SALE!

We have to order IC's for our manufacturing and retail requirements on March 1, 1972. In order to be able to bargain for high-volume prices, we must reduce our \$5,000 IC inventory. To take advantage of these low, low prices, YOUR ORDERS MUST BE POSTMARKED ON OR BEFORE FEB. 25, 1972. We promise you, come March 1st, everyone's IC prices (including ours) will be higher.

TTL DIGITAL IC'S		LINEAR IC'S	
7400, 7401, 7402, 7403, 7410, 7420, 7430, 7440, 7450, 7451, 7453, 7454, 7460) Each.....	27¢	7495 4-Bit RIGHT-SHIFT, LEFT-SHIFT	\$1.39
7404, 7405, 7408, 7409, 7411, 7421).....	30¢	7496 5-Bit SHIFT REGISTER.....	\$1.35
7406 Hex Inverter, 30V, 40mA, Driver.....	68¢	74100 8-Bit LATCH.....	\$1.95
7407 Hex Buffer, 30V, 40mA, Driver.....	68¢	74107 Dual J-K M/S Flip-Flop.....	83¢
7413 Dual NAND Schmitt Trigger.....	66¢	74121 ONE-SHOT Multivibrator.....	77¢
7416 Hex Inverter, 15V, 40mA, Driver.....	58¢	74122 Retriggerable ONE-SHOT w/CLEAR.....	86¢
7417 Hex Buffer, 15V, 40mA, Driver.....	58¢	74123 Dual Retr. ONE-SHOT w/CLEAR.....	\$1.38
7426 Quad 2-Input High Voltage NAND.....	49¢	74145 BCD-to-DECIMAL Decoder/Driver.....	\$1.45
7438 Quad 2-Input NAND Buffer.....	66¢	74145 BCD-to-DECIMAL Decoder.....	\$1.45
7441 BCD-to-DECIMAL Decoder/Driver.....	\$1.33	74150 16-Line to 1-Line MULTIPLEXER.....	\$2.00
7442 BCD-to-DECIMAL Decoder.....	\$1.25	74151 8-Line to 1-Line MULTIPLEXER.....	\$1.37
7443 Excess 3-to-DECIMAL Decoder.....	\$1.28	74153 Dual 4-Line to 1-Line MULTIPLEXER.....	\$2.13
7444 EXCESS 3-GRAY-to-DECIMAL Decod.....	\$1.28	74154 4-Line to 16-Line DEMULTIPLEXER.....	\$2.00
7445 BCD-to-DECIMAL Decoder/Driver.....	\$1.59	74155 Dual 2-Line to 4-Line DEMULTIPLEXER.....	\$1.71
7446 BCD-to-7-Segment Decoder/Driver.....	\$1.52	74157 Quad 2-Line to 1-Line MULTIPLEXER.....	\$1.91
7447 BCD-to-7-Segment Decoder/Driver.....	\$1.52	74176 PRESETTABLE DCADE COUNTER.....	\$2.04
7448 BCD-to-7-Segment Decoder/Driver.....	\$1.44	74177 PRESETTABLE 4-Bit BINARY COUNTER.....	2.04
7470 GATED J-K Flip-Flop.....	65¢	74180 8-Bit ODD/EVEN Parity Gen/Check.....	1.67
7472 GATED J-K M/S Flip-Flop.....	65¢	74181 4-Bit ARITHMETIC/LOGIC UNIT.....	\$7.50
7473 Dual J-K M/S Flip-Flop.....	60¢	74182 LOCK-TRIP/ARM CARRY GENERATOR.....	\$1.63
7474 Dual D-Type Edge-Triggered F.F.....	60¢	74192 DECADE UP/DOWN COUNTER.....	\$2.70
7475 Quad LATCH.....	\$1.15	74193 4-Bit BINARY UP/DOWN COUNTER.....	\$2.70
7476 Dual J-K M/S Flip-Flop.....	62¢		
7480 GATED FULL ADDER.....	90¢		
7483 4-Bit Binary FULL ADDER.....	\$1.58		
7486 Quad 2-Input EXCLUSIVE-OR Gate.....	77¢		
7489 64-Bit READ/WRITE MEMORY (RAM).....	\$6.85		
7490 DECADE COUNTER.....	\$1.18		
7491 8-Bit Shift Register.....	\$1.45		
7492 Divide-by-12 COUNTER.....	\$1.18		
7493 Divide-by-16 COUNTER.....	\$1.18		
7494 4-Bit SHIFT REGISTER.....	\$1.39		

ALL IC'S ARE IN DUAL-IN-LINE PACKAGES, EXCEPT #540 WHICH IS IN 10-PIN TO-5 PACKAGES. We give FREE IC data sheets upon request. So, ask for those data sheets that you NEED, even for those IC's that you are not buying. On orders over \$50.00, we'll send you a new 150-page COMPLETE TTL IC data book, FREE!

OUR NEW CATALOG LISTING A COMPLETE LINE OF BRAND NEW ELECTRONIC PARTS AND SERVICES IS AVAILABLE NOW. WRITE FOR IT, OR CIRCLE READER SERVICE CARD.

TOLEX IC SOCKET PINS. DON'T SOLDER YOUR IC'S TO PCB BOARDS. USE THESE ECONOMICAL SOCKET PINS. SOLD IN STRIPS IN MULTIPLES OF 100 PINS ONLY. PRICE PER 100.....\$1.00

**LM-335, 5V, 600mA \$2.85
LM-336, 12V, 500mA \$3.85
LM-337, 15V, 450mA \$4.05
INTERNAL-SET, OVERLOAD AND SHORT-CIRCUIT PROOF VOLTAGE REGULATORS. HAVE FOLD-BACK CURRENT LIMIT. I.B.G. NEED NO EXTERNAL COMPONENTS TO SET. HIGH DATA SHEET & APPLICATION NOTE.**

SPANCOR P-8180, 25.2 VOLT, 1-AMP TRANSFORMER, IDEAL FOR USE WITH LM-SERIES. \$2.65

ALLEN-BRADLEY MIL-GRADE (5-BAND) RESISTORS. 1/4 OR 1/2 WATT. ANY VALUE FROM 2.70 TO 22MΩ. Min. 2 per value. EACH.....4¢

SEVEN-SEGMENT DISPLAY. FITS IN A DIP SOCKET OR SOLDER DIRECTLY TO PCB BOARD. BATED FOR PER SEGMENT AT TTL SUPPLY OF 5 VDC. DESIGN LIFE OF 50,000 HOURS FOR LIMITED TIME ONLY. EACH.....\$3.25

TERMS: RATED FIRMS NET 30 DAYS. OTHERS CASH OR CHECK WITH ORDER. ADD 35¢ FOR POSTAGE AND HANDLING TO ORDERS UNDER \$5. MISSOURI RESIDENTS ADD 4% SALES TAX.

Solid State Systems, Inc. P. O. BOX 773, COLUMBIA, MO. 65201 PHONE: 314-443-3673

Independent News Company, Inc. is pleased to announce a Retail Display Plan which includes Radio-Electronics as part of a group of magazines available for the earning of a Display Allowance.

To obtain details and a copy of the formal contract please write to Marketing Department, Independent News Co., Inc., 909 Third Avenue, New York, N.Y., 10022 (Attention Mr. Paul Hendershot). Under the Retail Display Plan in consideration of your acceptance and fulfillment of the terms of formal contract to be sent to you upon request you will receive a Display Allowance of 10% of the cover price per copy of each magazine in the group sold by you. This plan will become effective with all issues of the magazine group delivered to you subsequent to the date your written acceptance is received and accepted by our Company.

U.S. GOV'T ELECTRONIC SURPLUS

Nationally Known-World Famous SURPLUS CENTER offers finest, most operative, Government Surplus electronic units and components at a fraction of their original acquisition cost.

IBM COMPUTER POWER SUPPLY

(ITEM #22-824) -- Expensive, regulated unit. Fine for college labs, research work, service shops, etc. Pure DC over a wide range of voltages. DC output voltages 6, 12, 18, etc. Wide range of AC voltages available.

Finest transformers, filter, transistor load regulation system independent of line voltage fluctuations. Contains five separate rectifier systems. Unit is furnished without small "regulating card" which can be easily made or can be by-passed. Data and circuit diagrams furnished. 30" x 12" x 10". (125 lbs.)

Cost Gov't Over \$500.00

\$24.95

ONCE-IN-A-LIFETIME SPECIAL



BURGLAR-FIRE ALARM SYSTEM



(ITEM #1135-A) -- Dual alarm system gives warning of fire or break-in. Operates on 115-VAC. Control unit, 2-Kilohm fire, 2-mercury column, 3-door window actuator for local intercom system. Full instructions are furnished. Wt. 9 lbs.

\$29.95

STANDARD DIAL TELEPHONE



(ITEM #718) -- Standard, commercial telephone made as used throughout U.S.A. Attractive polished black. In new condition. Has an extension phone to private systems or connect several phones together for local intercom system. Full instructions are furnished. Wt. 9 lbs.

Original Cost **\$7.49**

STEP-BY-STEP TELEPHONE SWITCH



(ITEM #7-808) -- Amazing telephone selector switch. Great additional item. When used with two-wire telephone dial will select any number from 0 to 100. Make intercom or private system. Use to turn on remote lights, start motors, etc. Complete with contact bank. 13" x 6" x 5". (16 lbs.) Cost Over \$90.00

\$6.29

Telephone dial for use with above switch. Order as (Item #700)..... **\$1.97**

MAGNETIC DIGITAL COUNTER (12 to 18-VDC)



(ITEM #21-858) -- Use to count electrically. Use to count number of times door is opened after business is closed to show changing prices, laboratory uses, etc. Will count 1 for each pulse and will transfer 10th count to next unit. 4 1/2" x 1 3/4" x 1 1/4".

(1 1/4 lbs.)

Orig. Cost Over \$18.00 Each **\$1.99** Three For **\$4.99**

200 AMP., 50 VOLT, SILICON DIODE

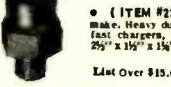

(ITEM #22-933) -- A Four Star Buy! New, leading make. Heavy duty unit excellent for use in 12 or 24-volt fast chargers, high current power supply systems, etc. 2 1/2" x 1 1/2" x 1 1/4". 3/16-16 SAE mounting threads. (1 lb.)

Last Over \$15.00

\$4.99

AC PROGRAM TIMING CLOCK

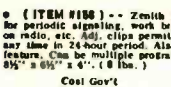

(ITEM #186) -- Zenith 115-VAC unit. Use for periodic signaling, work breaks, classes, turn on radio, etc. Add. clips permit ON-OFF switching any time in 24-hour period. Also has "skip-a-day" feature. Can be multiple programmed. 8 1/2" x 6 1/2" x 4". (8 lbs.)

Cost Gov't Over \$30.00

\$15.75

SNAP AROUND VOLT-OHM-AMMETER



(ITEM #21-844) -- Measures AC current without opening the line. Simply press handle and snap the probe around the conductor. Reads currents from 25 to 125-megs. Reads voltages to 300, reads ohms up to 500. Test motors, appliances, etc. Three current ranges, two voltage ranges. With case, test leads. 7 1/4" x 3" x 1 1/4".

\$36.90

Reg. Price \$39.95 (2 lbs.)

SPECIAL SALE Correspondence Course in ELECTRICAL ENGINEERING



(ITEM #A 100) -- Obtain technical training at low cost! Lincoln Engineering School has suspended its Correspondence Course because of rising costs. A limited number of Electrical Engineering Courses are available, but without the examination grading service. The course consists of 15 lesson books, each with associated exams and standard answers. Book describing free winning Home Experimental Laboratory Bench furnished at no extra cost.

\$8.79 Prepaid in U.S.A.

\$10.79 Outside U.S.A.

RUNNING TIME METER

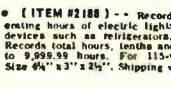

(ITEM #2188) -- Record number of operating hours of electric lights and electrical devices such as refrigerators, furnaces, etc. Records total hours, months and hundredths up to 9,999.99 hours. For 115-volt, 60-cycle. Size 4 1/2" x 3 1/2" x 2 1/2". Shipping weight 2 lbs.

\$4.39

Cost Over \$29.00

COMPUTER TRANSISTORS ON HEAT SINKS

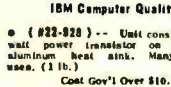

IBM Computer Quality Units

(#22-828) -- Unit consists of one 150-watt power transistor on heavy ribbed aluminum heat sink. Many experimental uses. (1 lb.)

Cost Gov't Over \$10.00

\$1.99



(#22-819) -- Unit consists of one 150-watt power transistor, 2 pos. electrolytic capacitors, resistors, etc. on heavy ribbed aluminum heat sink. Ideal for use as motor speed control. (4 lbs.)

Cost Gov't Over \$35.00

\$4.91

All items shipped f.o.b. Lincoln, Nebr.

Order Direct From Ad. Money Back Guarantee.

SURPLUS CENTER

Dept RE-022 Lincoln, Nebr. 68501

Circle 82 on reader service card

T.V. SERVICEMEN Original Replacement Parts, Japanese, American Tubes, Transistors, Dealer Discounts. **MARCUS**, 43-35 44th St., Long Island City N.Y. 11104

METERS REPAIRED, calibrated. Free precision resistor. Complete details, send name, address to: **MEASURING INSTRUMENTS SERVICENTER** 1770 W. Flagler St., Suite #5, Phone: 649-7001 Miami, Florida 33135

ELECTRONIC ORGAN KEYBOARDS, OSCILLATOR COILS, PRINTED CIRCUITS AND OTHER COMPONENTS FOR ORGAN CIRCUIRY. 20 CENTS FOR BROCHURE. **DEVTRONIX ORGAN PRODUCTS**, 5872 AMAPOLA DRIVE, SAN JOSE, CA. 95129

FREE CATALOG New Electronic Devices! World's Smallest Transmitter \$19.95! Telephone Answerer \$49.50! Telephone Recording Device \$19.95! "Bug" Detector \$59.50! Many more! **SONIC DEVICES**, 69-29R Queens Blvd., N.Y. 11377

IGNITION. 250:1 Coil, Ballast \$7.95. Free lists. **TRANSPARK**, Carlisle, Mass., 01741

INVENTIONS & PATENTS

INVENTIONS WANTED, Patented; Unpatented. **GLOBAL MARKETING**, 2420-AE 77th Ave., Oakland, Ca. 94605

TUBES

RECEIVING & INDUSTRIAL TUBES, TRANSISTORS, All Brands—Biggest Discounts. Technicians, Hobbyists, Experimenters—Request **FREE** Giant Catalog and **SAVE!** **ZALYTRON**, 469 Jericho Turnpike, Mineola, N.Y. 11501

SAVE MONEY ON PARTS AND TRANSMITTING-RECEIVING TUBES, FOREIGN-DO-MESTIC. SEND 25¢ FOR GIANT CATALOG. REFUNDED FIRST ORDER. **UNITED RADIO COMPANY**, 56-R FERRY STREET, NEWARK, N.J. 07105

TV-2/U DYNAMIC MUTUAL CONDUCTANCE ELECTRONIC TUBE TESTER



For portable use. Gov't. surplus unit used to test and measure performance capacities, and to determine rejection limits for electron tubes used in receivers, low powered transmitters and other electronic equipment. Has provisions for checking tubes up to 9 pins including Acorn, Notal, 7 Pin Trans, etc. Meters 2 1/2" for reading Fil., Grid, Plate, Screen, Signal and transconductance (percent quality) which is 10,000 ohms per volt. All the important tests can be made on this unit. Also it will test tubes under actual operating conditions by setting the proper voltages on the meters. Power Req.: 115 volts, 60 cycle. Size: 17 1/2" x 16 1/2" x 8 1/2". Wt.: 45 lbs. Prices: Used, serviceable: \$55.00 Checked: \$65.00

TS-382 AUDIO OSCILLATOR



Frequency range 20 to 200,000 CPS in four bands. output imp. 1000 ohms. amplitudes continuous variable 0-10 volts: Freq. response 20 CPS to 150,000 CPS; approx. ±1 DB; Freq. accuracy ±6%; stability ±2%; Hum 60 DB below rated output; attenuator accuracy 3% except 10 Micro. V ±2 or -3 Microvolts. Power input 115 V. 50-1600 cyc. Output 100 MW. With nine tubes, calibrated tuning dial, freq. range switch, output level cont. output level attenuator, signal input and output jack, output level meter, vibrating reed-type meter used as accuracy check of the osc. calibration. Size: 18 1/2" x 10" x 12 1/2". Ship. Wt.: 75 lbs. Prices: Used, serviceable: \$75.00 Checked: \$85.00 All Prices are F.O.B. Lima, Ohio. Address Dept. RE Send Now For Our CATALOG 72

FAIR RADIO SALES

10 1/2 E. EUREKA • Box 1105 • LIMA, OHIO • 45802

INTEGRATED CIRCUITS & RECTIFIERS SEMICONDUCTORS & TRIACS

We can supply Japanese transistors, rectifiers, and SCR's in quantity. Phone or send type numbers or specifications
2N3819 General purpose N-Channel FET'S \$.45

PROGRAMMABLE UJT's similar to D13T with data sheet \$.75

VARIABLE CAPACITANCE DIODES, (similar to 1N5463A) used to tune VHF, Color TV & FM broadcast sets\$1.00

ER900 TRIGGER DIODES. These bidirectional trigger diodes are one of the best and cheapest methods to trigger SCR's and triacs .4/\$1.00

Visible MLD 600 LED\$1.20

MRD 14B photo darlington\$.75

TRIACS

PRV	1A	10A	15A	20A*
100	.40	.70	1.00	1.20
200	.70	1.10	1.40	1.60
300	.90	1.35	1.80	2.00
400	1.10	1.60	2.20	2.40
500	1.50	2.00	2.60	2.80

*Press fit

NIXIE TUBES
Similar to Raytheon 8754 with socket & data sheet \$3.00

TTL IC SERIES
7441 BCD DECIMAL DECODER\$1.75
7475 QUAD BISTABLE LATCH\$1.40

7476 DUAL JK MASTER-SLAVE JK FLIP FLOP \$1.00

7490 DECADE COUNTER \$1.50

7492 DIVIDE BY TWELVE \$1.85

7481 16 BIT MEMORY ELEMENT\$2.00

7404 HEX INVERTERS\$.40

7447 BCD TO SEVEN DECODER DRIVER\$2.00

74121 MONOSTABLE MULTIVIBRATOR ..\$.90

14 Pin DIP sockets3 for \$1.00

Silicon Power Rectifiers

PRV	3A	12A	30A
100	.09	.24	.40
200	.12	.28	.60
400	.16	.35	.90
600	.20	.50	1.10
800	.28	.70	1.40
1000	.35	.90	

DECADE COUNTER KIT
CONSISTING OF:
1—NIXIE TUBE and SOCKET
1—7490 1—7475 1—7441
Specially priced at \$7.50

Controlled Avalanche or Epoxy Rectifiers 1 AMP.

PRV	PRV
100 .06	600 .11
200 .07	800 .15
400 .09	1000 .20

LINEAR CIRCUITS

709C operational Amp ..\$.70
741 operational Amp ..\$1.00
SE 501 Video Amp\$1.00
723 Voltage regulator ..\$1.25
Silicon Control Rectifiers

PRV	3A	7A	20A	70A
50	.25	.28	.60	
100	.30	.38	.85	3.50
200	.50	.60	1.10	6.50
300	1.60	.68	1.30	
400	.70	.75	1.50	9.50
500	.80	.85	1.70	
600	.90	1.20	1.90	11.00

Terms: FOB Cambridge, Mass. Send check or Money Order. Include Postage. Average Wt. per package 1/2 lb. No. C.O.D.'s. Minimum Order \$3.00

Send for our fall catalog featuring Transistors and Rectifiers; 325 Elm St., Cambridge, Mass.

OLID

Post Office Box 74D

TATE

Somerville, Mass. 02143

ALES

Tel. (617) 547-4005

Circle 93 on reader service card

Semiconductor Supermart

• MOTOROLA • RCA • FAIRCHILD • NATIONAL • HEP •



DIGITAL READOUT
At a price everyone \$3.70 can afford

- Operates from 5 VDC
- Same as TTL and DTL
- Will last 250,000 hours.

SPECIAL OFFER

- Digital readout
- BCD to 7—Segment Decoder/driver
- 7490 Decade Counter Only \$8.50

SUPER BUYS

- 709 Op. Amp .70
- 741 Op. Amp \$1.25
- 723 V. Reg. \$1.75
- Zener 9 V .50
- Zener 12 V .50
- Zener 5 V .50

Part No.	Description	Price
MC1550	Motorola RF amp	\$1.80
CA3020	RCA 1/2 W audio	\$3.07
CA3020A	RCA I audio	\$3.92
CA3028A	RCA RF amp	\$1.77
MC1306P	Motorola 1/2 W audio	\$1.10
MC1350P	High gain RF amp/ 1F amp	\$1.15
MC1357P	FM IF amp Quadrature det	\$2.25
MC1496	Hard to find Bal. Mod	\$3.25
MFC 9020	Motorola 2-Watt audio	\$2.50
MFC 4010	Multi-purpose wide-band amp.	\$1.25
MFC 8040	Low noise preamp	\$1.50
MC1303P	Dual Stereo preamp	\$2.75
MC1304P	Fm multiplexer stereo demod	\$4.95

TRANSISTORS

Part No.	Description	Price
MPF102	JFET	\$.60
MPF105/2N5459	JFET	.96
MPF107/2N5486	JFET VHF/UHF	\$1.26
MPF121	Low-cost dual gate VHF RF	.85
MFE3007	Dual-gate	\$1.98
2N5188		.79
3N140	Dual-gate	\$1.95
3N141	Dual-gate	\$1.86

MOST MOTOROLA, FAIRCHILD, RCA, HEP & NATIONAL INTEGRATED CIRCUITS, FET'S OTHER TRANSISTORS AVAILABLE. WRITE WITH YOUR NEEDS.

HEK-2 FET EXPERIMENTERS KIT Contains HEP-801, HEP-802, HEP-50, HEP-51 and Instructions for 9 Projects \$3.95

INSTANT CIRCUIT BOARDS
Instant Circuit Boards—NO ETCH—NO MESS—NO FUSS CIRCUIT-STIK is a complete system of component subelements and materials designed to work together to produce instant circuit boards that are as durable as regular circuit boards. CIRCUIT-STIK ELIMINATES: drilling, photo work, and etching. Just stick the pressure sensitive sub-elements down on pattern G Vectorboard. They stick down firmly, withstand soldering temperatures, yet can be picked up and moved for circuit changes. In fact, they make building projects with integrated circuits and transistors a real breeze. Sub-elements are available for 8, 10, and 12-lead IC's, dual in-line IC's, all transistors, plus pressure sensitive copper tape, etc. Applications data available. Starter Packet Assortment \$5.50. Super Packet \$7.95.

Please add 35¢ for shipping

CIRCUIT SPECIALISTS CO.

Box 3047, Scottsdale, AZ 85257
FACTORY AUTHORIZED
HEP-CIRCUIT-STIK
DISTRIBUTOR

Circle 94 on reader service card

ADVERTISING INDEX

RADIO-ELECTRONICS does not assume responsibility for any errors which may appear in the index below.

READER SERVICE CARD NO.	PAGE
81	Acoustic Research..... 92
61	Alarm Device Mfg. Co..... 71
13	Allied Radio Shack..... 32
69	Allied Radio Shack..... 82
77	Babylon Electronics..... 90
86	B&F Enterprises..... 95
15	B & K, Division of Dynascan Corp..... 63
74	Brooks Radio & TV Corp..... 86-87
64	Chemtronics, Inc..... 74
14	Cleveland Institute of Electronics..... 46-49
70	Cook's Institute of Electronics Engineering..... 82
	CREI, Division of the McGraw-Hill Continuing Education Co..... 18-21
85	Delta Electronics, Co..... 94
17	Delta Products, Inc..... 69
62	Edlie Electronics, Inc..... 72
87	Edmund Scientific Co..... 100
67	Edsyn Inc..... 76
76	Electronic Chemical Corp..... 90
80	Electronic Distributors, Inc..... 92
73	EICO, Electronic Instrument Co..... 85, 86, 87
	EMC, Electronic Measurements Corp..... 88
10	Enterprise Development Corp..... 22
11	Grantham School of Engineering..... 23
	GTE Sylvania Electronic Components..... 13, 15
100	Heath Co..... 78-81
79	Indiana Home Study Institute..... 92
16	International Crystal Mfg. Co..... 68
3	Jerrold Electronics..... 2
9	E. F. Johnson..... 22
66	Lafayette Radio Electronics..... 75
7	Lectrotech, Inc..... 17
12	Lee Electronic Labs, Co..... 24
4	Mallory Distributor Products Co..... 5
2	McGraw-Hill Book Co..... 1
65	National Camera Co..... 74
	National Radio Institute..... 8-11
	National Technical Schools..... 28-31
83	Nelson-Hershfield Electronics..... 94
84	Olson Electronics..... 94
5	Phase Corp..... 7
72	Precision Tuner Service..... 84
	RCA Institutes..... 64-67
78	Rye Industries, Inc..... 91
88	Sams and Co., Howard W..... Cover III
63	Schober Organ..... 73
1	Shure Brothers, Inc..... Cover II
75	Sonar Radio..... 89
89	Sony Corp. of America..... Cover IV
6	Telex..... 16
8	Tescom Corp..... 22
71	TV Tech Aids..... 83
68	Unimetrics..... 77
	MARKET CENTER..... 94-99
94	Circuit Specialists
	Fair Radio Sales
95	Environmental Products
97	John Meshna Jr. Electronics
96	Polypaks
98	Polypaks
93	Solid State Sales
82	Solid State Systems
	Surplus Center
	Wickliffe Industries, Inc.
	Yeats Appliance Dolly Sales Co.
	SCHOOL DIRECTORY..... 94
	Valparaiso Technical Institute

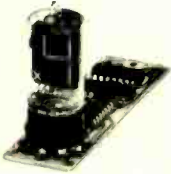

UNIVERSAL DCU/DRIVER

This universal decade counter and seven segment display driver module is rated at up to 15V and 40mA per segment. It will drive most incandescent and all LED displays. Count rate 20MHz typ. PC board measures 1" x 3 1/2". Uses 3 TTL IC's. Any number may be cascaded.

NR-3 Universal Counter/Driver ... \$8.75
[LESS READOUT - OTHER MODULES AVAILABLE]

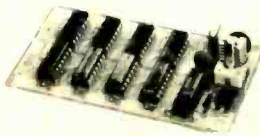

CRYSTAL FREQUENCY STANDARD

Contains a .002% crystal oscillator with decade dividers to give TTL compatible outputs of 10, 1MHz, 100, 10, 1kHz, 100, 1, & 0.1Hz. Kit operates from 5 volt supply requiring 175mA. Great for freq meters, clocks, etc. Included are zero beat trimmer and G-10 PC board.

CR0-10 Crystal Freq Standard ... \$21.95

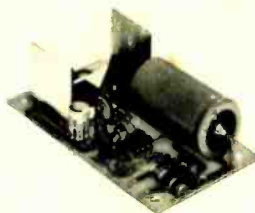

LOGIC SUPPLY REGULATOR

Both kits have an output range of 3.3V to 5.0V with current limiting and short circuit protection. Regulation is 1% and the ripple & noise is 10mV RMS. G-10 is the board material.

DPS-1A Output Current 0.6A \$6.95
DPS-2A Output Current 2.2A 9.95

TR100 TRANSFORMER FOR DPS-1A .. \$2.25
TR500 TRANSFORMER FOR DPS-2A .. 5.95

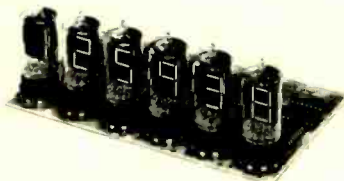

This universal 12 hr. digital clock has all the counting and decoding necessary to display seconds, minutes, and hours on any 7 segment display requiring up to 15V and 40mA per segment. PC board is 3 1/2" x 6". Requires 5V supply. Kit supplied with all parts & instructions.

NR-3CK Digital Clock \$39.95



- [] LED-2 Small lamp for miniature displays or logic indicator (A)
- [] LED-50 Popular pill package(B)
- [] LED-5020 Larger lamp for front panel indicator use. (A)

3/\$2.00 10/\$5.00 100/\$45.00



LED

Electrically and physically identical to the popular MAN-1. Has higher light output than MAN-1. Includes LH decimal point. W/spec sheet & app information.

LED700 7 Segment LED Display \$7.95
[QUANTITY DISCOUNTS AVAILABLE]

LSI

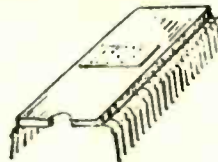

Build several instruments with this chip and little else. First really useful LSI chip for experimenters. Contains:

- * Four Decade Counters + Overrange
- * Four 4 Bit Latches
- * Seven Segment Decoder
- * Display Multiplexing Circuitry
- * Two Programmable Oscillators
- * Operates from single 5V supply
- * Inputs TTL compatible
- * Housed in 28 pin Dual In-line pak
- * Great for DVM's, Freq Meters, etc.

Comes with 9 p. booklet of specs & app notes. Booklet contains interfacing info on all seven segment displays made.

5002 LSI Chip \$26.95

5005 Booklet on 5002 only 1.50



RAM

The 1101 Random Access Memory (RAM) will store and readout 256 bits. The chip is TTL compatible and comes with a complete spec sheet w/applications.

1101 256 Bit RAM \$8.95

ZENER DIODES 1 Watt 5%

1N4728A	3.3 Volt	1N4735A	6.2
1N4729A	3.6	1N4736A	6.8
1N4731A	4.3	1N4742A	12
1N4732A	4.7	1N4744A	15
1N4733A	5.1	1N4749A	24

3/\$1.00

CORE MEMORY DIODES

Sylvania GY Diodes .. 10/\$1.00 100/\$4.95

POWER DIODES

1N4004 400PIV 1 Amp 5/\$1.00

epd ENVIRONMENTAL PRODUCTS BankAmericard - master charge
BOX 406 LAFAYETTE, IN 47902 \$10.00 MIN 317-743-1893

Circle 95 on reader service card

BRAND NEW! *Guaranteed!*
LINEAR IC AMPS *W/Spec Sheets*

Type	Description	Sale	3 for	\$3.00
703 RF-IF, 14 hookups, TO-5		\$1.19	3 for	\$3.00
709C Operational Amp***		.59	2 for	1.00
710C Differential Amp***		.59	2 for	1.00
711C Memory, Sense, Amp***		.59	2 for	1.00
723A Voltage Regulator (DIP)		1.49	3 for	3.75
TVR-2000 Hi-power 723 (DIP)		1.59	3 for	3.95
741C Freq. Comp. 709***		.95	3 for	2.50
748C Freq. Adjustable 741***		.95	3 for	2.50
709-709 Dual 709's (DIP)		1.49	3 for	4.00
741-741 Dual 741's (DIP)		1.98	3 for	5.50
749-749 Stereo Preamp (DIP)		1.98	3 for	5.50

*** State 1st, 2nd choice, Dual In Line, TO-5.

GIANT SALE ON NEW TTL TEXAS & NATIONAL ICs

Buy Any 3 — Take 10% Discount!

*Factory Tested! *Factory Guaranteed!

Type	Function	Sale
SN7400N	Quad 2 input NAND gate	.39
SN7401N	SN7400 with open collect	.39
SN7402N	Quad 2 input NOR gate	.39
SN7404N	Hex inverter, open collect	.39
SN7405N	Hex inverter, open collect	.39
SN7410N	Triple 3 input NAND gate	.39
SN7420N	Dual 4 input NAND gate	.39
SN7430N	8 input NAND gate	.39
SN7440N	Dual 4 input NAND buffer	1.50
SN7441N	BCD-to-Decimal driver	2.25
SN7446N	BCD-to-7 seg. dec./driver	2.25
SN7447N	BCD-to-7 seg. dec./driver	2.25
SN7472N	J-K Master slave flip-flop	.69
SN7473N	Dual J-K Master slave flip-flop	.88
SN7474N	Dual D triggered flip flop	.69
SN7475N	Quad bistable latch	1.50
SN7476N	SN7473, with preset-clear	.88
SN7481N	16-bit memory (scratch pad)	1.50
SN7483N	4-bit binary full adder	2.25
SN7490N	Decade counter	1.50
SN7491N	8-bit shift register	1.50
SN7492N	Divide by 12 counter	1.50
SN7493N	4-bit binary counter	1.50
SN7494N	4-bit shift register	1.50
SN7495N	4-hit register right-N-left	1.50
SN74154N	Divide by 16	3.45
SN74181N	Arithmetic Logic Unit	8.50
SN74192N	Bi-directional counter	3.45
SN74193N	Binary up-down counter	3.45

6-AMP FULL WAVE BRIDGES

PRV	SALE	400	1.50
50	\$.88	600	1.75
100	.99	800	1.95
200	1.25	1000	2.25

EPOXY SILICON RECTIFIERS

PIV	2Amp*	2Amp	3Amp	\$1.00
50	\$.05	\$.06	\$.12	
100	.07	.07	.15	
200	.07	.07	.15	
400	.09	.09	.22	
600	.12	.12	.28	
800	.15	.15	.39	
1000	.18	.18	.45	

*microminiature

ALLEN BRADLEY'S "MICRO-POTS" Any 2 for \$1

Type G, 1/2" dia. x 1/2" high. Mounts 1/4" hole, with shaft, linear, immersion-proof high freq.



Ohms	Ohms	Ohms	Ohms	Ohms
100	1.0K	10K	100K	1 Meg.
250	2.5K	25K	250K	2 Meg.
500	5.0K	50K	500K	5 Meg.

FETS, UJTS, VARACTORS, NIXIES

5 — Varactor diodes, 10, 20, 30, 40, 50 pF	\$1.00
1 — "PUT" Programmable unijunction	1.00
2 — 2N3370 FET, N channel TO-18, metal	1.00
2 — 2N2608 FET, P channel TO-18, metal	1.00
2 — 2N2646 Unijunction, plastic	1.00
5 — ER-900 Trigger diodes, scr's, triacs	1.00
2 — 2N3277 FET, P channel, metal TO-5	1.00

COUNTING SYSTEM

4-Pc. Kit **\$6.99**

Includes SN7490 decade counter, SN7441 BCD decoder-driver, SN7475 quad latch with hookups instructions with tube



ALLEN BRADLEY'S "TRANSISTOR" POTS Any 2 for \$1

Type F, Screwdriver, adjust.

Ohms	Ohms	Ohms	Ohms	Ohms
100	500	2.5K	20K	100K
200	1.0K	5.0K	25K	200K
250	2.0K	10K	50K	250K

15¢ CATALOG on Fiber Optics, 'ICs', Semi's, Parts

Terms: add postage. Rated: net 30, cod's 25¢

Phone Orders: Wakefield, Mass. (617) 245-3R29

Retail: 211 Albion St., Wakefield, Mass.

POLY PAKS P.O. BOX 942 R
Lynnfield, Mass. 01940

RADIO & TV Tubes 33¢ each. One year guaranteed. Plus many unusual electronic bargains. Free Catalog. CORNELL 4217-E University, San Diego, Ca. 92105

TUBES Receiving Factory Boxed, Low Prices, Free Price List. **TRANSELETRONIC, INC.** 1306 40th Street, Brooklyn, N.Y. 11218 Telephone 212-633-2800.

PLANS AND KITS

CONVERT any television to sensitive big-screen oscilloscope. Only minor changes required. No electronic experience necessary. Illustrated plans \$2.00. **RELCO-A25**, Box 10563, Houston, Tx. 77018

COLOR ORGAN KITS \$7.50. IC's \$25. Catalog. **MURPHY**, 204 Roslyn Ave., Carle Place, N.Y. 11514

LINEAR AMPLIFIERS: Build your own 250 Watts, 10-15 Meter Linear. Plans \$1.00 **ROBERTS** Box 8791 Fort Lauderdale, Fla. 33310

WANTED

QUICK CASH . . . for electronic EQUIPMENT, COMPONENTS, unused TUBES. Send list now! **BARRY**, 512 Broadway, N.Y. 10012, 212 WALKER 5-7000

BUSINESS OPPORTUNITIES

JAPANESE NEW PRODUCTS MONTHLY! \$1.00. Refundable. **DEERE**, 10639 Riverside, North Hollywood, Ca. 91609

MEDISTAT

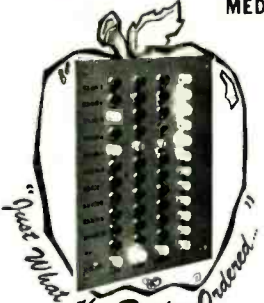

"Just what the Doctor Ordered"

The Physician Finder

In the modern medical clinic, the physicians and staff frequently get "lost" in the maze of examination, consultation and treatment rooms. The **MEDISTAT** is a simple flashing light system that informs office staff the location of doctors and key personnel. With six color lamps available for individual or operational identification, a **MEDISTAT** annunciator located by the door of each examining or consultation room tells the story of that room's occupancy and condition from moment to moment. The central annunciator tells receptionist or nurse the status and occupancy of all rooms in the clinic. **MEDISTAT** works independently or harmonizes with the **MEDICOM** communications system. For more information write, wire or call,

Nelson-Herskfeld Electronics

1848 WEST CAMPBELL AVE
PHOENIX, ARIZONA 85015

WESTINGHOUSE AM-FM SOLID STATE TUNER

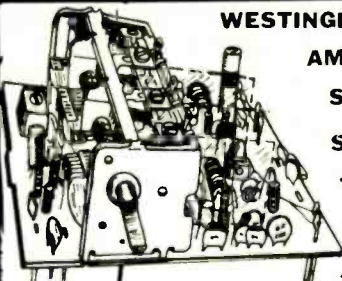

\$3.88
3 for \$10.

Tunes FM 88-108 mhz & AM 550 to 1600 kcs bands. Sensitive, compact (2 1/4 x 2 1/4 x 1 1/2" module). Can be used with 10.7 mc & 455 kcs IF strips and any hi-fi amplifier. Printed circuit, wired. 4 gang variable, supply voltage 9V 6-mils. Varactor diode for AFC. With schematics.

MEMORIES!

IBM 4000 Bit core plane, from computer #1401. **\$9.95**

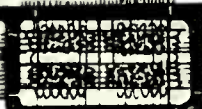

"PIK-A-PAK" FACTORY IC KITS

From Factory To You! • No Test! • With Diagrams!

24-709, 710, 711, 723, 741 asst. cases	\$2.98
24-7400 Series, Dual in line, asst.	1.98
24-Linear & 7400 Series, asst. cases	1.98
3-723 Type, voltage regulator, TO-5	1.00
10-709, 710, 711, 723, 741, TO-5	1.00
6-709, 741's, Dual in line	1.00
6-710 III Speed differentials, asst. case	1.00
6-711 Memory, sense, asst. cases	1.00
15-711 Memory, sense, flat paks	1.00
2-SN7481, hobby, up to 16 cell memories	1.00
3-SN7481, up to 16 cell memory, flat pak	1.00
2-SN7441, hobby, BCD to Nixie, Dip pak	1.00

TELEDYNE-FAIRCHILD 16-TRANSISTOR STEREO PRE-AMP "IC" **\$2.49**



LOW NOISE! Type 739, 8 transistor per channel. For magnetic stereo phone and tape recording devices. 50K input imp., 20,000 input gain. Provides RIAA band shape. Supply volts: 6 to 18V. Dual In Line package. Specs, diagrams.

"VISIBLE" LIGHT EMITTING DIODES



Micro mini, axial lead . . . \$.88 2 for \$1.45
Jumbo, TO-18, 2 leads red . . . 1.00 2 for 1.75

7-SEGMENT ALPHA-NUMERIC LED READOUT



\$6.50 3 for \$18.

0-9 numbers and 9 letters. Compatible with SN7446 and SN7447 7-segment BCD IC drivers. Snaps into dual in line sockets. Only 3/4 x 1/4 x 1/8". Specs: 5V 20-mils.

18 TRANSISTOR IC "BEEP" GENERATOR **\$1.98**

By Motorola — micro-miniature! Designed for photographic "audible timing alarm". Excellent generator of square waves. Use for intrusion, burglar, and fire alarms. Complete with instructions, schematics.

50 WATT HIGH POWER ZENERS

Volts	Volts	Volts	Volts
6.8	22	47	100
8.2	27	56	120
10	33	68	150
12	39	82	150

\$1.49 3 for \$3.75

FAIRCHILD'S POPULAR "IC" TWINS — RTL914 & RTL923

epoxy TO-5 case **75¢**

914 Dual 2 In. Gate	
923 JK Flip Flop	3 for \$2.00

709-710-711 AMPLIFIER SET

Includes one 709 operational, one 710 High Speed Differential, and one 711 Dual Comparators. Flat pak case. Brand new.

Only \$1



15¢ CATALOG on Fiber Optics, 'ICs', Semi's, Parts

Terms: add postage. Rated: net 30, cod's 25¢

Phone Orders: Wakefield, Mass. (617) 245-3R29

Retail: 211 Albion St., Wakefield, Mass.

POLY PAKS P.O. BOX 942 R
LYNNFIELD, MASS 01940

LIVE IN THE WORLD OF TOMORROW... TODAY! NEW PRODUCTS, NEW MATERIALS, NEW IDEAS!

UNUSUAL ECOLOGICAL & PHYSICAL SCIENCE BUYS

UNIQUE HARD-TO-FIND BARGAINS FOR FUN, STUDY OR PROFIT

NEW ELECTRONIC CALCULATOR—\$199.50



Really terrific imported value. Loaded with big machine capabilities. 1st truly personal electronic calculator. Absolutely silent answers in milliseconds. Use it anywhere—AC/DC. Only 3 lbs.—6.9x2" high. Add, subtract, multiply, divide, perform mixed calculations, 3 digit entry & read-out w/16-digit cap. Auto. Precise to the decimal. Features underflow, zero suppression, minus signal for true credit balance, error correction, keyboard roll over memory. Solid state reliability, modular constr. 1 year guar. for normal use. Stock No. 78,000EH \$199.50 Ppd.

1st LOW-COST VACUUM PUMP!



Nothing like it! Top-quality hand-held pump produces & maintains 25" of vacuum. Has instant release tab, 1 1/2" diam. stainless gauge (0-30"). 100's of uses—siphon noxious fluids, evacuate bell jars and castings, clean, retrieve, lift, sterilize objects, demonstrate Magdeburg hemispheres, bleed fuel lines, check leaks, etc. Lifts 40 lbs. with included "T" Lifter (2 1/2" diam. cup)—much more w/larger cup. Stock No. 71,274EH \$12.00 Ppd. Stock No. 71,300EH (without gauge/lifter) 5.50 Ppd.

BLACK-LIGHT MIGHTY MITES



Relatively small (12") fixtures give surprisingly bright blacklight. Mirror-finished reflector makes instant starting 8-watt high-intensity bulb look like 40-watt. Up to 5,000 hours of safe, long-wave (3660A) black-light to really turn-on parties, light & theatrical shows, psychedelic decors, holiday decorations. Shockproof end-caps remove for safe, easy replacement of bulb and starter. Stands upright or horizontal. Alum. case. Stock No. 71,274EH \$14.95 Ppd. DELUXE OUTDOOR/INDOOR MODEL \$19.95 Ppd. Stock No. 71,299EH

BUILD A WORKING CRYSTAL RADIO



Bring the '30's back with the fun of a modernized earphone crystal set that receives 1 or more stations! So simple you can have it working in less than an hour. Connects to a permanently fixed germanium crystal. Kit incs: 4-3/4" X 6-3/4" X 3/4" thick plywood base, high-Q tuning coil, germanium diode, variable condenser, all radio parts, earphone & holder plus diagram & simple instrs. A charming conversation piece, great fun at parties and ideal gift. Stock No. 71,513EH \$5.95 Ppd.

NUMERICAL INDICATOR TUBES



Designed as direct line, side-view readout devices for basic counter and computer circuits. Gas filled cold-cathode numerical readout tubes use common anode, 10 cathodes in shapes of numerals 0-9. Also gives visual digital display of volts, cycles, etc. High reliability, long life; wide-angle viewing with brightness and stability. TUBE W/O DECIMAL: No. 41,593EH \$5.95 Ppd. Socket for above: No. 41,616EH 80¢ Ppd. TUBE W/DEC-TO-LEFT: No. 41,618EH \$5.95 Ppd. Socket for above: No. 41,617EH 80¢ Ppd.

TAPE-SLIDE SYNCHRONIZER



Coordinate tape recordings with slide series. Hook up stereo recorder to remote control projector and TSS—then record what you wish for each slide. Playback and TSS AUTOMATICALLY changes slides in synch. w/tape. Your presentation "gives itself". Perfect for sales meetings, lectures, & vacations. Parties anywhere. Stock No. 41,222EH \$21.95 Ppd. 6-FT CONNECTOR CORDS \$4.75 Ppd. each Kodak Proj. (#60,804EH) Allright (#60,805EH)

MAIL COUPON FOR GIANT FREE CATALOG

148 PAGES—1000's OF BARGAINS Completely new 1972 edition. New items, categories, illustrations. Dozens of electrical and electromagnetic parts, accessories. Enormous selection of astronomical telescopes, Unique lighting and ecological items. Microscopes, Binoculars, Magnifiers, Magnets, Lenses, Prisms. Many war surplus items. Mail coupon for catalog "EH" EDMUND SCIENTIFIC CO. 300 EDSCORP BUILDING BARRINGTON, N.J. 08007

NAME _____
ADDRESS _____
CITY _____ STATE _____ ZIP _____

AMAZING NEW WANKEL ENGINE KIT!



Thrill to the fun of building your own see-through motorized model of revolutionary pistonless type engine. Only engine experts think economically modifiable to meet new pollution standards. Replaces piston cylinder, crank assemblies with rotating discs (sections removed for firing chambers). Smaller than conventional; fewer parts, greater reliability, same speed w/less horsepower. Switch. Req. 2-1.5V batt. (not incl.). Stock No. 71,424EH (4 1/2" x 5" x 9") \$6.75 Ppd.

NEW! ELECTRONIC DIGITAL COMPUTER KIT!



Solve problems, play games, predict weather with this actual working model of giant electronic brains. Amazing new fun way to learn & experiment with computer programming—logic, decimal, binary systems. Laws of Sets—even do your own programming after completing simplified 116 page instructive booklet. Includes step-by-step assembly diagrams. Circuits easily changed. Readout from illuminated control panel. Req. 2 "D" batt. (not incl.). Best model we've seen—for home, school, industry. Stock No. 71,434EH (11" x 12 1/2" x 4") \$31.50 Ppd.

EMOTION METER "TESTS" YOU



Amazing lie detector type device that really works. Reveals hidden likes, dislikes. Easy to use. Sensitive and accurate. Measures changes in body resistance caused by changes in emotional state. Needle movement indicates emotional response (not whether favorable or unfavorable). Effectiveness depends on questions asked and interpretation. Unique 10-oz. set intended strictly for entertainment, education. Great fun at parties. Incis. 9v battery, compl. instrs. Stock No. 41,422EH \$15.95 Ppd.

POWER HORN BLASTS A MILE



Frighten prowlers, muggers, vicious dogs with 118 decibels. Just press and this Freon powered pocket-sized metal horn can be heard a mile away to signal for help or fun. Great for boating (if floats), hiking, camping, hunting, seashore, rooting for your team. Can be heard over traffic and constr. noises to sound fire drill, lunch break or emergency. Weighs only 3 oz. but contains up to 100 mile-piercing blasts. Stock No. 41,423EH \$3.25 Ppd. 2 Refill Cartrs. (P-41,424EH) \$2.75 Ppd.

FLEXIBLE IMAGE TRANSMITTER



Hi-resolution image-transmitter lets you see into remote, inaccessible illuminated areas; through pipes, tubes or any 3/4" opening no matter how intricate. Provides clear, wide sighting. 7x magnifying eyepiece focuses from less than 1/2" from subject to infinity. Ideal for monitoring hazardous processes, surveillance instrument, demonstrate fiber optics. Over 4,000 coherent glass fibers (.002") .3% dia. semi-rigid goose-neck sheathing. Stock No. 60,857EH \$40.00 Ppd.

NEW LIGHT-EMITTING-DIODE KIT

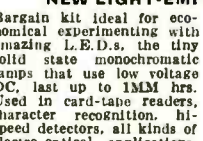

Bargain kit ideal for economical experimenting with amazing L.E.D.s, the tiny solid state monochromatic lamps that use low voltage DC, last up to 1MM hrs. Used in card-tape readers, character recognition, hi-speed detectors, all kinds of electro-optical applications. Kit incs 3 L.E.D.s: gallium arsenide (MLED 600, MV 50, MLED 930); 2 visible red emitting (6600 A°); 1 infra-red emitting (9000 A°); 6 resistors; 1' 20mm plastic fibre optic light pipe; instrs. Stock No. 41,597EH \$5.95 Ppd.

NEW \$99.50 HELIUM-NEON LASER!



Completely assembled, instant-starting w/3X power output of comparable models. Steady, ripple-free light of moderate (safe) power. Excellent collimation. Simple and safe to use. 4 1/2 lb. unit reaches 75% power in 2 secs.; 100%, typically 0.5 milliwatt (0.3 mW minimum) in 3 mins. Beam divergence 2 milliradians—2 cms at 40 ft. Stock No. 79,004EH \$99.50 Ppd. SINGLE MODE LASER No. 79,008EH \$131.50 Ppd.

TREMENDOUS WAR SURPLUS VALUE in excellent condition. Mark 57, Mod 0, 1-meter Erect Image Coincidence Rangefinder—ranges from 100-10,000 yds., accurate to 12-arc seconds. Optics & mount alone worth more than price. Fabulous precision optical instrument. 5 1/2" x 7" dia. Yellow, dark neutral, polarizing & clear ray glass filters. Non-magnetic constr.; 2 bearing mounting surfaces (1 1/4 x 5 1/4" O.D. & 1 1/4 x 5 1/2" O.D.). Storage box, instrs. Stock No. 85,208EH (Shopp. WT.-200-lbs.) ... \$450.00 F.O.B. \$1,250 HAND HELD 50 CM MODEL Stock No. 85,213EH (Shopp. WT.-11-lbs.) ... \$600.00 F.O.B.

PRECISION MICRO SCREWDRIVERS

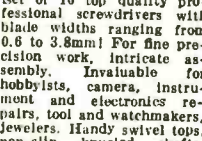

Set of 10 top quality professional screwdrivers with blade widths ranging from 0.8 to 3.8mm! For fine precision work, intricate assembly. Invaluable for hobbyists, camera, instrument and electronics repairs, tool and watchmakers, jewelers. Handy swivel tops, non-slip knurled shafts, tempered steel blades. Width of blade clearly marked on each screwdriver. Convenient see-through plastic pouch. Stock No. 41,617EH \$4.00 Ppd.

ELECTRONIC REMOTE CONTROL

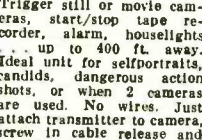

Trigger still or movie cameras, start/stop tape recorder, alarm, houselights, up to 400 ft. away. Ideal unit for selfportraits, candid, dangerous action shots, or when 2 cameras are used. No wires. Just attach transmitter to camera, screw in cable release and shoot! (Not for elec-eye cameras but operates on manual setting). Receiver, transmitter, cable release; POLAROID ADAPTER, elec. adapter cord & instrs. Req. 1 9v trans. 4 AA batt (not incl.). Stock No. 1620EH \$51.50 Ppd.

TEST AIR, WATER, LAND POLLUTION

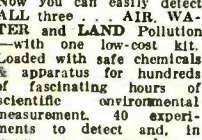

Now you can easily detect ALL three... AIR, WATER and LAND Pollution—with one low-cost kit—loaded with safe chemicals & apparatus for hundreds of fascinating hours of scientific environmental measurement, 40 experiments to detect and, in many cases, measure degree of 5 major pollutants; measure alkalinity and acidity levels. Also instrs. in biodegradables, anti-litter activity. Ideal introduction to ecology and good citizenship. Includes 48-page illustrated instruction booklet. Stock No. 71,548EH \$9.95 Ppd.

NEW "SEE-THRU" SIGHT LIGHT!



Ingenuous see-thru flashlight lights up difficult-to-see-into areas. Puts a beam of light along your line of sight in spots you couldn't previously look into & illuminate simultaneously. Hundreds of uses at home, on the job. Use for pipes, sockets, engine parts, auto parts, gun barrels, recessed areas. Ideal for factory, workshop, mechanics, plumbers, electricians, sportsmen, hobbyists, doctors and dentists. Use it also as an all-purpose flashlight. Stock No. 71,534EH \$3.95 Ppd.

\$8.95 ELECTRONIC STROBE!



Hand-sized solid state electronic strobe light at fantastically low price. Produces bright, psychedelic effects like larger, far more expensive Xenon strobes, yet it's just 2-3/4" x 4 x 1-1/2" thick. Adjustable flash rate, approximately 3-10 flashes per second. Make stop motion effects, posters come alive. Great to take with you to parties, dances, outings, etc. (Requires 2 9v transistor batt. (not incl.)). Instructions. Stock No. 41,443EH \$8.95 Ppd. 4 REPLACEMENT LAMPS P-41,444EH ... \$1.00 Ppd.

"FISH" WITH A MAGNET

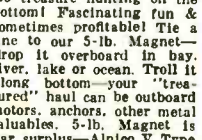

Go treasure hunting on the bottom! Fascinating fun & sometimes profitable! Tie a line to our 5-lb. Magnet—drop it overboard in bay, river, lake or ocean. Troll it along bottom—your "treasured" haul can be outboard motors, anchors, other metal valuables! 5-lb. Magnet is war surplus—Alnico V Type—Gov't. cost \$50. Lifts over 150 lbs. on land—much greater weights under water. Stock No. 70,571EH \$14.00 Ppd. Stock No. 70,570EH 3-1/2 LBS \$8.75 Ppd. Stock No. 85,152EH 15-3/4 LBS \$33.95 F.O.B.

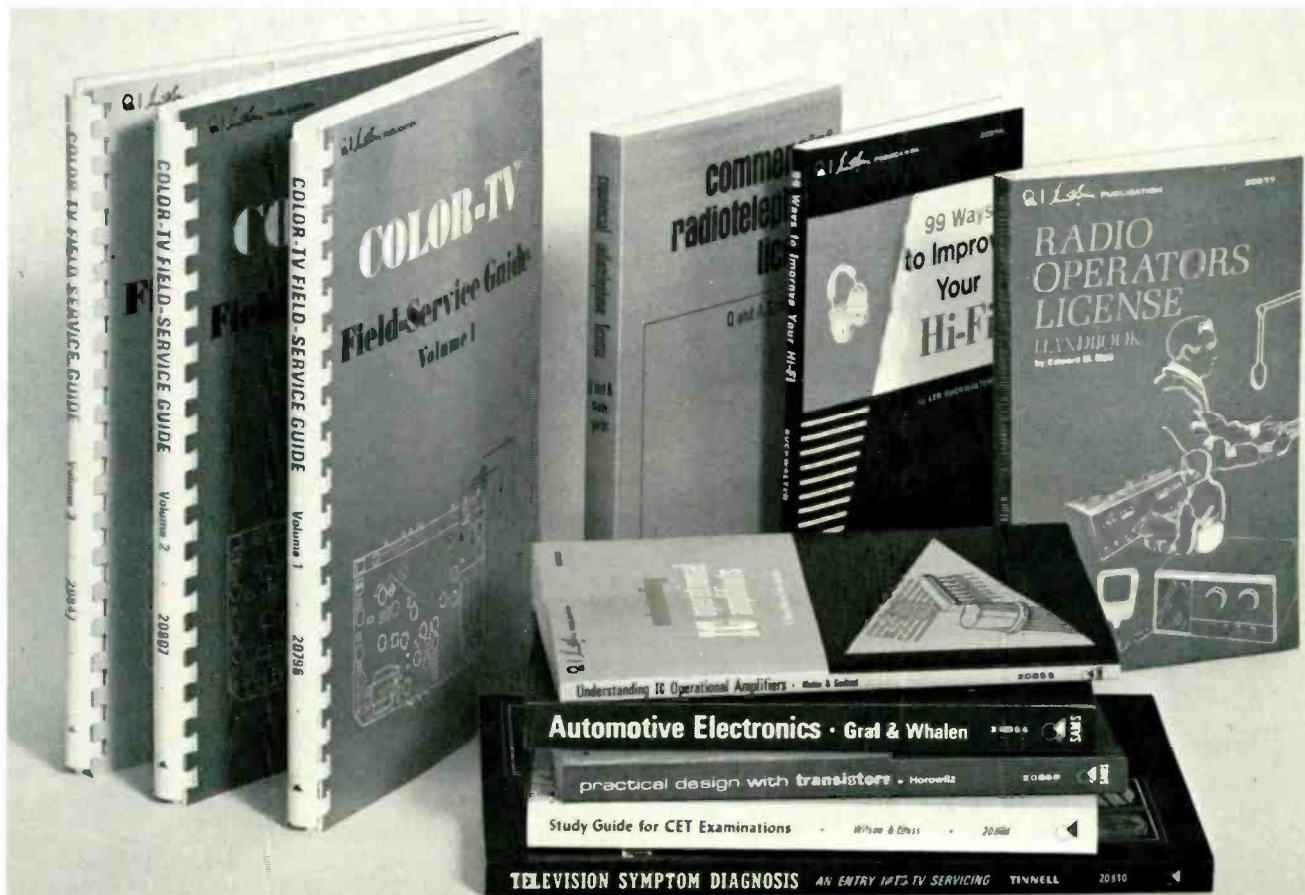

"Best Seller" Electronics Guides

Color-TV Field-Service Guides

Invaluable for servicing color-tv in the customer's home. Each volume contains 80 diagrams covering over 3,000 chassis... sensibly organized with detailed chassis layout charts on one page and specific adjustment procedures on opposite page. Indexed for instant reference.

No. 20864 (3 Vol. set)\$14.85
 No. 20796 (Vol. 1)\$4.95
 No. 20807 (Vol. 2)\$4.95
 No. 20847 (Vol. 3)\$4.95

Study Guide for CET Examinations

By J. A. Wilson, CET, and Dick Glass, CET
 A comprehensive review of the material covered by the CET (Certified Electronics Technician) examination. It's almost a "must" for gaining a CET designation, for passing a state or local licensing exam, or for a "brushing-up" when applying for a position in the electronics field. Includes question-and-answer sections and a 50-question test in each chapter.
 No. 20834\$5.95

99 Ways to Improve Your Hi-Fi

By Len Buckwalter
 This book covers many methods—many of them simple, little- or no-cost adjustments—for improving your hi-fi and stereo sound systems. All-inclusive coverage from the antenna to the speaker is divided into ten sections and supplemented, wherever necessary, by photos and illustrations. Basic or elementary knowledge, simple tools and equipment are all that is needed to make the most of the suggested innovations.
 No. 20876\$3.50

Understanding IC Operational Amplifiers

By Roger Melen and Harry Garland
 This book explains how IC op amps work and how they can be used in many practical cir-

cuits. Discusses in detail basic semiconductor electronics, integrated op amp circuitry, practical design considerations in circuits using IC op amps, bias current, offset voltage, frequency compensation, slew rate, and more.
 No. 20855\$3.95

Commercial Radiotelephone License Q and A Study Guide

By Woodrow Smith and Robert Welborn
 This comprehensive study guide contains questions taken from the first four elements of past and present Government publications of "Study Guide and Reference Material for Commercial Radio Operator Examinations," and thus presents questions used in FCC examinations.
 No. 24027\$5.95

Practical Design with Transistors—2nd Edition

By Mandle Horowitz
 This new and updated edition provides engineers and technicians with enough factual material to complete independent circuit designs. With the aid of this book, anyone with a working knowledge of algebra and radio electronics should have no difficulty in designing a transistor circuit.
 No. 20868\$6.95

Radio Operators License Handbook—2nd Edition

By Edward M. Noll
 Covers the laws, rules, regulations, and ac-

cepted operating procedures for the non-licensed operator, as well as the licensed operator. Questions and answers based on the FCC exams for Elements I, II, and IX enable the reader to prepare for any FCC license up to, but not including, the Second-Class license. It is an invaluable study guide for obtaining Third-Class license with Broadcast Endorsement. This book is a complete and indispensable reference for the marine radio telephone, aviation radio, citizens band or broadcast operator.
 No. 20877\$3.95

Automotive Electronics

By Rudolf F. Graf and George J. Whalen
 This book presents a complete picture of all the applications of electronics in a modern automobile. The electronic system of the automobile is divided into several smaller systems and each is explained in detail. A chapter on test equipment and its use will be very helpful to those who like to do their own troubleshooting and repair.
 No. 20856\$6.95

Television System Diagnosis

By Richard W. Tinnell
 A complete training program providing the necessary job-entry skills for students without previous knowledge of electronics circuitry. Upon completion of the course, the student is qualified to efficiently repair an inoperative black-and-white or color receiver.
 No. 20810\$6.95

When it comes to electronics, let a book in the modern Sams Technical Library be your guide. Send for our free catalog.

HOWARD W. SAMS & CO., INC.
 4300 West 62nd Street, Indianapolis, Indiana 46268

Order from your Electronics Parts Distributor, or mail to Howard W. Sams & Co., Inc.

Send books checked at right. \$_____ enclosed.
 Please include sales tax where applicable.

Send FREE 1972 Sams Book Catalog

Name _____
 (Please Print)

Address _____

City _____ State _____ Zip _____

20796 20855
 20807 24027
 20847 20868
 20864 20877
 20834 20856
 20876 20810

RE-022

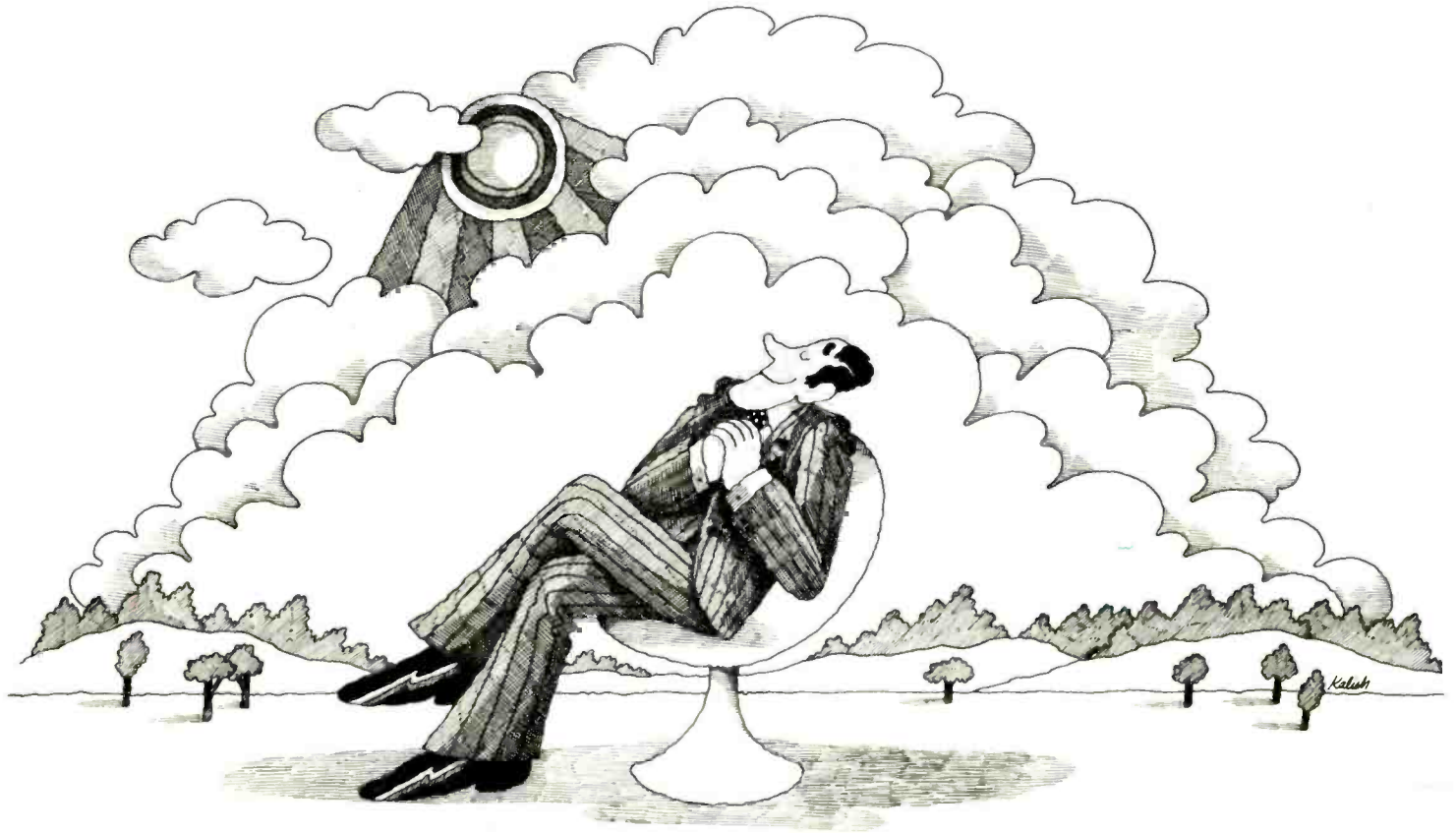

Ecstasy. At a price that won't cause too much agony.

Before the ecstasy of listening to your new stereo equipment comes, alas, the agony of shopping for it—the frustration of wanting this feature, and that spec. and finding that your budget won't quite cover it.

Sony has something to ease the pain. The STR-6036. An FM Stereo/AM-FM receiver for the man with a small room, a small budget, but big ears nonetheless.

It's an inexpensive receiver that doesn't sacrifice performance, specifications, control flexibility, sound quality, or even looks.

What it does sacrifice, of course, is just a bit of power. The STR-6036 delivers 50 clean watts of IHF dynamic power at 4 ohms*. That's quite enough to drive even most low-efficiency "bookshelf" speakers, even if it's not enough to rival the power company,

or to let you bust your buttons bragging about it.

The tuner, though, makes no concessions: It has a sensitive, overload-proof FET front end. And ceramic i.f. filters that increase selectivity and never need realignment. Plus a tuning meter for both AM and FM.

The controls have all the flexibility you'd expect from Sony: tape monitor, main/remote speaker selector, switchable loudness, even front-panel microphone input jacks.

And the control feel is typical Sony, too—firm, silky-smooth and positive. So the pleasure begins at your fingertips, even before your ears can start

enjoying. Your pleasure will deepen to ecstasy when you hear the low price. As will your dealer's when you buy one. Sony Corporation of America, 47-47 Van Dam Street, Long Island City, N.Y. 11101.

*IHF standard constant supply method.

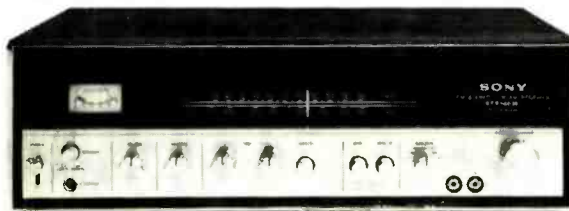

The **SONY**® 6036 Stereo Receiver

Circle 89 on reader service card